

MT1000A
Transport Modules
Operation Manual

11th Edition

**For safety and warning information, please read this manual before attempting to use the equipment.
Keep this manual with the equipment.**

ANRITSU CORPORATION

Document No. M-W3933AE-11.0

MT1000A
Transport Modules
Operation Manual

15 May 2017 (First Edition)
28 August 2019 (11th Edition)

Copyright © 2017-2019, ANRITSU CORPORATION.
All rights reserved. No part of this manual may be reproduced without the prior
written permission of the publisher.
The contents of this manual may be changed without prior notice.
Printed in Japan

About This Manual

This operation manual describes both the basic operation of the MT1000A Network Master Pro as well as the operations available via interface options and predefined applications/tests.

MT1000A Transport Modules Operation Manual (this manual)

Operations for the MT1000A Network Master Pro mainframe, 10G Multirate module (MU100010A), 100G Multirate module (MU100011A) and High Performance GPS Disciplined Oscillator (MU100090A) are described.

MT1000A Network Master Pro Transport Modules Quick Reference Guide

A printed quick user's guide that introduces the basic operation of the instrument.

MT1000A Network Master Pro MT1100A Network Master Flex Remote Scripting Operation Manual

Operations of the command-based Remote Control function are described.

Manual structure

The contents of the manual are structured in the following way:

- Chapter 1 - Introduction**
- Chapter 2 - Configuration**
- Chapter 3 - Human-Machine-Interface**
- Chapter 4 - Graphical User Interface**
- Chapter 5 - SDH/SONET/PDH/DSn Applications**
- Chapter 6 - Ethernet Application**
- Chapter 7 - OTN Applications**
- Chapter 8 - CPRI/OBSAI Applications**
- Chapter 9 - Fibre Channel (FC) Applications**
- Chapter 10 - Utility Applications**
- Chapter 11 - Specifications**
- Chapter 12 - Support**

Chapter 4 consists of a general introduction to the GUI. Chapters 5-9 contain descriptions of each screen, sub-screen and major dialog. The descriptions are provided in the following order:

Setup and result screens for each application. The applications are described in the same order as they appear on the application selector screen.

Ports setup screens and status information for each interface type.

Sub-screens and dialogs boxes are described under the main screen from which they are activated/launched.

This operation manual assumes the reader has the following basic knowledge:

Ethernet, SDH/SONET, PDH/DSn, OTN, CPRI/OBSAI, Fibre Channel, handling optical parts

Table of Contents

0 Table of Contents	4
1 Introduction	11
1.1 Mainframe	12
1.2 10G Multirate Module	13
1.3 100G Multirate Module	13
1.4 High Performance GPS Disciplined Oscillator	14
1.5 Symbols and Conventions	15
1.5.1 Symbols Used in Manual	15
1.5.2 Safety Symbols Used on Equipment	15
1.5.3 Notes	15
1.5.4 Hints	15
1.5.5 Option	16
1.6 For Safety	17
1.6.1 Dangers	17
1.6.2 Warnings	17
1.6.3 Cautions	18
1.6.4 Cautions Against Computer Virus Infection	19
1.7 Precautions	20
1.7.1 Installation	20
1.7.2 Ventilation	20
1.7.3 ESD (Electrostatic Discharge)	21
1.7.4 Optical Surfaces	21
1.7.5 Cautions on Handling Optical Fiber Cables	22
1.7.6 Caution when handling MU100090A	23
1.7.7 Countries and Regions Permitting WLAN Use	23
2 Configuration	25
2.1 Delivered Accessories	26
2.1.1 Standard Accessories	26
2.1.2 Optional Accessories	26
2.2 Mains Power Adapter	28
2.2.1 Connecting Mains Power Adapter	28
2.3 Rechargeable Battery	29
2.3.1 Installing or Replacing Battery	29
2.3.2 Charging Battery	30
2.3.3 Battery Status Information	31
2.4 Measurement Cables	32
2.4.1 Connecting Measurement Cables	32
2.5 Support Stand and Carrying Strap	33
2.5.1 Support Stand	33
2.5.2 Carrying Strap and Handle	33
2.6 Modules Configuration	37
2.7 How to Attach the MU100090A	38
2.7.1 Replacing the MU100010A 10G Multirate modules	38
2.7.2 Attaching the MU100090A and MU100010A	39
3 Human-Machine-Interface	41
3.1 Touch Screen Display	42
3.2 Key Operation	43
3.2.1 Power Button	43
3.3 Head Set	45
3.4 Connector Panel	46
3.4.1 Test Interfaces	46
3.4.2 Service Interfaces	47
3.4.3 GPS Disciplined Oscillator Interfaces	48
3.5 Remote Operation	50

3.5.1	Installation of Control Software	50
3.5.2	Connection and Setup	50
3.5.3	Communication Ports	51
3.5.4	Starting Control Software	52
3.5.5	Remote Upgrade	54
3.5.6	Remote Power Control	54
3.5.7	Remote Reset	55
3.5.8	Stand-alone Editor	55
3.6	Command-Based Remote Control	57
3.7	In-band Control	57
3.8	File Access via USB Interface	58
3.9	File Access via Ethernet Interface	59
3.9.1	Accessing files in Network Master from the PC	59
3.9.2	Mounting the Shared Folder of Networked PC to the Network Master	59
3.10	GPS Receiver	62
3.10.1	G0325A GPS Receiver	62
3.10.2	MU100090A GPS Disciplined Oscillator	62
3.10.3	Operating GPS Receiver	63
3.11	Remote Control via GPIB	64
4	Graphical User Interface	65
4.1	General Handling of the GUI	66
4.1.1	GUI Concept	66
4.1.2	Navigating in the GUI	67
4.1.3	Layout of the GUI Screens	68
4.1.4	Lamp Indication of Alarm/Error Status	75
4.1.5	Keypads for Entering Text in Fields	77
4.1.6	User Pattern Editor	78
4.1.7	Prompts to Confirm Dependencies	78
4.2	Toolbars	79
4.2.1	Instrument Toolbar	79
4.2.2	Application Toolbar	92
4.3	Startup and Switch-off Sequences	97
4.3.1	Instrument Startup	97
4.3.2	Application Startup	97
4.3.3	Accessing Previous Tests and Test Results	98
4.3.4	Closing an Application	98
4.3.5	Switching Off the Instrument	99
5	SDH/SONET/PDH/DSn Applications	101
5.1	SDH Setup and Status	102
5.1.1	Transmitter Setup	102
5.1.2	Receiver Setup	107
5.1.3	Status Information	109
5.1.4	Errors/Alarms Insertion	115
5.2	SONET Setup and Status	118
5.2.1	Transmitter Setup	118
5.2.2	Receiver Setup	123
5.2.3	Status Information	125
5.2.4	Errors/Alarms Insertion	127
5.3	E1 Setup and Status	128
5.3.1	Transmitter Setup	128
5.3.2	Receiver Setup	134
5.3.3	Status Information	139
5.3.4	Errors/Alarms Insertion	145
5.4	DS1/J1 Setup and Status	147
5.4.1	Transmitter Setup	147
5.4.2	Receiver Setup	152

5.4.3 Status Information	155
5.4.4 Errors/Alarms Insertion	158
5.5 E3 Setup and Status	159
5.5.1 Transmitter Setup	159
5.5.2 Receiver Setup	161
5.5.3 Status Information	163
5.5.4 Errors/Alarms Insertion	164
5.6 DS3 Setup and Status	165
5.6.1 Transmitter Setup	165
5.6.2 Receiver Setup	169
5.6.3 Status Information	171
5.6.4 Errors/Alarms Insertion	174
5.7 E4 Setup and Status	175
5.7.1 Transmitter Setup	175
5.7.2 Receiver Setup	177
5.7.3 Status Information	178
5.7.4 Errors/Alarms Insertion	179
5.8 APS	180
5.8.1 Ports Setup and Status	180
5.8.2 Test Setup	180
5.8.3 Test Results	181
5.9 BERT	185
5.9.1 Ports Setup and Status	185
5.9.2 Test Setup	185
5.9.3 Test Results	190
5.10 RTD	203
5.10.1 Ports Setup and Status	203
5.10.2 Test Setup	203
5.10.3 Test Results	204
6 Ethernet Applications	207
6.1 Ethernet Setup and Status	208
6.1.1 Physical Port Setup	208
6.1.2 Ethernet Frame Setup	214
6.1.3 Status Information	271
6.1.4 Errors/Alarms Insertion	290
6.2 BERT	294
6.2.1 Ports Setup and Status	294
6.2.2 Test Setup	294
6.2.3 Test Results	308
6.3 Cable	318
6.3.1 Test Setup	319
6.4 Channel Statistics	320
6.4.1 Ports Setup and Status	320
6.4.2 Test Setup	320
6.4.3 Test Results	321
6.5 Mon/Gen	324
6.5.1 Ports Setup and Status	324
6.5.2 Test Setup	324
6.5.3 Test Results	332
6.6 Pass Through	338
6.6.1 Ports Setup and Status	338
6.6.2 Test Setup	339
6.6.3 Test Results	340
6.7 Ping	341
6.7.1 Ports Setup and Status	341
6.7.2 Test Setup	341
6.7.3 Test Results	342

6.8 Reflector	344
6.8.1 Ports Setup and Status	344
6.8.2 Test Setup	345
6.8.3 Test Results	346
6.9 RFC 2544	347
6.9.1 Ports Setup and Status	347
6.9.2 Test Setup	348
6.9.3 Test Results	361
6.9.4 Throughput Calculation	365
6.10 RFC 6349	367
6.10.1 Ports Setup and Status	367
6.10.2 Test Setup	368
6.10.3 Test Results	373
6.11 SAT 1564	378
6.11.1 Ports Setup and Status	378
6.11.2 Test Setup	378
6.11.3 Test Results	388
6.12 Traceroute	392
6.12.1 Ports Setup and Status	392
6.12.2 Test Setup	393
6.12.3 Test Results	394
6.13 Sync Test	395
6.13.1 Ports Setup and Status	397
6.13.2 Test Setup	398
6.13.3 Test Results	401
6.14 Discovery	411
6.14.1 Ports Setup and Status	412
6.14.2 Test Setup	412
6.14.3 Test Results	413
6.14.4 Procedure	415
7 OTN Applications	419
7.1 OTN Setup and Status	420
7.1.1 Transmitter Setup	420
7.1.2 Receiver Setup	436
7.1.3 Status Information	441
7.1.4 Error/Alarm Insertion	448
7.2 APS	453
7.2.1 Ports Setup and Status	453
7.2.2 Test Setup	453
7.2.3 Test Results	454
7.3 BERT	457
7.3.1 Ports Setup and Status	457
7.3.2 Test Setup	457
7.3.3 Test Results	461
7.4 RTD	467
7.4.1 Ports Setup and Status	467
7.4.2 Test Setup	467
7.4.3 Test Results	468
8 Mobile xHaul Applications	471
8.1 CPRI/OBSAI Setup and Status	472
8.1.1 Physical Port Setup	473
8.1.2 CPRI/OBSAI Frame Setup	475
8.1.3 Status Information	477
8.1.4 Error/Alarm Insertion	481
8.2 CPRI/OBSAI BERT	483
8.2.1 Ports Setup and Status	483
8.2.2 Test Setup	483

8.2.3 Test Results	486
8.3 CPRI P. Through	491
8.3.1 Ports Setup and Status	491
8.3.2 Test Setup	491
8.3.3 Test Results	491
8.4 eCPRI/RoE BERT	493
8.4.1 Enable 25 Gbps bit rate for two ports in eCPRI/RoE BERT application	493
8.4.2 Ports Setup and Status	494
8.4.3 Test Setup	503
8.4.4 Test Results	503
9 Fibre Channel (FC) Applications	507
9.1 Fibre Channel Setup and Status	508
9.1.1 Physical Port Setup	509
9.1.2 Fibre Channel Frame Setup	510
9.1.3 Status Information	514
9.1.4 Errors/Alarms Insertion	516
9.2 BERT	518
9.2.1 Ports Setup and Status	518
9.2.2 Test Setup	518
9.2.3 Test Results	523
9.3 Performance	528
9.3.1 Ports Setup and Status	528
9.3.2 Test Setup	529
9.3.3 Test Results	536
9.4 Reflector	541
9.4.1 Ports Setup and Status	541
9.4.2 Test Setup	541
9.4.3 Test Results	542
10 Device Test Applications	547
10.1 Device Test Setup and Status	548
10.1.1 Physical Port Setup	548
10.1.2 Status Information	549
10.1.3 Errors/Alarms Insertion	550
10.2 No Frame Test	552
10.2.1 Ports Setup and Status	552
10.2.2 Test Setup	552
10.2.3 Test Results	553
11 Utility Applications	557
11.1 Scenario	558
11.1.1 Scenario Manager	558
11.1.2 Running the Scenario	560
11.2 GPS	562
11.2.1 Test Setup	562
11.2.2 Test Results	562
11.3 PDF Viewer	565
11.4 VIP	566
11.4.1 Application Toolbar	566
11.4.2 Connecting the Video Inspection Probe	566
11.4.3 Test Setup	567
11.4.4 Test Results	570
11.5 Wireshark	572
12 Specifications	575
12.1 MT1000A	576
12.1.1 Configuration	576

12.1.2 External Interfaces	577
12.1.3 Other Interfaces	577
12.1.4 Environment Performance	578
12.1.5 Mechanical Performance	578
12.2 MU100010A 10G Multirate Module	579
12.2.1 Configuration	579
12.2.2 External Interfaces	580
12.2.3 Environment Performance	583
12.2.4 Mechanical Performance	584
12.3 MU100011A 100G Multirate Module	585
12.3.1 Configuration	585
12.3.2 External Interfaces	586
12.3.3 Environment Performance	588
12.3.4 Mechanical Performance	589
12.4 MU100090A High Performance GPS Disciplined Oscillator	590
12.4.1 Configuration	590
12.4.2 Electrical performance and function	590
12.4.3 GPS Synchronization	591
12.4.4 Environment Performance	591
12.4.5 Mechanical Performance	591
12.5 Measurement Functionality	592
12.5.1 Ethernet Measurements	592
12.5.2 SDH/SONET/PDH/DSn	604
12.5.3 OTN	615
12.5.4 Fibre Channel	624
12.5.5 CPRI/OBSAI	625
12.5.6 Device Test	627
12.6 Optical Modules	629
13 Support	633
13.1 Maintenance and Cleaning	634
13.1.1 Maintenance	634
13.1.2 Cleaning	634
13.1.3 Storage	634
13.2 Calibration	636
13.3 Formatting the data area in the Network Master	637
13.4 Upgrading the Software	638
13.4.1 Installation by using USB memory stick	638
13.4.2 Installation via Network	638
13.5 Support and Service Assistance	639
13.5.1 Before you obtain assistance	639
13.5.2 Data Backup	639
13.5.3 Obtaining Support or Service Assistance	639
13.6 Transporting and Disposal	640
13.6.1 Repackaging	640
13.6.2 Transporting	640
13.6.3 Disposal	640
13.7 Special Information	641
13.7.1 Equipment Certificate	641
13.7.2 Anritsu Warranty	641
13.7.3 Anritsu Corporation Contact	642
13.7.4 Licensing Information	642
13.7.5 Availability of Source Code	642
13.8 Software License Document	643
13.9 EULA License Document	647
13.10 CE Conformity Marking	649
13.10.1 Product Model	649
13.10.2 Applied Directive	649

13.10.3 Applied Standards	649
13.10.4 Contact	650
13.10.5 CE Declaration	651
13.11 RCM Conformity Marking	652
13.11.1 Product Model	652
13.11.2 Applied Standards	652
13.12 Laser Safety	653
13.12.1 Laser Safety Classifications	653
13.12.2 Indication Labels on Product	656
13.12.3 Laser Radiation Markings	656
13.13 Wireless Certification	658
13.13.1 Japan MIC	658
13.13.2 North America (USA FCC and Canada IC)	658
13.13.3 Europe CE	659
13.13.4 Brazil ANATEL	659
13.13.5 China SRRC	660
13.13.6 Indonesia SDPPI	660
13.13.7 Israel MoC	660
13.13.8 Mexico IFETEL	661
13.13.9 Philippines NTC	661
13.13.10 Russia CU Scheme and Minsvyaz	661
13.13.11 Singapore IMDA	661
13.13.12 Thailand NTC	661
13.14 Declarations	662
13.14.1 Notes on Export Management	662
13.14.2 Information for EU and EFTA Customers Only	662
13.14.3 Information for U.S. Customers Only	662
13.14.4 Information for the Chinese Market Only	663

1 Introduction

This chapter provides a general introduction to the MT1000A Network Master Pro, and explains the symbols and conventions used in this manual.

1.1 Mainframe

The MT1000A Network Master Pro (hereafter called *the Network Master* and sometimes *the instrument*) is a battery-powered multipurpose telecommunications test instrument for field use. It is a tool for a wide range of applications from fast first-aid troubleshooting to comprehensive, in-depth analysis of transmission problems. The installed options enable the Network Master to be used both as a full-featured transmission line quality tester and as an advanced signaling analyzer.

The Network Master features a wide TFT LCD display with touch screen interface, where results are easily read and color coding and graphical symbols aid the users in system setup and results analysis. The Network Master also allows users to store applications settings to reduce time for future configurations. For fast and efficient data transfer and external communication, the Network Master houses LAN interface, *Bluetooth*[®] and three USB ports.

Fault location is greatly facilitated by the high degree of portability of the robust Network Master, allowing measurements to be taken at any suitable measuring point. Accordingly, the Network Master can be powered either by a rechargeable and replaceable intelligent high-capacity Li-Ion battery, or via mains adapter for long-term measurements.

Altogether, these features guarantee the supreme functionality of the Network Master, allowing both convenience and optimal user-friendly operation.

For latest information, refer to the homepage below.

<https://www.anritsu.com/en-us/test-measurement/products/mt1000a>



1.2 10G Multirate Module

The 10G Multirate module (MU100010A) allows the Network Master to test a large variety of interfaces and systems up to 10 Gbps, like OTN interfaces, Ethernet interfaces, SDH/SONET interfaces, Fibre Channel interfaces and PDH/DSn interfaces. The MU100010A can be configured to have two ports at all rates and interfaces. The instrument is thus ideal for both in-service and out-of-service transmission-quality measurement.

For fast troubleshooting, the Network Master displays alarms and transmission link status on Lamp icons in its display. The instrument's two ports permit immediate monitoring of the two sides of a line and allow comparison of simultaneously recorded results.

1.3 100G Multirate Module

The 100G Multirate module (MU100011A) allows the Network Master to test systems in interfaces bit rate of up to 10 Gbps, 25 Gbps, 40 Gbps, and 100 Gbps by using SFP+, SFP28, QSFP, and CFP4 optical transceivers

Supported Interfaces

Interface	MU100010A	MU100011A
10BASE-T, 100BASE-TX, 1000BASE-T	✓	✓
100BASE-XX, 1000BASE-XX, 10GBASE-XX	✓	✓
25GbE, 40GbE, 100GbE	-	✓
SDH-1/4/16/64, OC-3/12/48/192	✓	✓
E1, E3, E4, DS1/J1, DS3, SDH-1e, STS-3	✓	-
OTU-1/1e/1f/2/2e/2f	✓	✓
OTU-3/3e1/3e2/4	-	✓
FC100, FC200, FC400, FC800, FC1200	✓	✓
FC1600	-	✓
CPRI-1/2/3/4/5/6/7/8, OBSAI (768, 1536, 3072, 6144 Mbps)	✓	✓
CPRI-9/10	-	✓

✓: Supported, -: Not Supported

In a [module configuration](#) that uses a 100G Multirate module in combination with an OTDR module, CPRI module or other modules, MT1000A-006 high power supply is required for MT1000A even when measurement function of MU100011A is not used.

1.4 High Performance GPS Disciplined Oscillator

The MU100090A High Performance GPS Disciplined Oscillator provides 10 MHz reference clock in high accuracy by employing the Rubidium oscillator. By synchronizing the built-in GPS receiver output and the Rubidium oscillator, the MU100090A can output the clock and 1PPS^{*1} synchronized with UTC^{*2}. Moreover, the MU100090A allows to synchronize the Rubidium oscillator with 1PPS which is input to the "1pps Sync In" connector.

*1: One pulse per second

*2: Coordinated Universal Time

Even if Sync input signal is lost because GPS receiver cannot capture satellites (this status is "Hold over"), high stability of the Rubidium oscillator allows to keep the time accuracy.

The built-in GPS receiver can provide following:

3.3V or 5V antenna feeding

Tod (Time of Day) output in NMEA 0184 format

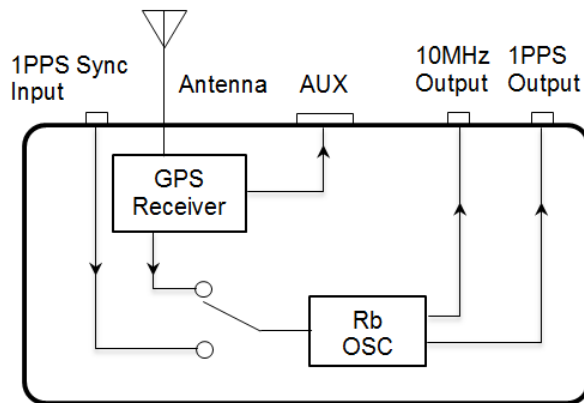

MU100090A Block Diagram

Using the MU100090A clock output to the MU100010A reference clock allows the time measurement in high accuracy. Moreover MU100090A can be used as the external GPS receiver of MT1000A.

1.5 Symbols and Conventions

1.5.1 Symbols Used in Manual

To prevent the risk of personal injury or loss related to equipment malfunction, Anritsu Corporation uses the following safety symbols to indicate safety-related information. Ensure that you clearly understand the meanings of the symbols BEFORE using the equipment. Some or all of the following symbols may be used on all Anritsu equipment. In addition, there may be other labels attached to products that are not shown in the diagrams in this manual.



DANGER

This indicates a very dangerous procedure that could result in serious injury or death if not performed properly.



WARNING

This indicates a hazardous procedure that could result in serious injury or death if not performed properly.



CAUTION

This indicates a hazardous procedure or danger that could result in light-to-severe injury, or loss related to equipment malfunction, if proper precautions are not taken.

1.5.2 Safety Symbols Used on Equipment

The following safety symbols are used on Anritsu equipment near operation locations to provide information about safety items and operation precautions. Ensure that you clearly understand the meanings of the symbols and take the necessary precautions BEFORE using the equipment.



This indicates a prohibited operation. The prohibited operation is indicated symbolically in or near the barred circle.



This indicates an obligatory safety precaution. The obligatory operation is indicated symbolically in or near the circle.



This indicates a warning or caution. The contents are indicated symbolically in or near the triangle.



This indicates a note. The contents are described in the box.



These indicate that the marked part should be recycled.

A number of typographical conventions are used for easy spotting of information. Examples below are shown in grey boxes in this section only to indicate that they are 'examples'.

1.5.3 Notes



The Note symbol indicates information, procedures or recommendations that need to be followed to make correct measurements etc. Note text is written in italics to separate the information from the other text elements on a page.

1.5.4 Hints



The Hint symbol indicates information that should be treated as hints, suggestions, recommendations etc. Hint text is written in italics to separate the information from the other text elements on a page.

1.5.5 Option



The Option symbol indicates that the information described covers an option (hardware and software) and that this option must be installed before use. Text is written in italics to separate the information from the other text elements on a page.

1.6 For Safety

This section contains warnings which should be followed to avoid personal injury, product damage, as well as damage to the environment.

1.6.1 Dangers

DANGER

Replacing Battery



- When replacing the battery, use the specified battery and insert it with the correct polarity. If the wrong battery is used, or if the battery is inserted with reversed polarity, there is a risk of explosion causing severe injury or death.

FOR CALIFORNIA USA ONLY

This product contains a CR Coin Lithium Battery which contains Perchlorate Material - special handling may apply, see www.dtsc.ca.gov/hazardouswaste/perchlorate.

Battery Disposal

- DO NOT expose batteries to heat or fire. This is dangerous and can result in explosions or fire. Heating batteries may cause them to leak or explode.

1.6.2 Warnings

WARNING



- ALWAYS refer to the operation manual when working near locations at which the alert mark shown on the left is attached. If the advice in the operation manual is not followed, there is a risk of personal injury or reduced equipment performance. The alert mark shown on the left may also be used with other marks and descriptions to indicate other dangers.

- Overvoltage Category

This equipment complies with overvoltage category II defined in IEC 61010. DO NOT connect this equipment to the power supply of overvoltage category III or IV.

- Laser radiation warning

NEVER look directly into the cable connector on the equipment nor into the end of a cable connected to the equipment. There is a risk of injury if laser radiation enters the eye.

The Laser Safety label is attached to the equipment for safety use as indicated in "[Laser Safety](#)".

Repair



- Only qualified service personnel with a knowledge of electrical fire and shock hazards should service this equipment. This equipment cannot be repaired by the operator. DO NOT attempt to remove the equipment covers or unit covers or to disassemble internal components. In addition, there is a risk of damage to precision components.

Calibration



- The performance-guarantee seal verifies the integrity of the equipment. To ensure the continued integrity of the equipment, only Anritsu service personnel, or service personnel of an Anritsu sales representative, should break this seal to repair or calibrate the equipment. Be careful not to break the seal by opening the equipment or unit covers. If the performance-guarantee seal is broken by you or a third party, the performance of the equipment cannot be guaranteed.

Battery Fluid

- DO NOT short the battery terminals and never attempt to disassemble the battery or dispose of it in a fire. If the battery is damaged by any of these actions, the battery fluid may leak. This fluid is poisonous. DO NOT touch the battery fluid, ingest it, or get in your eyes. If it is accidentally ingested, spit it out immediately, rinse your mouth with water and seek medical help. If it enters your eyes accidentally, do not rub your eyes, rinse them with clean running water and seek medical help. If the liquid gets on your skin or clothes, wash it off carefully and thoroughly with clean water.

LCD

- This equipment uses a Liquid Crystal Display (LCD). DO NOT subject the equipment to excessive force or drop it. If the LCD is subjected to strong mechanical shock, it may break and liquid may leak. This liquid is very caustic and poisonous. DO NOT touch it, ingest it, or get in your eyes. If it is ingested accidentally, spit it out immediately, rinse your mouth with water and seek medical help. If it enters your eyes accidentally, do not rub your eyes, rinse them with clean running water and seek medical help. If the liquid gets on your skin or clothes, wash it off carefully and thoroughly with soap and water.

1.6.3 Cautions

 **CAUTION**

**Replacing Memory
Back-up Battery**

This equipment uses a Poly-carbomonofluoride lithium battery to back up the memory. This battery must be replaced by service personnel when it has reached the end of its useful life; contact the Anritsu sales section or your nearest representative.

Note: The battery used in this equipment has a maximum useful life of 8 years. It should be replaced before this period has elapsed.

The life of the battery will vary depending on the length of equipment usage and the operating environment.

The following conditions may be observed if the battery has expired:

- When power to the equipment is supplied, the time display may no longer match the actual time.
- Parameter and data settings may not be retained when the power to the equipment is cut.

External Storage This equipment uses a USB memory as external storage media for storing data and programs.

If this media is mishandled or becomes faulty, important data may be lost. It is recommended to periodically back up all important data and programs to protect them from being lost accidentally.

Anritsu will not be held responsible for lost data.

Pay careful attention to the following points:

- Never remove the USB memory from the equipment while it is being accessed.
- The USB memory may be damaged by static electric charges.
- Anritsu has thoroughly tested all external storage media shipped with this equipment. Users should note that external storage media not shipped with this equipment may not have been tested by Anritsu, thus Anritsu cannot guarantee the performance or suitability of such media.

Lifetime of Parts The life span of certain parts used in this equipment is determined by the operating time or the power-on time. Due consideration should be given to the life spans of these parts when performing continuous operation over an extended period. The safety of the equipment cannot be guaranteed if component parts are used beyond their life spans. These parts must be replaced at the customer's expense even if within the guaranteed period described in Warranty at the end of this manual.

For details on life-span, refer to the corresponding section in this manual.

- | |
|--|
| <ul style="list-style-type: none"> • LCD: Brightness at 50% after 40,000hrs • Battery pack Capacity: 70% after 300 charge/discharge cycles |
|--|

Use in Residential Environment This equipment is designed for an industrial environment. In a residential environment, this equipment may cause radio interference in which case the user may be required to take adequate measures.

Use in Corrosive Atmospheres Exposure to corrosive gases such as hydrogen sulfide, sulfurous acid, and hydrogen chloride will cause faults and failures.

Note that some organic solvents release corrosive gases.

1.6.4 Cautions Against Computer Virus Infection

Copying files and data

Only files that have been provided directly from Anritsu or generated using Anritsu equipment should be copied to the instrument.

All other required files should be transferred by means of USB media after undergoing a thorough virus check.

Adding software

Do not download or install software that has not been specifically recommended or licensed by Anritsu.

Network connections

Ensure that the network has sufficient anti-virus security protection in place.

1.7 Precautions

This section contains some precautions which should be followed to avoid damage or malfunction due to incorrect use, handling and transportation of the Network Master.

1.7.1 Installation

Install MT1000A horizontally in a stable place.

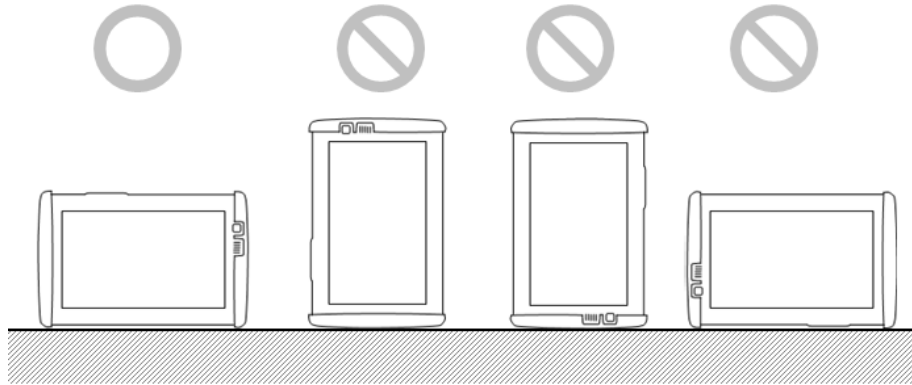

⚠ CAUTION

If the MT1000A is not installed in a "good" direction as above, a small shock may turn it over and harm the user.

MT1000A equips the support stand on the rear panel. When using MT1000A on a desk, open the [support stand](#) on the rear the panel

1.7.2 Ventilation

The instrument has built-in fans, to prevent the temperature to rise inside the instrument.

⚠ CAUTION

Be sure not to block the ventilation holes.

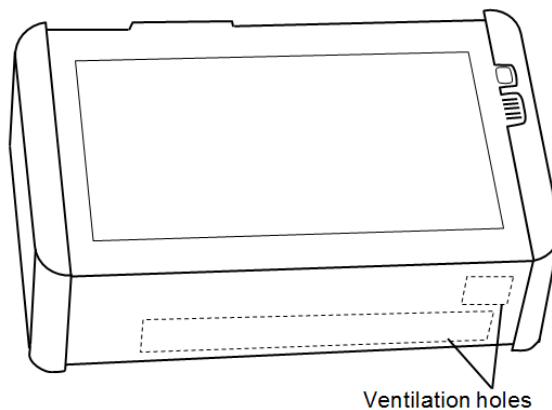

In this instrument, cooling air is taken in through the side panel, and hot air is exhausted through the bottom panel. When using MT1000A on a desk, open the [support stand](#) on the rear panel

1.7.3 ESD (Electrostatic Discharge)

Modules and options for the Network Master contain electronic devices that are sensitive to ESD (Electro Static Discharge). Therefore, all ESD sensitive items are delivered from Anritsu in antistatic shielding packages.

Electrostatic discharge during installation can result in destruction or degradation of these devices. The damage may lead to equipment failure later. When you install or remove modules, it is your responsibility to control ESD. To control ESD, take the issues described below into consideration.

 **CAUTION**

Avoid build-up of electrostatic charge

- Keep your workplace clear of any item that can generate electrostatic charges, e.g. all items that are not made of antistatic materials.

Minimize the exposure to ESD

- Keep ESD sensitive items in antistatic shielding packaging as long as possible.
- Do not remove ESD sensitive items from equipment or the antistatic shielding packaging unless you are connected to the equipment with a grounding wrist strap (as described later).
- Return ESD sensitive items to antistatic shielding packaging.

Keep equipment, the ESD sensitive items and yourself at the same static potential

- If your workplace is already prepared for handling ESD sensitive items, then follow your usual procedure. If not, you should follow the procedure below using a ground wrist strap.
 1. Attach the wrist end of the wrist strap firmly around your wrist and the other end to the equipment chassis or ground plug.
 2. Keep the wrist strap on while you install or remove ESD sensitive items. Do not remove the wrist strap until the ESD sensitive parts are either installed or returned to the antistatic shielding package.
-

1.7.4 Optical Surfaces

The optical interfaces - transmitter as well as receiver - are very sensitive to contamination. Be aware that contamination of the optical surfaces may result in severe loss of signal.

 **CAUTION**

To prevent contamination of the optical surfaces, mount protective caps to seal the transmitter/receiver connectors when no fiber optic cables are connected.

Correct functioning of the instrument can only be ensured if optical modules, supplied by Anritsu for the Network Master, are used.

1.7.5 Cautions on Handling Optical Fiber Cables

Optical fiber cables may degrade in performance or be damaged if handled improperly. Note the following points when handling them.

CAUTION

Do not pull the cable when removing the connector.

Doing so may break the optical fiber inside the cable, or remove the cable sheath from the optical connector.



CAUTION

Do not excessively bend, fold, or pinch an optical fiber cable.

Doing so may break the optical fiber inside the cable.

Keep the bend radius of an optical fiber cable at 30 mm or more. If the radius is less, optical fiber cable loss will increase.

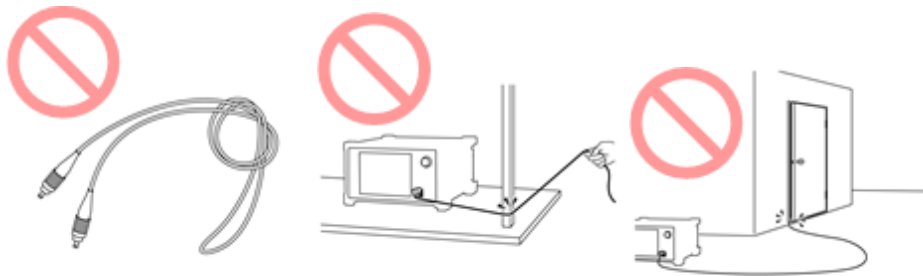

CAUTION

Do not excessively pull on or twist an optical fiber cable.

Also, do not hang anything by using a cable. Doing so may break the optical fiber inside the cable.



⚠ CAUTION

Be careful not to hit the end of an optical connector against anything hard such as the floor or a desk by dropping the optical fiber cable.

Doing so may damage the connector end and increase connection loss.



⚠ WARNING

Do not touch the end of a broken optical fiber cable.

The broken optical fiber may pierce the skin, causing injury.



⚠ CAUTION

Do not disassemble optical connectors.

Doing so may cause Rubidium oscillator to break or the performance to degrade.

1.7.6 Caution when handling MU100090A

⚠ CAUTION

Be sure not to give vibration and shock.

Doing so may cause the built-in Rubidium oscillator to damage or the performance to degrade.

1.7.7 Countries and Regions Permitting WLAN Use

Use of WLAN is restricted in some countries and regions, and illegal use may be punishable under national or local regulations. To avoid violating WLAN regulations, visit the Anritsu website to check where use is allowed.

<https://www.anritsu.com/ja-JP/test-measurement/support/downloads/brochures-datasheets-and-catalogs/dwl16689>

Note that Anritsu cannot be held liable for any problem arising from WLAN use in other countries and regions.

2 Configuration

This chapter contains information about the included accessories as well as guidelines for connecting the mains adapter, for charging the battery, and for attaching the carrying strap.

2.1 Delivered Accessories

The instrument is delivered in a shipment container together with various accessories depending on the order. When unpacking the first time, it is recommended to check these accessories against the list(s) below.

2.1.1 Standard Accessories

The following standard accessories are delivered with the instrument:

MT1000A	
J0980	A-2 Power Cord * ¹
J0981	B4 Power Cord * ¹
J0982	C7 Power Cord * ¹
J0983	S3 Power Cord * ¹
J1027	P4 Power Cord * ¹
G0310A	LiION Battery
G0385A	High Power AC Adapter
B0728A	Rear Panel Kit
B0745A	Softcase
Z1746A	Stylus
Z1747A	Carrying Strap
Z1748A	Handle
Z1817A	Utilities ROM
W3935AE	MT1000A Transport Modules Quick Reference Guide

MU100010A

B0692A	ESD box * ²
--------	------------------------

*1: One of these power cord come with according to your country.

*2: Up to four SFP+/SFPs can be stored.

MU100090A

J1705A	AUX Conversion Adaptor
J1706A	GPS Antenna
J1710A	BNC Cable (20cm)

2.1.2 Optional Accessories

One or more of the following optional accessories may be delivered with the instrument (if included in the order):

B0691B	Hard case
B0720A	Rear Cover
B0729A	Screw 1U
B0730A	Screw 2U
B0731A	Screw 3U
B0732A	Screw Kit
B0733A	Hard Case
G0306B	Video Inspection Probe
G0324A	Battery Charger
G0325A	GPS receiver
G0382A	Autofocus Video Inspection Probe
J1569B	Car 12 Vdc adapter
J1667A	GPIB-USB Converter
W3933AE	MT1000A Transport Modules Operation Manual
W3736AE	MT1000A Network Master Pro/ MT1100A Network Master Flex Remote Scripting Operation Manual

2.2 Mains Power Adapter

The Network Master can be powered from the supplied AC mains adapter.

CAUTION

Always use AC mains adapter delivered from Anritsu.

2.2.1 Connecting Mains Power Adapter

To connect the mains power adapter to the Network Master, follow the procedure below:

1. Insert the mains adapter's DC power plug into the socket connector marked '18V DC'. The DC input connector is located on the right-hand side of Network Master's connector panel.



When option 006 is installed, the area around DC input connector is marked in yellow. Connect G0385A High power DC adaptor.

When option 006 is not installed, connect G0309A DC adaptor.

2. Connect the AC plug of the mains adapter to the mains and switch on the mains wall outlet. The power button will flash fast on orange during booting. Then flashes slowly on orange when charging.

2.3 Rechargeable Battery

The Network Master is delivered with a 10.8 V Intelligent Li-Ion rechargeable and replaceable battery. The typical operation capacity (with a fully charged battery) will be approximately 4 hours.

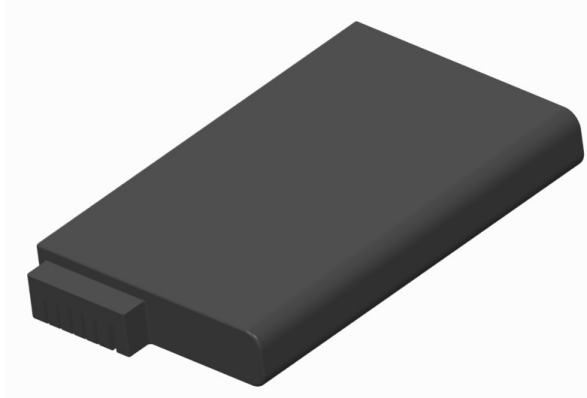

CAUTION

Use only original batteries delivered from Anritsu, to prevent the risk of instrument damage or personal injury.

Battery should only be charged at room temperature.

Initial charging

The battery will normally be partially or fully discharged on delivery. It is recommended to charge the battery immediately after delivery and unpacking. In Standby Mode, the power button will stop flashing when the battery is fully charged.



If the battery will not to be used for a long period of time, it is recommended that it contains at least 20% capacity. Charge the battery before storage, if necessary.

Temperature

When charging is in process, the temperature of the battery will increase. When the battery temperature exceeds 40 °C, the Network Master automatically stops battery charging and displays following message.



In order to resume battery charging as soon as possible, use the Network Master in the environment with lower ambient temperature. Or, close the application and shut down the Network Master.



If the battery temperature reaches 60°C or over while Network Master is in battery operation, Network Master shuts down automatically. In this case, leave the Network Master for approximately one hour to cool itself at room temperature (around 25°C) before using Network Master again.

2.3.1 Installing or Replacing Battery

To install or replace the battery in the Network Master, follow the procedure below:

1. Disconnect the mains power adapter if it is connected.
2. Switch the Network Master **OFF**.
3. Place the instrument on its back on a plain surface and turn the lock screw of the battery compartment to match the unlock mark.
4. Remove the lid of the battery compartment.
5. Pull out the battery from the compartment.



6. When installing the battery, note the direction of the battery terminals. With the instrument placed on its back - and the battery compartment in front of you - the terminals should be in the upper left corner.
7. Re-install the battery compartment door and tighten the lock screw.

2.3.2 Charging Battery

The battery automatically charges anytime the instrument is plugged in to a live AC power source using the power adapter. Battery power replenishes more quickly if the instrument is turned off (Standby mode).

Indication during charging

When the power adapter is connected and plugged in, the Power button flashes rapidly in orange while the instrument boots up. After approx. 30 seconds, the button then flashes slowly to indicate the battery is charging. Flashing stops when the charging is complete. If the battery is defective - the Power button will also light. Therefore, the best way to check the battery status is to switch on the Network Master and observe the battery information in the [Instrument information](#) on Instrument toolbar.

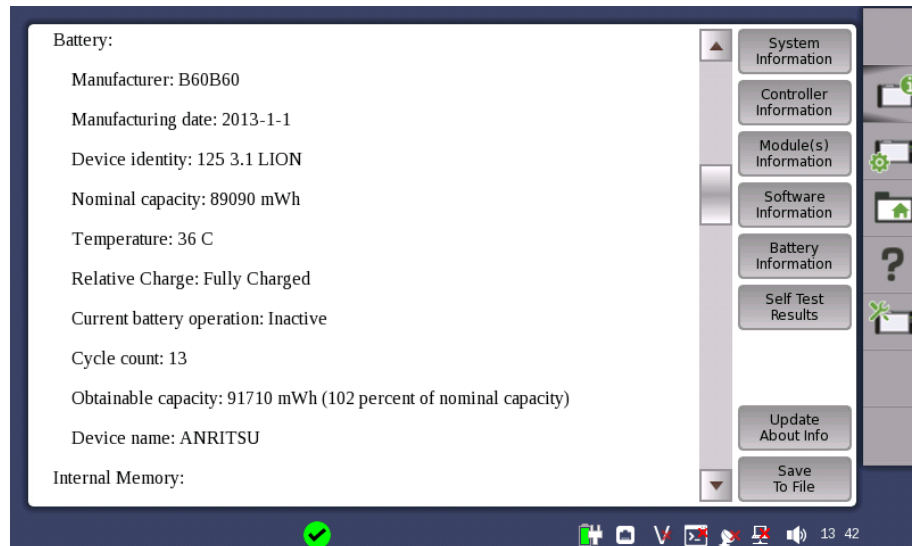

Example of Battery Information

The battery status can be checked in the instrument toolbar (expandable icon toolbar) on the right-hand side of the screen, or in the status line if the battery indicator is displayed there. See the "[Battery Status Information](#)" section below.

2.3.3 Battery Status Information

The battery icon is displayed in the status line at the bottom of the screen.

The following icons are used to indicate the current battery status:



The battery is fully charged. The Network Master is using the AC adapter as power source.



There is no battery in the Network Master (or the battery is malfunctioning). The Network Master is using the AC adapter as power source.



The Network Master is using the battery as power source. The AC adapter is not connected.



Battery charging is not doing because it is out of rechargeable temperature range. The Network Master is using the AC adapter as power source.



There is a delay of several seconds before the battery status is updated.

A more detailed battery status information is launched when touching the battery icon. The example in the figure below shows the status screen of a battery during charging.

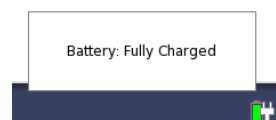

2.4 Measurement Cables

When connecting the Network Master to the line to be tested or monitored, it is recommended always to use shielded cables of good quality, to avoid the possibility of corrupting the measuring results. For the same reason, the AC adapter, if used, should be connected to the instrument and switched on before starting the measurement.

For connection of the Network Master to different types of equipment, different cables are available. Please contact your Anritsu representative for information.

2.4.1 Connecting Measurement Cables

Measurement cables are connected to the input and output connectors located on the connector panel of the instrument. Various electrical and optical connectors are available.

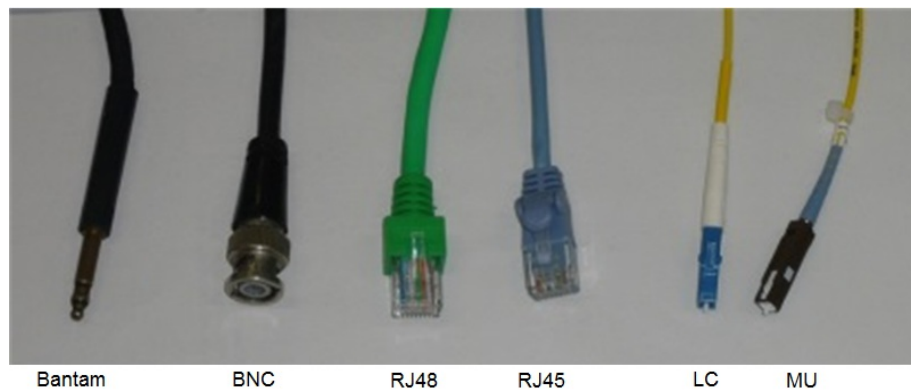

2.5 Support Stand and Carrying Strap

2.5.1 Support Stand

The Network Master is equipped with a support stand keeping the instrument at a convenient angle during the operation. To extract the stand: pull out the metal bar on rear of the instrument - it automatically stays in the correct position.

Be sure to open a support stand fully. Otherwise, the Network Master will be more likely to tip over. Moreover, the air flow on bottom panel will be insufficient.



2.5.2 Carrying Strap and Handle

The included carrying strap and handle can easily be mounted for your convenience when transporting and/or using the Network Master.

The carrying strap is equipped with hooks for easy installation.

WARNING

Use the Carrying Strap around your shoulder. Do not wrap the strap around your neck.



How to attach carrying strap and handle

To attach carrying strap (Z1747A) and handle (Z1748A) to MT1000A Network Master Pro, follow instructions below.

1. Use screw driver and remove the battery lid from MT1000A.



2. Remove the battery pack.



3. Loosen four screws at each corner of MU100010A.



4. Separate MT1000A and MU100010A.
5. Attach the handle on either right or left side.

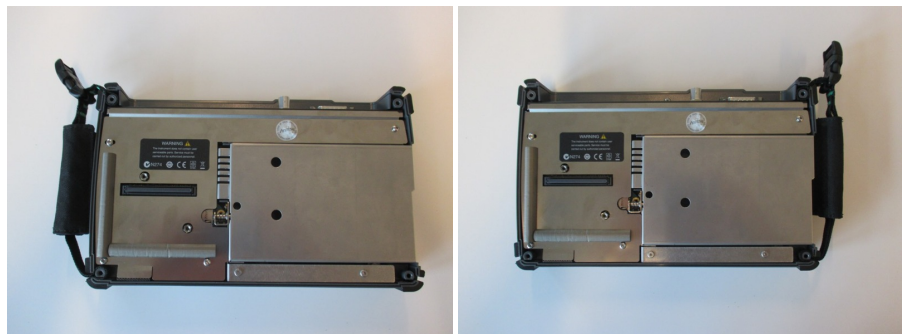

6. Detailed photos for upper and lower corner.

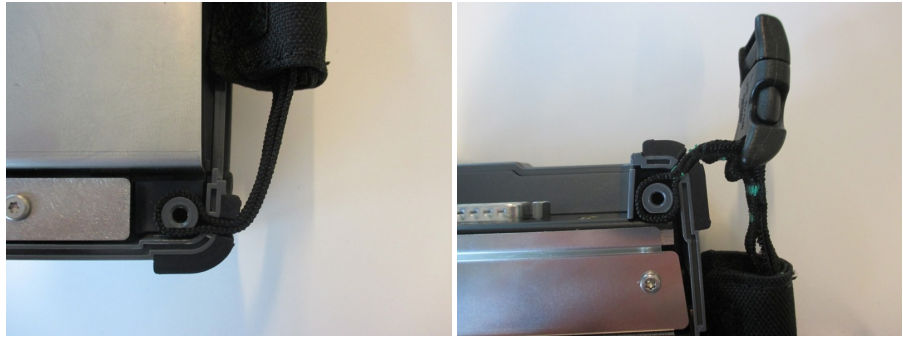

7. Remove the buckle cap from the handle and the carrying strap.

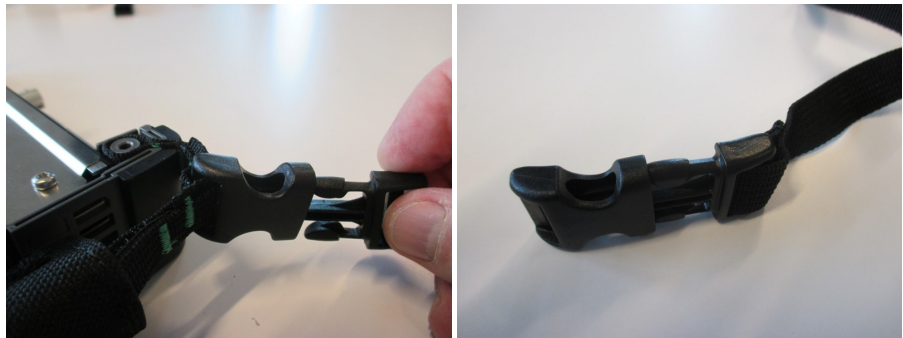

8. Mount the carrying strap on both upper corners.



9. Attach MT1000A and MU100010A , insert the battery pack and mount the battery lid with the reverse sequence at the beginning.



2.6 Modules Configuration

Following modules are available for MT1000A.

Transport Modules

- MU100010A 10G Multirate Module
- MU100011A 100G Multirate Module

OTDR Modules

- MU100020A OTDR Module 1310/1550nm SMF
- MU100021A OTDR Module 1310/1550/850/1300nm SMF/MMF
- MU100022A OTDR Module 1310/1550/1625nm SMF



CPRI RF Module

- MU100040A CPRI RF Module
- MU100040B CPRI RF Module with BBU Emulation Support

GPS Module

- MU100090A High Performance GPS Disciplined Oscillator

MT1000A is able to mount up to three modules. Available module combinations are eleven kinds and shown in the table below. Only one OTDR module can be mounted to the MT1000A.

One module configuration				
	Transport	OTDR*	CPRI RF*	
	MT1000A	MT1000A	MT1000A	
Two modules configuration				
	Transport	Transport	Transport	OTDR*
	OTDR	GPS	CPRI RF	CPRI RF
	MT1000A	MT1000A	MT1000A	MT1000A
Three modules configuration				
	Transport	Transport	Transport	
	OTDR	OTDR	CPRI RF	
	GPS	CPRI RF	OTDR	
	MT1000A	MT1000A	MT1000A	

*: When OTDR module or CPRI RF module is mounted on back, equip with rear panel. B0728A Rear Panel Kit come with different length screws.



Model	Name
B0731A	Screw 3U
B0730A	Screw 2U
B0729A	Screw 1U

2.7 How to Attach the MU100090A

MU100090A is attached to MT1000A with rear panel or MU100010A 10G Multirate module.

CATION

Replacing modules operation should be done on the table where antistatic measures are taken.

Do not drop the modules or give a shock.

Doing so may cause the failure.

2.7.1 Replacing the MU100010A 10G Multirate modules

1. Switch the Network Master OFF.
2. Before the detaching operation, disconnect the AC adapter and remove the battery pack.
3. Place the instrument on its front on a plain surface.
4. Loosen the screws (shown by the yellow circle) on rear side of the MU100010A 10G Multirate module.



5. After loosening the four screws, lift up the 10G Multirate Module with holding both sides. If you cannot lift up, loosen the four screws again. You can see the panel as below.



2.7.2 Attaching the MU100090A and MU100010A

1. Place the instrument on its front on a plain surface.
2. Attach the MU100090A to the MT1000A. Place the MU100090A on the MT1000A so as to connect the following pairs: 1 - 4, 2 - 5, 3 - 6.
Be careful not to bump the guide pins (2, 3, 5 and 6) to the connectors (1 and 4).

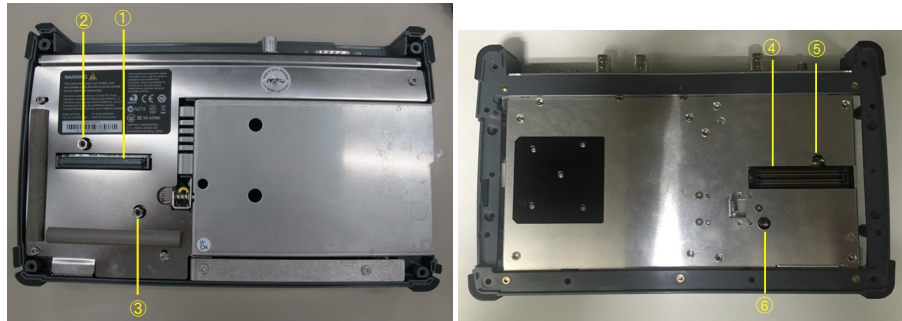

3. Remove four screws of the 10G Multirate module and replace to screws 2U in B0728A Rear Panel Kit.



4. Attach the 10G Multirate module to the MU100090A. Place the 10G Multirate module on the MU100090A so as to connect the following pairs: 7 - 10, 8 - 11, 9 - 12.
Be careful not to bump the guide pins (8, 9, 11 and 12) to the connectors (7 and 10).

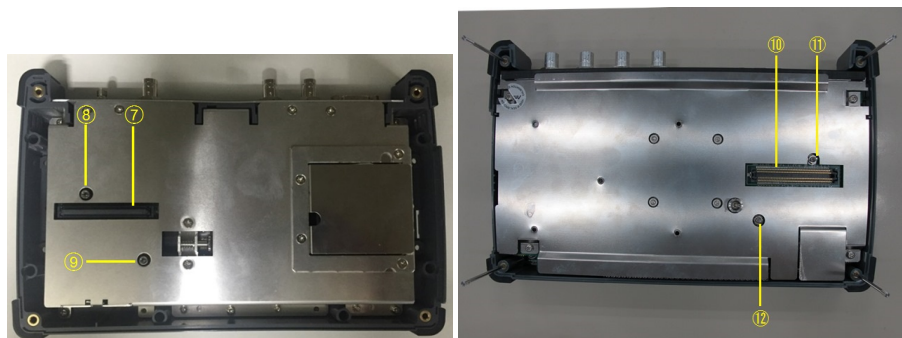



5. Tighten the four screws.



After the module attachment has finished, the external appearance will be as below.



6. Connect the AC cable or install the battery packs.

⚠ CAUTION

When using MU100090A, do not drop the Network Master or give a shock.

Doing so may cause the failure.

May cause a bad effect to the Measurement results.

3 Human-Machine-Interface

Human-Machine-Interface (HMI) covers the relation between the user and the instrument - in other words: the information you get from the instrument combined with the action you add to the instrument.

The informative part is the TFT display, and the part susceptible to influence is the touch-active layer of the screen. Connections made to the input and output connectors are included in the HMI as well.

3.1 Touch Screen Display

The 9 inch active TFT display with WVGA resolution (800x480 pixels) is used for setups and for presentation of results (that is, for all interaction with the instrument). As the display includes touch screen functionality, it is possible to navigate and operate directly from it.

The touch screen display is constructed to be operated by the tip of your finger or by the included *Stylus* (Anritsu part No. Z1746A). The touch screen surface is made of delicate material and is easily scratched or damaged if handled incorrectly.

 **CAUTION**

Never expose the touch screen to excessive pressure as this may damage its functionality.

Never use sharp objects (e.g. pens, paper clips etc.) to operate the touch screen, as this may damage the surface.

Only use a soft cloth moisturized with a mild detergent to clean the surface of the touch screen. Be sure to power off and disconnect main power adapter.







3.2 Key Operation

The only physical operator key (the Power button) is described in this section.

3.2.1 Power Button



The Power button on the front panel of the instrument is used to switch power ON and OFF. In addition, the menu used for power-off also contains a few extra options (e.g. to lock the screen).

-  Gray: Power off
-  Orange flashing (fast): Booting in case of AC operation
-  Green flashing: Booting in case of the battery operation
-  Orange flashing (slow): Charging
-  Orange: Stand by
-  Green: Operating

Switching power ON

AC Operation

Connect the mains power adapter to the Network Master. The Network Master flashes the power button in orange during booting. The power button lights in orange after booting.

To start your test, press the power button. The power button lights in green. After a model name is displayed, the Network Master enters Operating status and shows the Application Selector.

Battery Operation

Press the power button. The Network Master shows a model name and flashes the power button in green during booting.

Then, the Network Master enters Operating status and shows the Application Selector.



In the following cases, the message appears before the Application Selector shows up.

- *Four or more modules are attached.*
- *A MU100011A has been attached to the Network Master without MT1000A-006 option.*
- *Within the four types described in [Module Configuration](#), the same modules type are attached in multiple.*
- *The attached position of GPS module is not appropriate.*
- *The transport module is not attached even if GPS module has been attached.*

Touch OK to shutdown. Turn on after attaching the module(s) properly.

Switching power OFF

When you press the Power button, a pop-up menu containing **Shut Down** will appear.

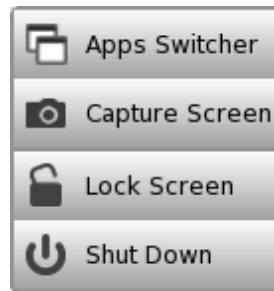

Touch **Shut Down** and then confirm by touching **Yes** in a dialog box.

AC Operation

After you shut the Network Master down, the Network Master goes back to Stand by or Charging state.

The Network Master stays Stand by or Charging state until you disconnect the mains power adapter.

Battery Operation

After you shut the Network Master down, the power goes off.

Forcing power OFF

If it is not possible to power down the Network Master using the power button menu, the following procedure can be used to make an emergency power down.

1. Disconnect AC adapter if it is connected.
2. Hold the Power button depressed for a couple of seconds.



It is not recommended to force a power-off except in emergencies.

Additional options in power button menu

Apps Switcher

Shows all currently activated applications and allows you to switch among them.

Capture Screen

Saves a screen shot image in .PNG format. The image file will be saved in 'Internal/screens' folder or an attached USB memory stick.

Lock Screen

Locks or unlocks the screen.

3.3 Head Set

You can use the commercially available head set (3.5 ϕ CTIA), it is possible to listen speech in the audio channels available in E1 and T1 systems.

CAUTION

Do not operate for a long period of time at high volume level or at a level that is uncomfortable.

The volume is controlled from the [General](#) setup in 'Instrument Toolbar'.

The head set is connected to the socket marked with a head set symbol on the connector panel of the Network Master.



3.4 Connector Panel

All connections (both for *test interfaces* and for *service interfaces*) are placed on the connector panel of the Network Master.

3.4.1 Test Interfaces

MU100010A

The figure below shows the connector panel of the mainframe and MU100010A.

The connector panel contains the following port connectors to be used for the tests:

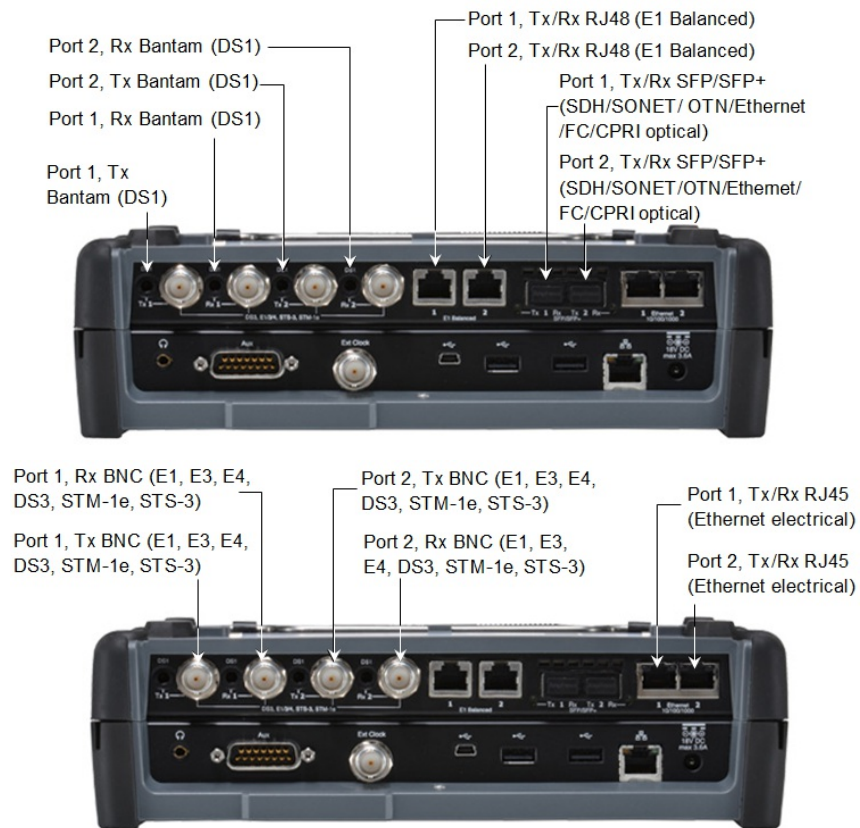

MU100011A

The figure below shows the connector panel of the mainframe and MU100011A.

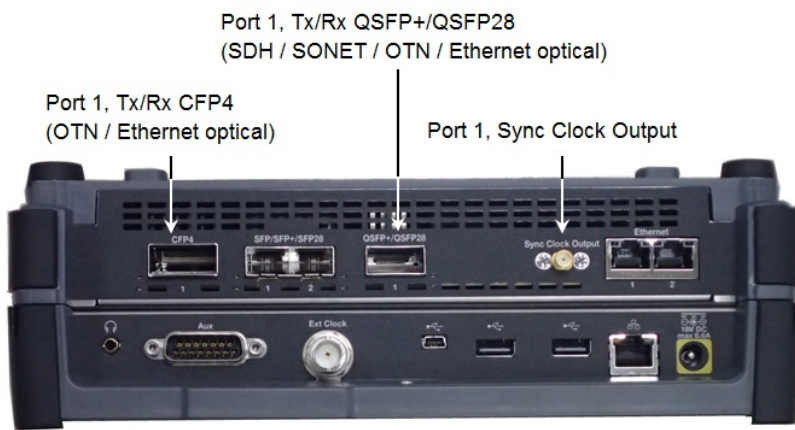
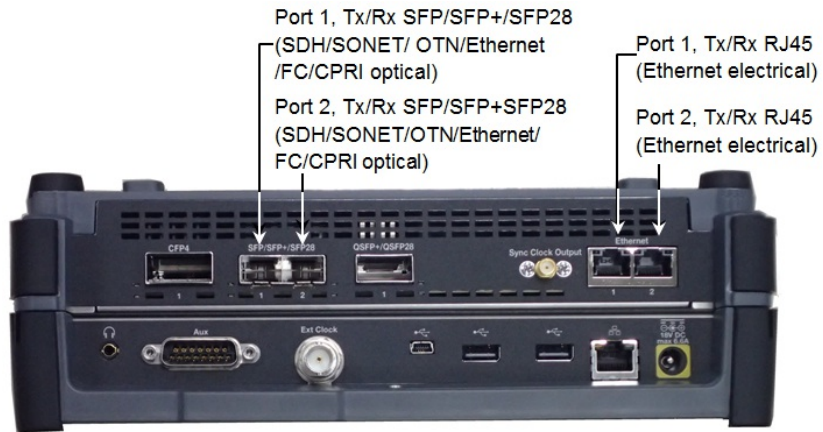

3.4.2 Service Interfaces

All connections concerning the service interfaces are also located on the connector panel:

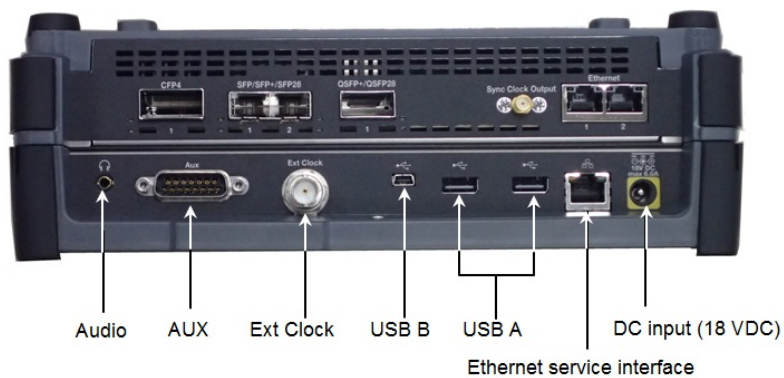

Audio	The audio connector is used for connecting to an optional head set.
AUX	The AUX connector is used for optional G0325A GPS Receiver.
Ext Clock Input	The Ext Clock Input connector is used for reference clock input.
USB B	The three USB connectors (two connectors type A and one connector type B mini) can, for example, be used for connection with USB memory stick. This is convenient for the exchanging of information to other instrument.
USB A	
Ethernet service interface	The Ethernet connector is used for connecting the Network Master to a Local Area Network, e.g. to remotely operate the instrument from a PC.
DC input (18 VDC)	The DC power connector is used for connection of 18 V DC power delivered from the AC Adapter. For option 006, a yellow marking is printed around the connector.



Network Master supports only USB memory sticks formatted in FAT32.

3.4.3 GPS Disciplined Oscillator Interfaces

All connections concerning the GPS Disciplined Oscillator interfaces are also located on the connector panel:

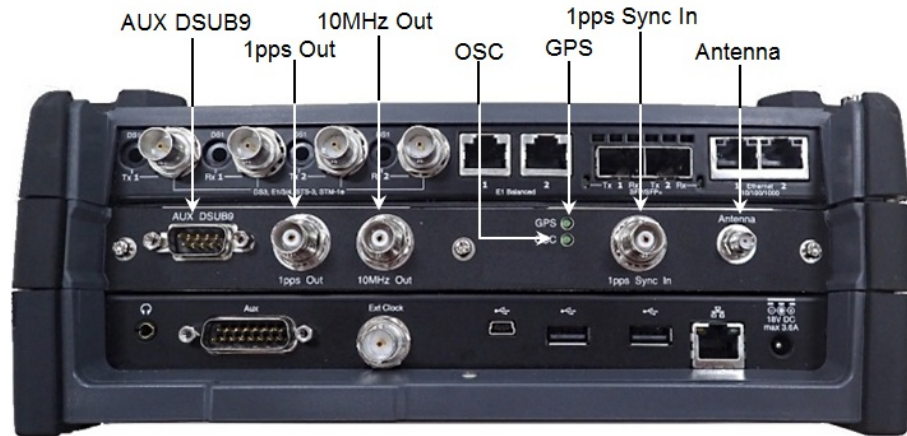

AUX DSUB9	Connects to AUX connector on MT1000A panel using J1705A AUX Conversion Adaptor.
1pps Out	The 1PPS signal is output. *
10MHz Out	The 10 MHz clock signal is output. *
GPS	Lights in green when signals of four or more satellites are being received.
OSC	Lights in green when the Rubidium oscillator stability reaches 10^{-9} . This lights within around ten minutes usually. However this varies depending on ambient temperature.
1pps Sync In	The input connector of the external 1PPS reference signal for the synchronization.
Antenna	The connector for GPS antenna.

*: Signal which is synchronized with GPS or the signal inputted to 1pps Sync In.

Connections of GPS Disciplined Oscillator Interfaces

Connections of GPS Disciplined Oscillator Interfaces are shown below. Use GPS antenna, BNC cables and J1705A AUX Conversion Adaptor for the connections.

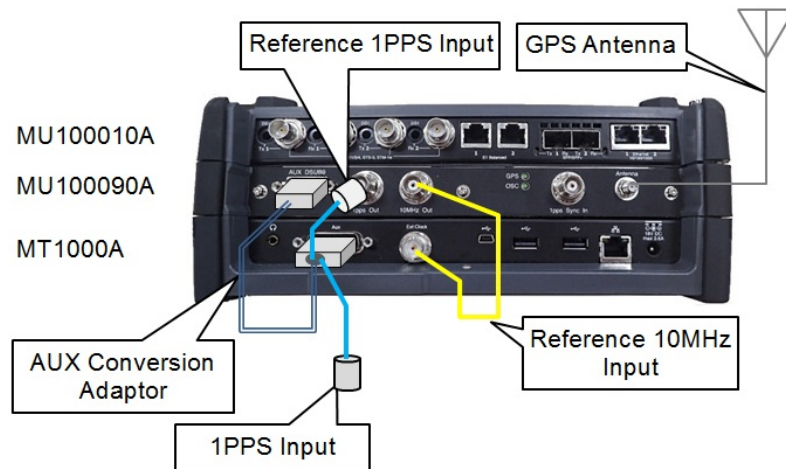

1. Connect J1706A GPS antenna to Antenna connector on the MU100090A. Commercially available GPS antenna can be used.
2. Connect AUX DSUB9 of the MU100090A to AUX of the MT1000A using J1705A AUX Conversion Adaptor.
3. Connect 10MHz Out of the MU100090A to Sync In of the MT1000A using J1710A BNC Cable.
4. Connect 1PPS Out of the MU100090A to REF 1PPS IN of J1705A AUX Conversion Adaptor.
5. Input the signal under measurement to 1PPS IN of J1705A AUX Conversion Adaptor.



When performing the measurements using GPS time by capturing GPS satellites, wait 30 minutes or more for the synchronization after capturing GPS satellites. If waiting time for synchronization is short, the correct time will not be obtained.

When feeding the power to a GPS antenna using external power supply, insert a bias tee between the GPS antenna and MU100090A.

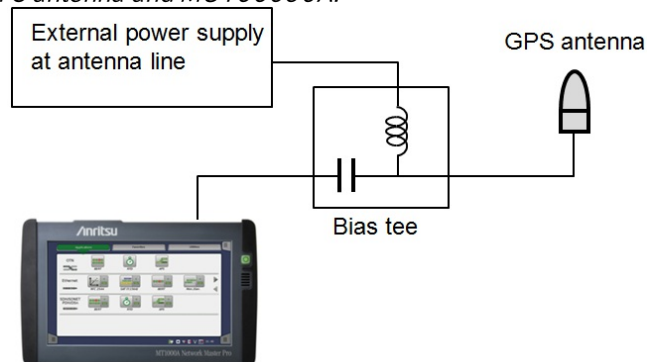

Select a bias tee which meets the MU100090A specifications below:

- Antenna connector: SMA, Jack (refer to 12.4.2 "Electrical performance and function")
- Supported signal: GPS L1 C/A Code (refer to 12.4.3 "GPS Synchronization")

3.5 Remote Operation

With the MX100001A MT1000A/MT1100A Control Software (hereafter, "Control Software") application installed, your PC is capable of supporting remote access to the Network Master. Control Software simulates the panel operation of the Network Master, allowing you to operate and view results on a PC through a LAN or Internet connection. If more Network Masters are linked to a network, they can be remotely controlled by the same PC, one at a time.

3.5.1 Installation of Control Software

Operation Environment

OS	Windows 7/8.1 English/Japanese
Interface	Ethernet 100BASE-TX/1000BASE-T
Display	800 × 600 dots or more

1. Copy the installer stored in the Network Master to your PC, by USB memory stick or the file sharing function.
File Name: MX100001A-Setup-x.xx-xxxxx.exe
"x"s in the file name mean numerics showing the version.
2. Double click the installer file.

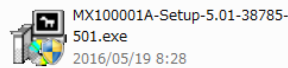

3. If User Account Control dialog box appears, click **Yes**.
4. After the installation finishes, click **Close**.

Click **Start** > All Programs > Anritsu > MX100001A folder. Confirm that following programs appear. "V*.*" is replaced to the version name.

- MX100001A-V*.*-Editor
- MX100001A-V*.*-Remote
- MX100001A-V*.*-Viewer
- V*.*-Uninstall



When installing a new version of the Control Software, previous versions are not automatically uninstalled. To manually uninstall a Control Software version, execute "Uninstall" from the Control Software folder from the Start menu of Windows.

3.5.2 Connection and Setup

To make Remote Operation application communicate with Network Master:

1. Connect an Ethernet network cable to the LAN connector on your Network Master and link this to a Local Area Network.
2. Assign an IP address to the Network Master. This is done in the *Ethernet* setting available from the [Network](#) screen as described in the *Graphical User Interface* chapter.
3. Enable **Allow remote PC** in the [Remote Control](#).
4. Display the [Resource Monitor](#). Confirm that the IP address and "running Tests and Views" appear.

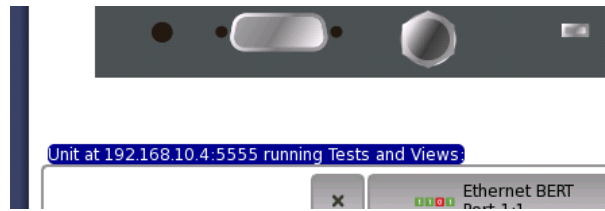

- Change the Network settings of the PC, so it can access the Network Master via Ethernet.
 Select Control Panel -> Network and Internet -> Network Connection.
 Right-click the interface and click the Properties.
 Select the properties of Internet Protocol Version 4 (TCP/IPv4) and click the Properties button.

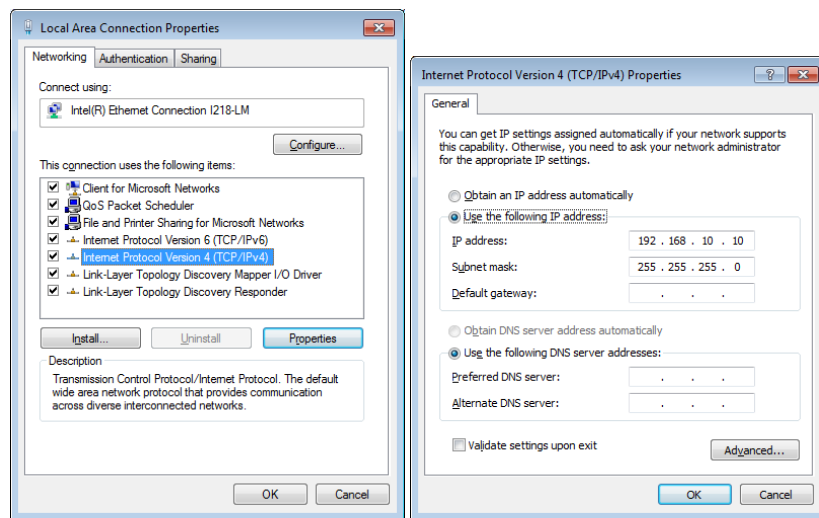

- Execute Ping command on PC to confirm connection to the Network Master.

3.5.3 Communication Ports

When using the MX100001A Control Software with a Network Master connected behind a port restrictive firewall, to successfully communicate with the instrument, it is important to configure the firewall to allow communication on the following ports:

5555	Framework core communication port, fixed. Used by Control Software main GUI, including the Remote Upgrade function.
5650 to 5699	Application servers, fixed range. Used by Control Software Application GUIs.
5898	Unit reset port, fixed. Used by Control Software Remote Reset function.
58012	Remote wake-up port, fixed. Used by Control Software Remote Wake Up function.

In addition, the following ports are used for other network functions in the Network Master:

56001 (default)	SCPI server port, user configurable. Used by remote SCPI clients. Refer to Remote Control section for details how to setup.
5900 (default)	VNC (TCP), user configurable. Used by remote VNC clients.
5800 (default)	VNC over HTTP, user configurable. Used by remote VNC over HTTP tunnel clients. Refer to VNC section for details how to setup VNC communication ports.
135, 137, 138, 139, 445	File Sharing, fixed ports.

3.5.4 Starting Control Software

1. Open Anritsu-MX100001A folder from Start menu.
2. Click **MX100001A-V**-Remote**.

If Windows Security Alert appeared, click **Allow access**.



Before connecting to the Network Master, confirm that the response from the Network Master is quick enough. If the response from Network Master via the Ethernet network is too late, a connection fails and the message "Network connection is too slow!" appears.

Executing Remote Operation on control PC:

1. If Control Software launched, the initial screen for remote operation appears as below.

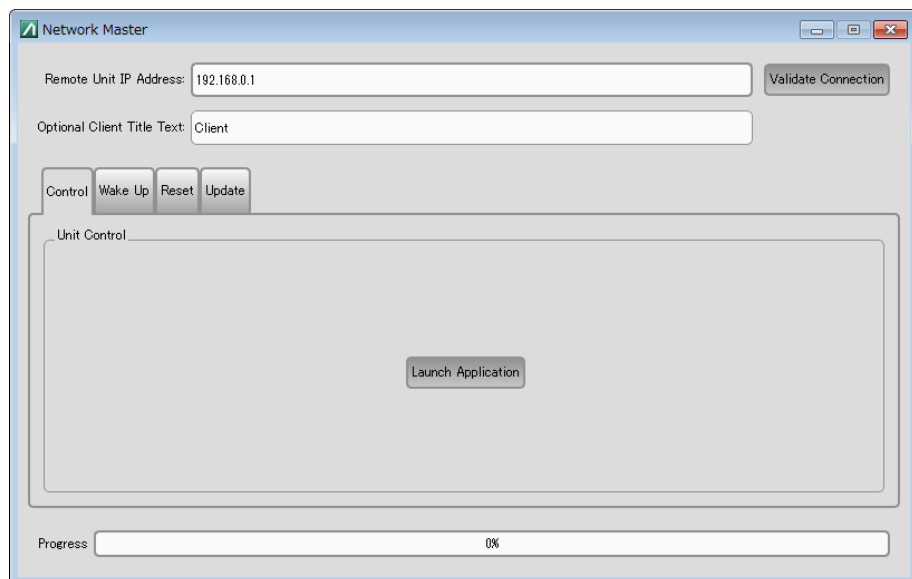

When two or more network interface cards are available, **Use Network Interface** selection appear. Touch the field to select a interface.

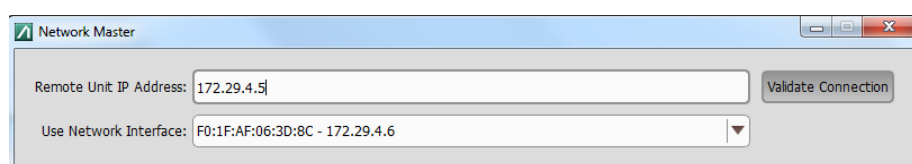

2. Enter the IP address of the Network Master to **Remote Unit IP Address**.

3. In **Optional client Title Text**, enter the name of the Network Master. This text is displayed at the title bar of the Control Software and on the button in the [resource monitoring](#) screen.

For example, when you enter 'Anritsu', you will see 'Anritsu' on the button in the resource monitoring screen as shown in the figure below.

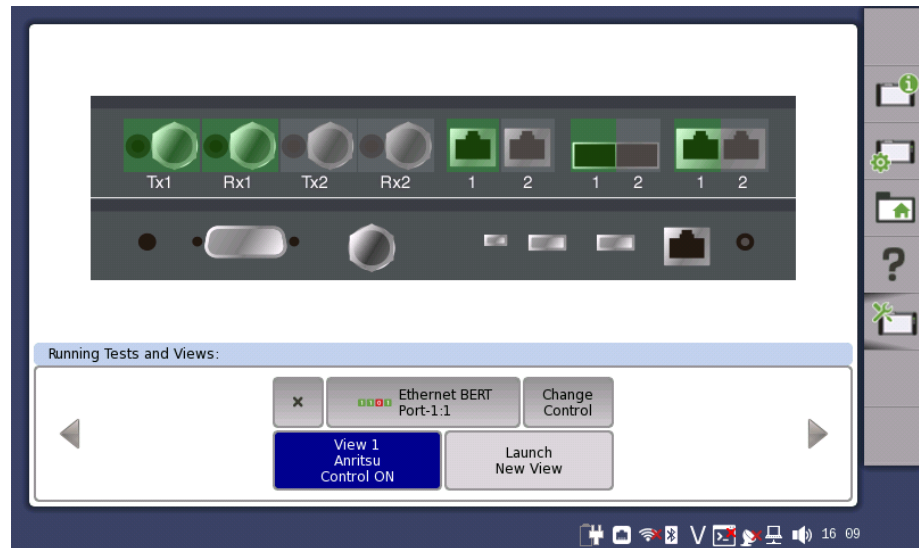

4. Click **Validate Connection**.
5. Clicking **Launch Application** in **Control** tab will display the Network Master screen.

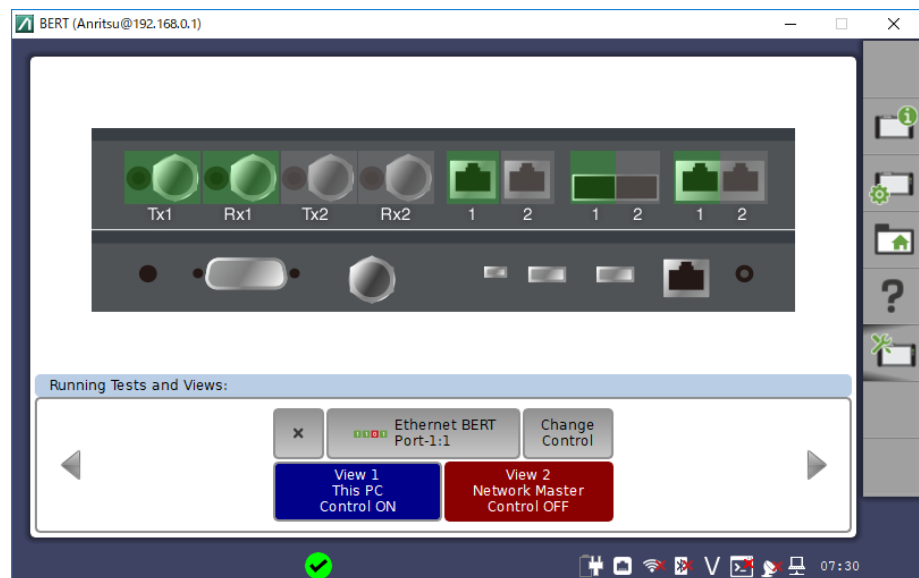

When **Optional client Title Text** is blank or set to the following text, the IP address of the control PC appears in Resource monitoring of the Network Master.

- Client
- ClientName
- Local
- This PC

To exit Control Software, click Close button at right hand top of the window. Power button menu appears, and click **Close**.

3.5.5 Remote Upgrade

If the MX100001A Control Software version differs from that of Network Master, when clicking **Launch Application**, the software upgrading dialog appears. Upgrade Network Master Software to the version compatible with MX100001A Control Software.

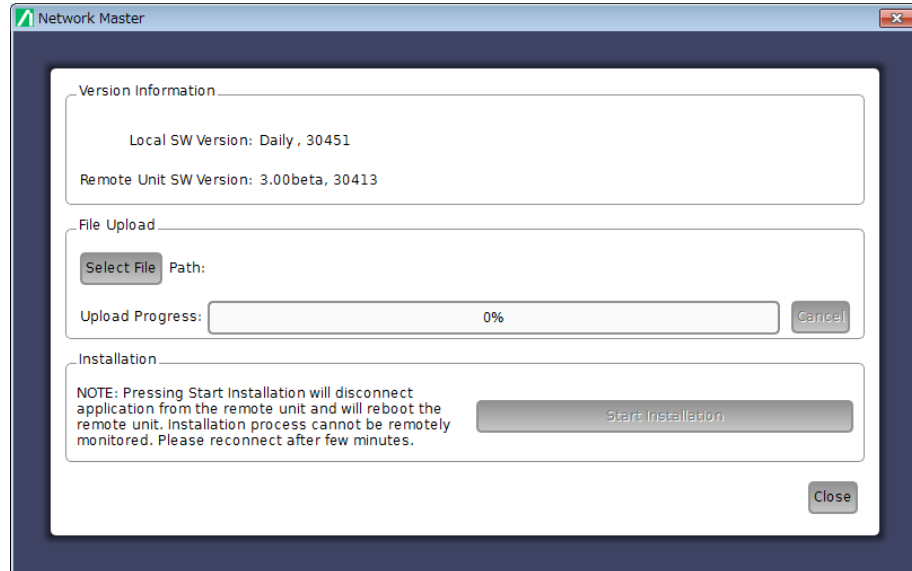

The MT1000A software including the MU100011A is updated as needed, and the latest version of software is published on our website. Visit our website and download the latest version. We have two types of installers as below.

- MT1000A_Software with MU100011A
- MT1000A_Software



*"MT1000A_Software with MU100011A" is consisted from two files. Select both files when upgrading the software.
Note that installing "MT1000A_Software" is not able to work the MU100011A.*

1. Click **Select File** to launch the dialog box.
2. Select the software file. When you select the folder where you unpacked the installer, the installer file will be selected automatically. Multiple files can be selected by selecting a file while holding down the **Ctrl** key.
3. Progress bar shows Upload Progress. Clicking **Cancel** aborts the file uploading.
4. After file uploading finishes, click **Start Installation**.



*Clicking **Start Installation** will reboot the Network Master. Installation process cannot be remotely monitored. Please reconnect after a few minutes.*

3.5.6 Remote Power Control

Power On

If Network Master is in Stand-by mode, it is possible to remotely get the unit into the Operation state.

1. Click **Start** > All Programs > Anritsu > MX100001A folder.

2. Click **MX100001A-V**-Remote**.
3. On the Control Software startup screen, enter the IP address of the Network Master in the **Remote Unit IP Address** field.
4. Click **Start** in **Wake Up** tab.
5. After the progress bar reaches 100%, click **OK** in the dialog box.

Power Off

If the **Allow remote PC shutdown** check box is selected in the [Change Remote Control Options](#) dialog box, you can remotely set Network Master in Stand-by mode.

1. In the upper-right corner of the MX100001A window, click the Close button.

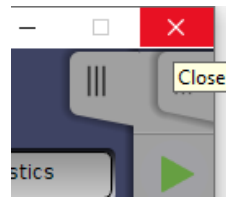

2. Click **Shut Down**.

3.5.7 Remote Reset

The Remote Reset function can be helpful if the unit is on a remote site and unexpectedly freezes or becomes unresponsive. The possibility to remotely reset an instrument can be disabled by unchecking the **Enable Remote Reset** check box in the [Remote Control](#) options.

To remotely force a reboot the Network Master, specify the Network Master using its serial number.

1. On the Control Software startup screen, enter the IP address of the Network Master in the **Remote Unit IP Address** field.
2. Enter the serial number in the **Controller SN** field on the **Reset** tab.
3. Click **Start** on the **Reset** tab.
4. After the progress bar reaches 100%, click **OK** in the dialog box.



Make sure to save measurements and settings before initiating Remote Reset function. The Reset will force the Network Master to reboot. All unsaved or ongoing measurements will be lost.

3.5.8 Stand-alone Editor

MX100001A Editor allows users to load, edit, and save Setup files of any possible Network Master configuration, without connecting to an actual instrument.

1. Click **Start** > All Programs > Anritsu > MX100001A folder.
2. Click **MX100001A-V**-Editor**.

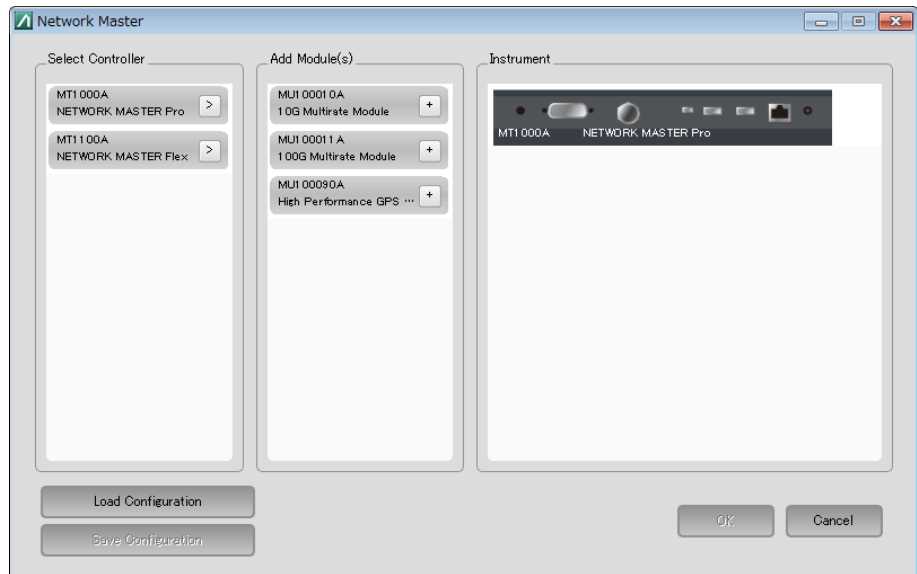

3. Set configuration of Network Master by clicking options in **Select Controller**, and **Add Module(s)**.
To save the configuration, click **Save Configuration**.
4. Click **OK**. After a while, the GUI of the selected Network Master configuration appears.
5. Select an application, select port resources, and configure settings and measurement parameters.
6. Once done, save the setup file by clicking **Load/Save** on [Application Toolbar](#).

Load the Setup File saved by the MX100001A Editor on the Network Master by clicking **Load/Save** button on the [Application Toolbar](#). Alternatively, import the settings file as a Favorite, and launch the new application from the [Favorites](#) screen on the **Application Selector**.

3.6 Command-Based Remote Control

Using command-based scripts makes the Network Master a fully automated measurement instrument.

- The Network Master remote control communication functions support the built-in Ethernet service interface.
- Software specifications are in conformity with the IEEE488.2 standard and SCPI version 1999 (Standard Commands for Programmable Instruments).

All commands are described in a separate document:

- MT1000A Network Master Pro MT1100A Network Master Flex Remote Scripting Operation Manual (M-W3736AE).



This icon on Status bar indicates whether the Network Master is controlled by the command-based scripts or not. If touching this icon, buttons appear.

Touching the **Turn Off** button will disconnect the SCPI connection. Use this button if disconnecting the Ethernet cable.

Touching the **Enable Local Control** button will allow the panel operation with keeping SCPI connection. This function is useful for debugging the control software.

3.7 In-band Control

In-band Control remotely controls Network Master via a port. This control method is available when Ethernet application is running in the Network Master. This allows users to control Network Masters via a device under test or a network under test, etc.

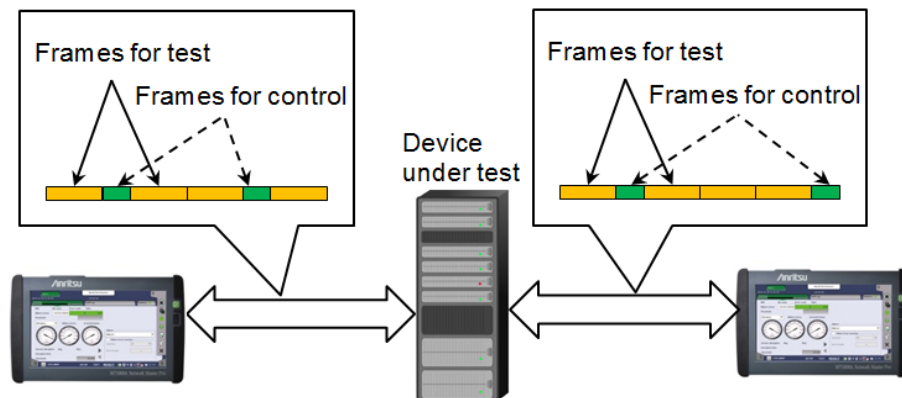

1. Start Ethernet application except Pass Through and Cable Test without the OTN layer in Network Master.
2. Set **Nickname** and **In-band TCP port** in [Remote Control](#).
3. Select **Allow In-band control** in [In-band Setup](#), and set an IP address, etc.
4. Start the Discovery application in Network Master used as a controller.
5. Search for other Network Masters using the Discovery application, and control them.



In-band Control only switches the application of Network Master.

3.8 File Access via USB Interface

You can access the mass storage of the Network Master by connecting the USB cable.

This function is useful to copy the files to PC, or confirm the test results.

1. Close all applications by touching **Close** icon on the Application Tool Bar.
2. Connect the USB cable between PC and USB type B connector of the Service Interface.
3. If PC has detected the Network Master, copy files or folders to PC using PC software (Explorer of Windows etc.).

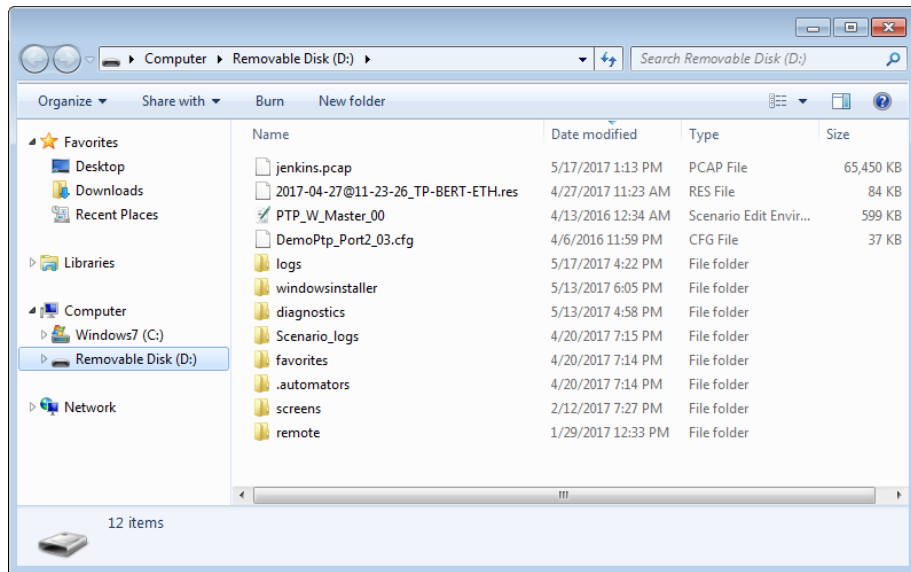

If applications are running on the Network Master, you cannot access the mass storage.

3.9 File Access via Ethernet Interface

3.9.1 Accessing files in Network Master from the PC

The mass storage of the Network Master can be shared with your PC via Ethernet interface.

1. Connect an Ethernet network cable to the LAN connector on your Network Master and link this to a Local Area Network.
2. Assign an IP address to the Network Master. This is done in the *Ethernet* available in the [Network](#) screen as described in the *Graphical User Interface* chapter.
3. Select **Share File System** in the [File Sharing](#) settings.
4. Start *Explorer* on your PC.
5. Enter the IP address of Network Master into the address bar.
For example, enter like \\192.168.10.4\ . The shared folder appears.

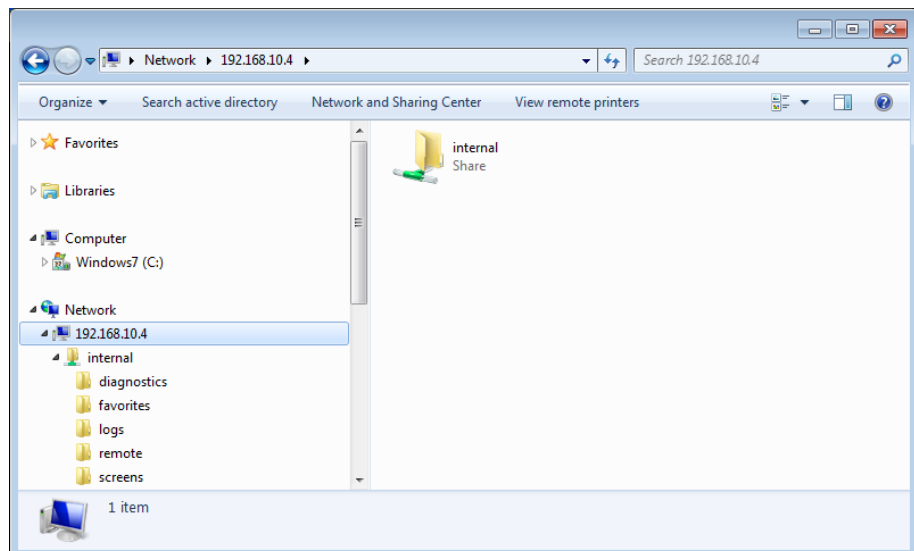

If applications are running on the Network Master, you cannot access the mass storage. The folders and files in the mass storage are set to read-only.

3.9.2 Mounting the Shared Folder of Networked PC to the Network Master

Network Master can mount the shared folder of the networked PC. The following procedure is explained, assuming "test" folder is created on the PC.

1. Create the folder in the PC.
2. Right-click on the folder and click **Properties**.
3. Click the Sharing tab, and click **Share** to set shared.

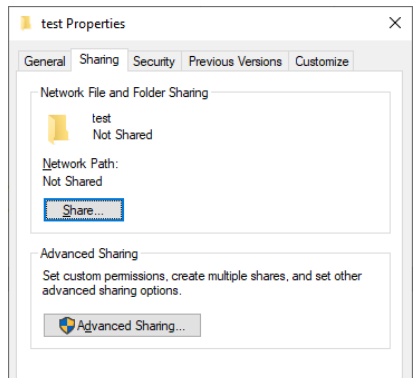

- 4. On the Windows Start menu, click **Control Panel**.
- 5. Click **System** and write down the domain name.

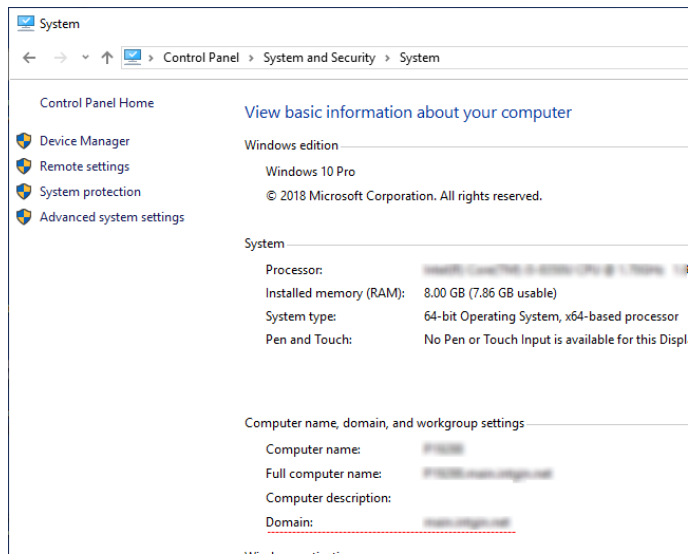

- 6. Click **Control Panel Home** and click **Network and Sharing Center**.
- 7. Click **Change adapter settings**.
- 8. Click the network icon and click **View status of this connection**.
- 9. In Status dialog box, click **Details**.
- 10. Record IPv4 address.

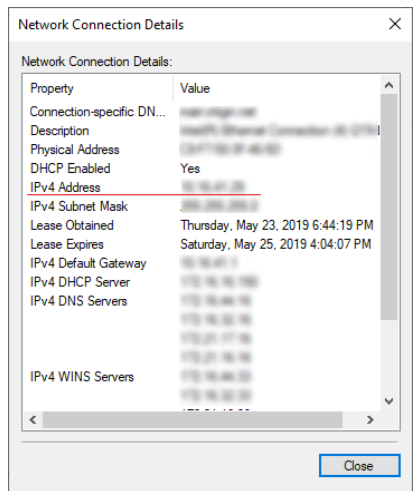

- 11. Connect an Ethernet network cable to the LAN connector on your Network Master and link this to a Local Area Network.

12. Assign an IP address to the Network Master. This is done in the **Ethernet** available in the [Network](#) screen as described in the *Graphical User Interface* chapter.
13. Select **Mount Remote Folder** in the [File Sharing](#) settings.
14. Enter the IP address (step 10), domain (step 5), user name, folder name and other information.
 Note that enter User name of User Account of the PC.

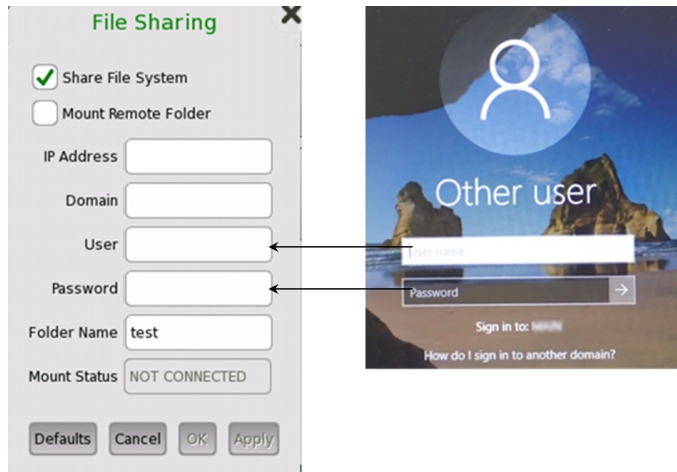

15. Touch **Apply**. If the remote folder has mounted successfully, you will see "CONNECTED" is shown at Mount Status. Touch **OK** to close dialog box.
16. On Instruments Toolbar, touch File Manager (🏠) icon. Now, you can see the shared folder is mounted to Internal\remote.

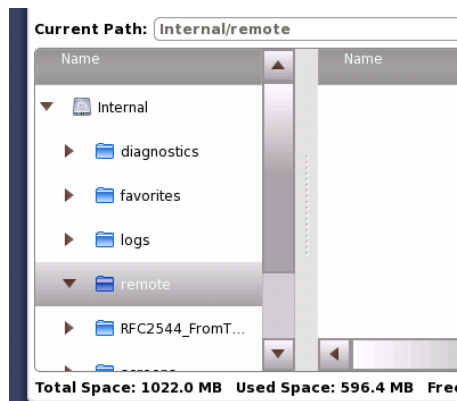

3.10 GPS Receiver

3.10.1 G0325A GPS Receiver

G0325A GPS Receiver contains GPS antenna and GPS receiver and is used by connecting to AUX connector of Network Master. The synchronization accuracy against UTC is $\pm 1 \mu s$ or less.

The GPS receiver is used for:

- Precise time synchronization, when making one way Frame Transfer Delay measurements as part of the Ethernet Service Activation Test.
- Clock source in an IEEE 1588v2 system
- Timing source for synchronizing Ethernet transmitters



Activating the GPS receiver

The GPS receiver is activated automatically if it has connected to Network Master.

Using the GPS service

One purpose of the external GPS receiver is to provide for precise one way Frame Transfer Delay measurements as part of the Ethernet Service Activation Test.

When the GPS receiver is activated and the active interface is Ethernet, the Network Master will calibrate its internal time base to the ultra precise time signal from the GPS receiver. The calibration process takes approximately 1 minute.



To perform [Sync Test](#) of Ethernet application, use the MU100090A. Installing the MT1000A-005 AUX I/O, GPS antenna, J1705A AUX conversion Adaptor and J1710A BNC Cable 0.2m are also necessary.

3.10.2 MU100090A GPS Disciplined Oscillator

The MU100090A needs to connect GPS antenna and and to be connected to the MT1000A using J1705A AUX conversion Adaptor and J1710A BNC cable 0.2m. MT1000A-005 AUX I/O is also needed.

Activating the GPS receiver

Touch the GPS icon, and setting MU100090A Power to **On** will activate the GPS receiver.

To realize ± 45 ns rms accuracy against UTC, all the following conditions should be met.

- Warm up three hours or more after turning the MU100090A power on.
- Synchronize Rubidium oscillator by capturing GPS satellites for 30 minutes or more or by inputting the signal to 1pps Sync In connector for 30 minutes or more.
- Keep ambient temperature constant.
- Avoid vibration and shock.



After removing the GPS antenna, keep the surrounding temperature as constant as possible and avoid vibration and shock.

3.10.3 Operating GPS Receiver

GPS Icon

An icon in the status bar will indicate the current GPS status. One of the following icons will be shown:



The GPS is receiving signal from a sufficient number of satellites.



GPS receiver is not connected.

Touching the icon will display an information pop-up dialog box.

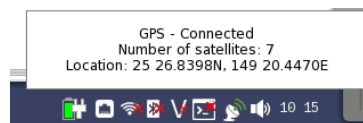

The pop-up dialog box shows the current GPS status, and, for purely informational purposes, the number of satellites used for position fix, and the current geolocation of the GPS receiver, in degrees and decimal minutes format.

When the MU100090A is installed, the following buttons appear in the pop-up dialog box.

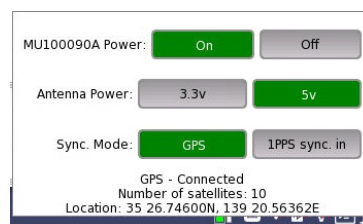

- **MU100090A Power:** Touch the button to turn on the MU100090A power or turn off.
- **Antenna Power:** Touch the button to set the feeding power voltage to the antenna.
J1702A GPS Antenna accepts both voltages.
- **Sync Mode:** Touch the button to select the signal to use to the built-in Rubidium Oscillator synchronization.
Refer to [MU100090A Block Diagram](#).

3.11 Remote Control via GPIB

Using a J1667A GPIB-USB Converter, an optional accessory, allows users to control Network Master via GPIB. GPIB address of Network Master can be set in the [Remote Control](#).

[Command-Based Remote Control](#) is available via GPIB control. MX100001A MT1000A/MT1100A Control Software does not support operation via GPIB.

4 Graphical User Interface

This chapter provides a general introduction to the graphical user interface (GUI). The descriptions of the screens, sub-screens and major dialog boxes related to specific technologies and applications are placed in separate chapters.

4.1 General Handling of the GUI

The Network Master is equipped with a touch screen display, except for the key to switch the instrument on/off. The operating principle of the graphical user interface (GUI) presented on the touch screen display is that it guides you through all setup steps required for running a specific test and then finally presents you with the test results. You can also navigate back and forth between setup steps and result presentation to re-run a test with new parameter settings if required.

4.1.1 GUI Concept

The GUI can be split up into two functional spaces or levels: the *desktop* and the *workspace*.

- The *desktop* is the entry level which appears after the booting. It consists of the *application selector*, which allows you to start a new application, and the *result file browser*, which allows you to access previously created and stored test results.
- The *workspace* is where you work with a specific application (i.e. set up and run a test and inspect the test results). Your selection on the desktop creates the workspace and loads relevant data into it.

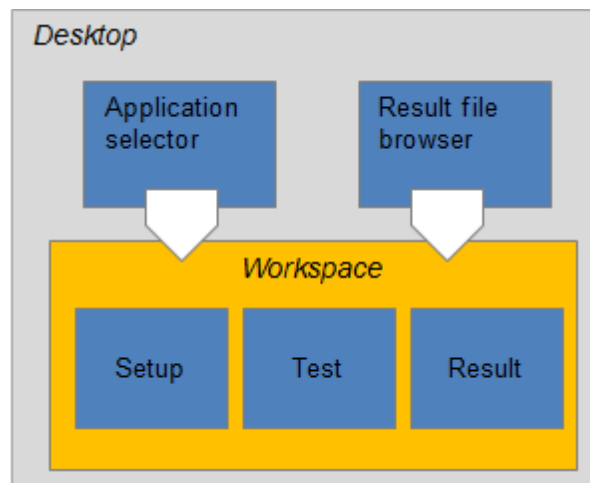

Application selector

The *application selector* loads a new application into the workspace. A new application can be either one of the standard applications provided with the instrument or a previously saved application with partial or full configuration of interface/test setup parameters.

Result file browser

The *result file browser* loads the results and configuration of a previous test into the workspace. This allows you to generate reports from the results and/or to rerun the test (either using the original configuration or with various configuration modifications).



A specific set of resources (i.e. ports) are assigned to a workspace when it is created. More than one workspace can therefore exist at the same time, each assigned to different resources.

4.1.2 Navigating in the GUI

As shown in the previous figure, you can navigate from the application selector to a specific application in the *workspace* vertically. You can navigate between the application selector and the result file browser in the *desktop* horizontally. In this way, you can switch screens in both horizontal and vertical navigation.

Horizontal navigation at desktop level

You can switch between the application selector and the result file browser by touching the tab displayed in the bottom right-hand corner and the bottom left-hand corner.

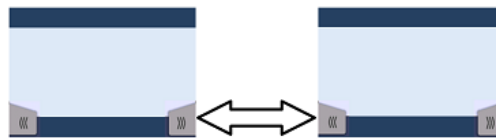

Horizontal navigation within a workspace

In the workspace you can step through the setup by touching the navigation tabs displayed in the bottom corners of the screen. The right-hand tab brings you to the next step in the setup, while the left-hand tab allows you to take a step backwards.

Alternatively, you can use the *screen indicator* at the bottom of the screen to switch between ports setup, test setup and test result.

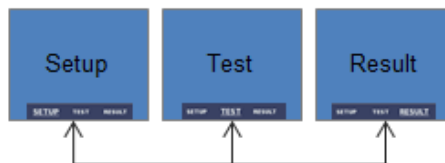

It is also possible to loop back directly to the ports setup from the test result screen if you need to rerun the test with different settings.



To get from the Test Setup to the Test Result screen during a new test, you must run the test. This is done by touching the 'Start' icon in the Application toolbar, which is the expandable toolbar shown on the right-hand side of the screen. Please refer to the separate [Toolbars](#) section for information about the toolbars.

Vertical navigation between desktop and workspace

When an application is currently running, the application selector screen will contain a tab at the bottom which allows you to go directly to the screen last displayed in the application's workspace. Similarly, the result file browser screen will contain a tab at the bottom which brings you to the test result screen of the running application.

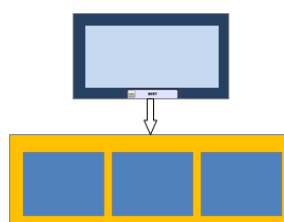

From a setup screen you can return to the application selector using the tab at the top of the screen. Test result screens contain a tab at the top which returns you to the result file browser.

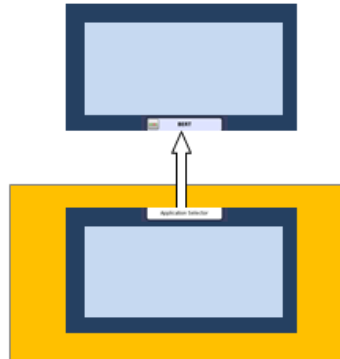

4.1.3 Layout of the GUI Screens



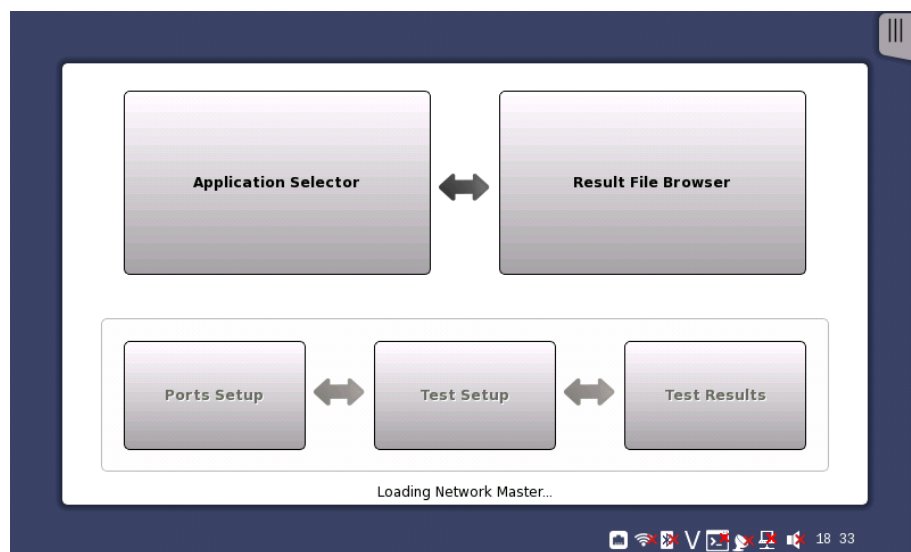





Startup Splash Screen The Network Master starts up with a splash screen that shows the GUI concept of desktop/workspace and the various screen types. It indicates both *application selector* and *result file browser* as entry points.



Status icons

There are status icons of the battery and the network connections at bottom of the screen. This blue area at bottom of screen is the "status bar".

When the network connection is unusable, the red cross (✖) appears on the icon.

-  Battery status
Refer to "[Battery Status Information](#)".
-  Link status of Ethernet service interface
-  WLAN (when the option is installed.)
-  Bluetooth (when the option is installed.)
-  VNC (Virtual Network Computing)
-  Controlled by the remote command
-  Connection status of GPS receiver
-  External PC status
-  Speaker On/Off status

4.1.3.1 Starting the Application

Application Selector The **Application Selector** screen is the main entry point after startup of the Network Master. From here you can choose which application/test to run: either one of the standard applications or a previously saved pre-configured application.

Applications

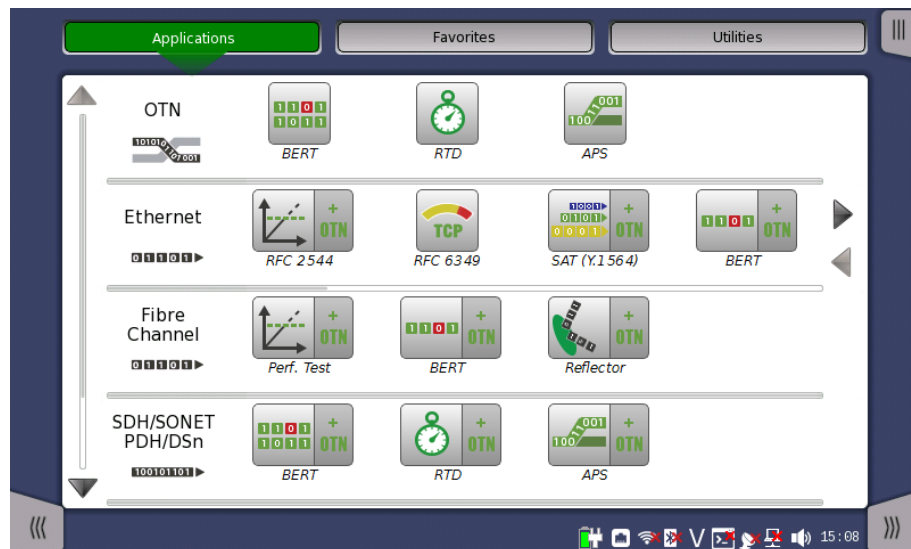

The icon you need may not be displayed because icons on screen are limited to four. You may need to scroll the row of applications to display the relevant icon.



Touching + OTN adds OTN layer for SDH/SONET Ethernet or Fibre Channel applications.

Aside from the application buttons, the application selector screen also contains a tab for showing/hiding the [Instrument toolbar](#) and a navigation tab to the [Result File Browser screen](#).

Favorites

A Favorite application is basically an application with an associated set of port resources and specific settings. When launching a Favorite application, the associated port resources are automatically allocated and the associated settings are subsequently loaded.

Favorites require a specific number of resources to run corresponding to the number of resources used when the Favorite was first created. If the resources of the Favorite are not available, user is prompted to select alternative port(s).

Touching **Favorites** button displays the screen below.

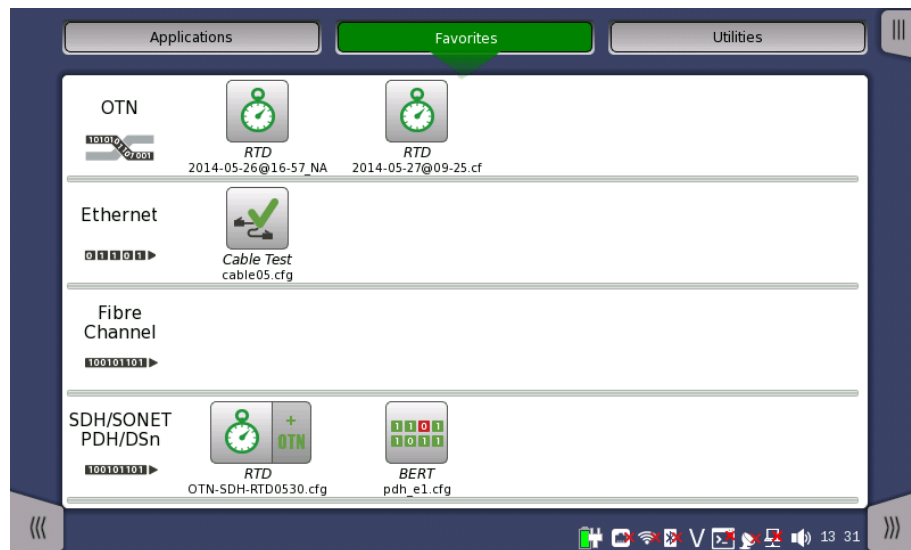

Creating favorites

1. Go to the workspace of the application you want to save as favorite.
 - o Touch the **Applications** button and touch an icon to be registered.
 - o Return to the workspace by touching the button at bottom.
2. Touch the Application toolbar tab.
3. Touch the **Load Save** icon.
4. Touch the **File name** field.
5. Enter the file name using the dialog box.
6. Select **Add to Favorites** in the Save/Load dialog box.

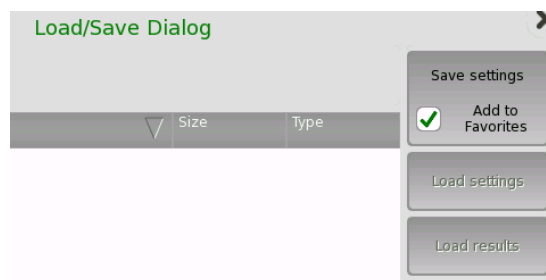

7. Touch the **Save settings** button.

On the Favorites screen a new favorite is now created containing the current application resources and settings.

Deleting favorites

1. Touch and hold an icon in Favorites screen until a pop-up menu appears.
2. Touch **Delete Favorite**.
3. Touch **Delete** if the confirmation dialog box appears.

Renaming favorites

1. Touch and hold an icon in Favorites screen until a pop-up menu appears.
2. Touch **Rename Favorite**.
3. Input a new name on the opening dialog box.

Importing favorites

Settings files (.cfg) can be registered to Favorites by using the [File Manager](#).

1. Open File Manager from the Instrument Tool bar.
2. Select to the .cfg file to import as favorite.
3. Touch the "Add to Favorites" button (♥+).



Favorites cannot have the same name. If conflicts occur, rename the .cfg file or the existing favorite before copying.

Utilities

Applications to view test results or a fiber edge surface are provided in Utilities application.

Touching **Utilities** button displays the screen below.

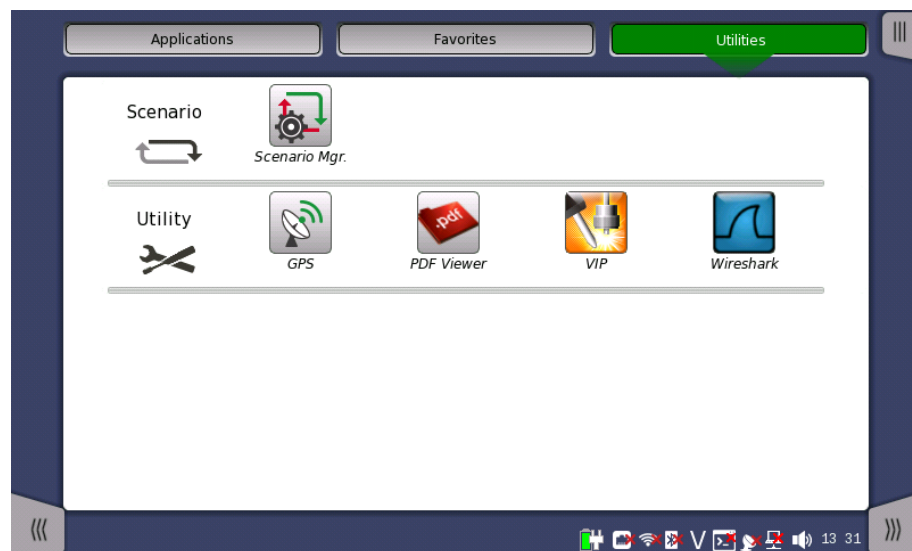

Scenario







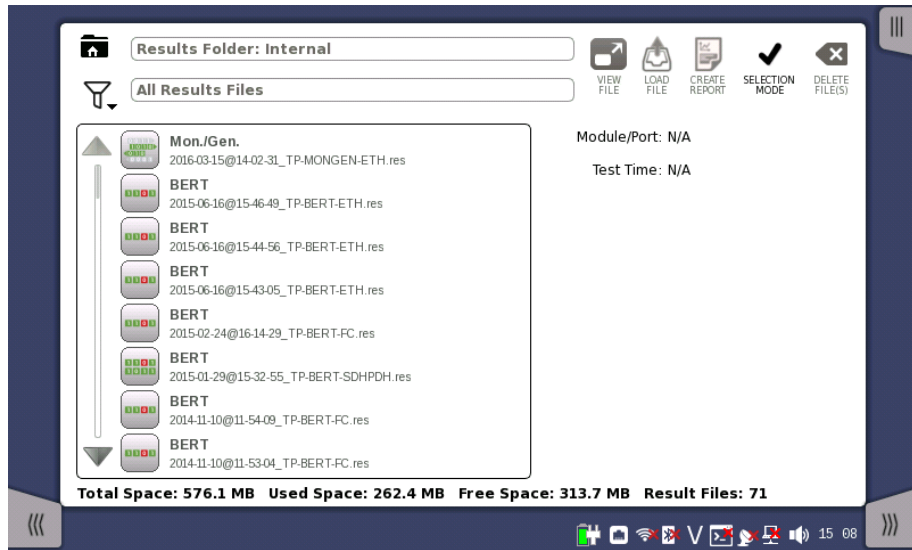

- **Scenario Mgr.:** - manages the scenario file which runs applications automatically. Parameters in the file can be edited.
- If the scenario files are loaded, the icons will appear in Scenario row.

Utility

- **GPS:** - logs data from GPS receiver and shows the position of the satellites.
- **PDF Viewer:** - to view PDF files created by [Report](#).
- **VIP:** - to view a fiber edge surface with the Video Inspection Probe (Optional Accessory). This icon appears when Video Inspection Probe is connected to a USB connector.
- **Wireshark:** - to view capture files (pcap) saved by **Frame Capture** from Ethernet applications.

Result File Browser The **Result File Browser** screen is the other entry point after startup of the Network Master. From here you can access the results of previous tests to view the statistics directly, to generate PDF reports or to do both. Refer to "[Accessing Previous Tests and Test Results](#)".



-  Browses the folder.
-  Sets the filter of files.
-  Loads the result and starts the application with view mode.
-  Loads the result.
-  Creating the report from the result.
-  Selects single file.
-  Selects multiple files.
-  Deletes the selected file(s).

In addition to the buttons for accessing and handling test results, the result file browser also contains a tab for showing/hiding the [Instrument toolbar](#) and a navigation tab to the [Application Selector screen](#).

4.1.3.2 Switching the Applications

Applications Switcher If running multiple applications, you can switch the application display by Application Switcher. There are three ways to display Application Switcher:

- In the desktop level, if two or more applications are running, touch and hold the workspace navigation button in the bottom center of the screen.
- In the workspace, touch the application in the left side of status bar.



- From the [Power Button menu](#).

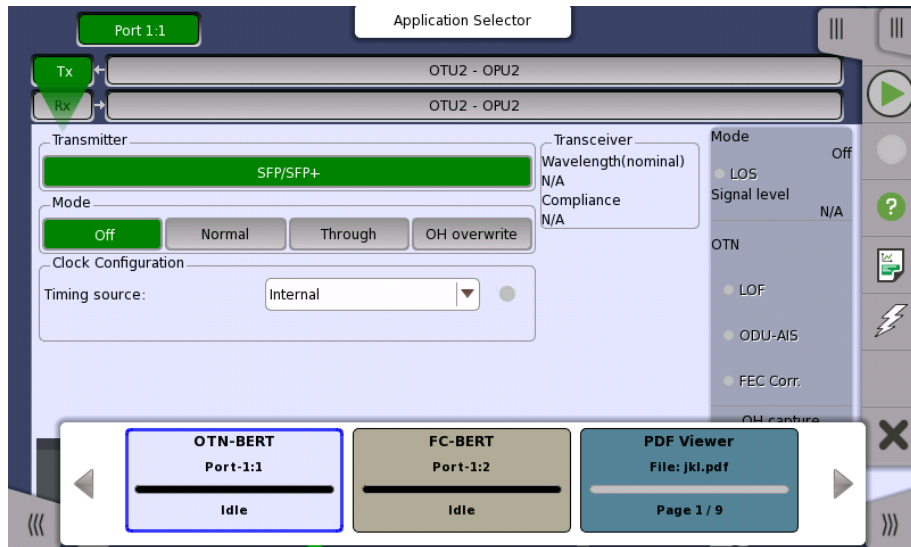

The running applications appear in the Applications Switcher. Touching the button switches the application on the screen.

4.1.3.3 Operating the Application

Ports Setup screen

The **Ports Setup** screen is the first screen in the workspace. It may contain one or more setup pages, with a row of buttons at the top of the screen allowing you to switch between the pages and between ports (when relevant).

It consists of several "areas":

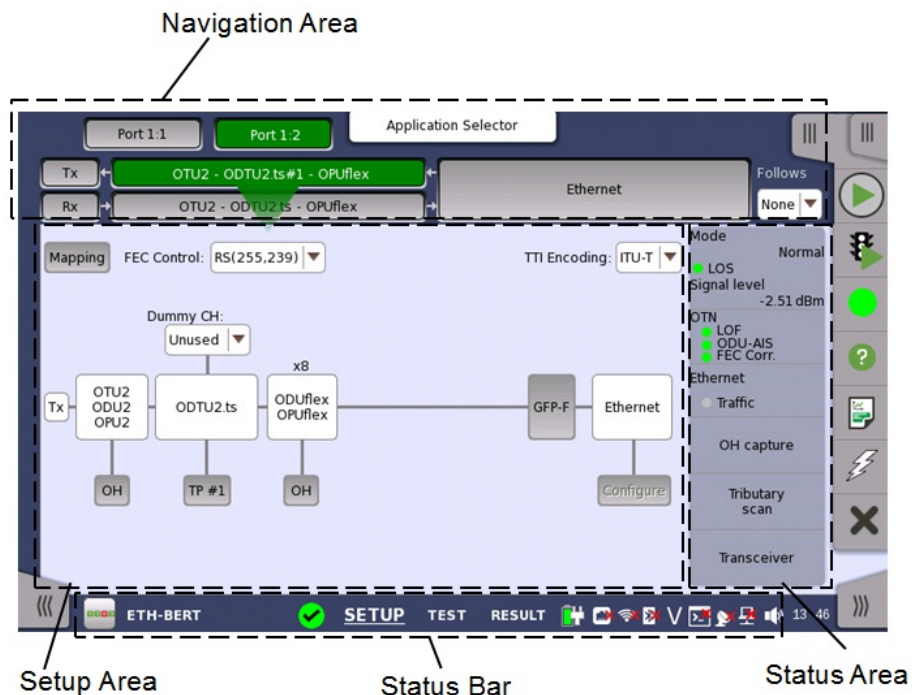

- The *navigation area* at the top of the screen contains a number of buttons representing a structure for the current interface, which allows you to select a specific port, transmitter/receiver and layer.
- The *setup area* (the main area of the screen) is where the parameters for setting up the interface are displayed. The contents of the area changes depending on what is currently selected in the navigation area.

- The *status area* (to the right of the setup area) shows status information for the currently selected port and layer. You can access more detailed status information from here by touching the status summary boxes and buttons.

It may contain one or more setup pages, with a row of navigation buttons at the top of the screen allowing you to switch between the pages and between ports (when relevant). In addition, the **Ports Setup** screen also contains the expandable [Application toolbar](#) and the navigation tabs for horizontal and vertical navigation.

Test Setup screen

The **Test Setup** screen is the second screen in the workspace. It may contain one or more setup pages, with a row of navigation buttons at the top of the screen allowing you to switch between the pages and between ports (when relevant).

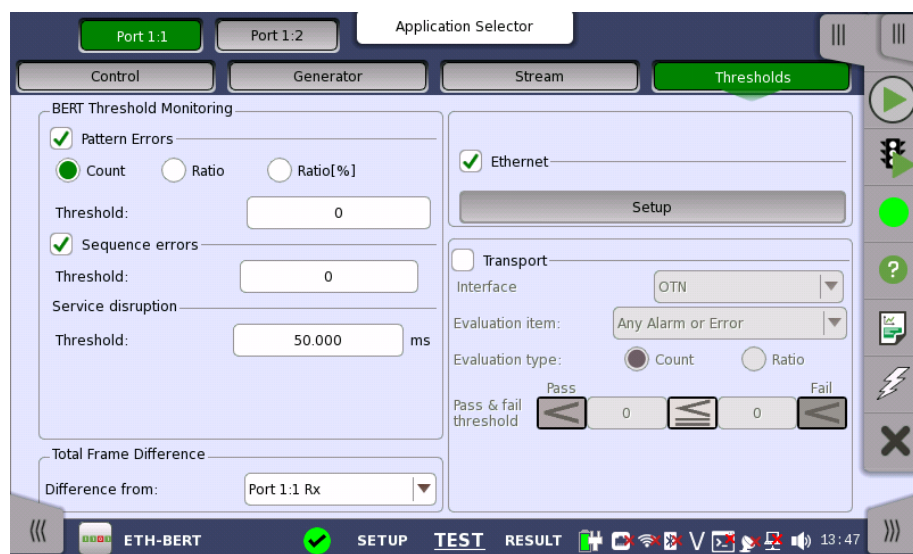

In addition to the various parameters, the **Test Setup** screen also contains the [Application toolbar](#) and the navigation tabs for horizontal and vertical navigation.

Test Results screen

The **Test Results** screen is the last screen in the workspace. It generally contains several pages, reflecting the progress of the test. Navigation buttons at the top of the screen will allow you to switch between the pages and between ports (when relevant).

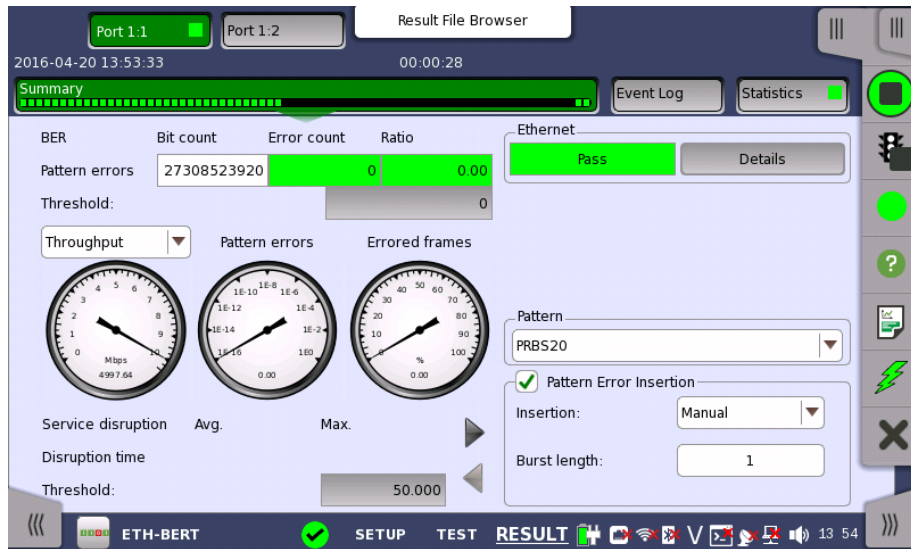

During a measurement, Measurement start time, Elapsed time, and Remaining time of measurement are displayed in Navigation area. Remaining time of measurement is not displayed if Stop function is set to **Manual stop** in Control screen.

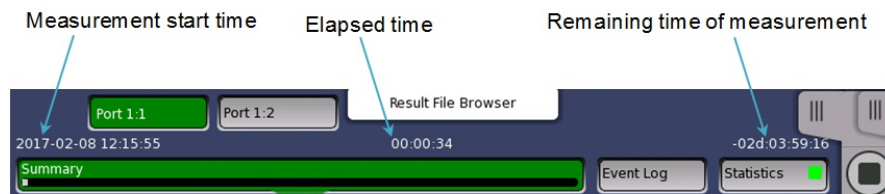

Time display during a measurement

Once a measurement ended, Measurement end time appears right-hand in Navigation area.

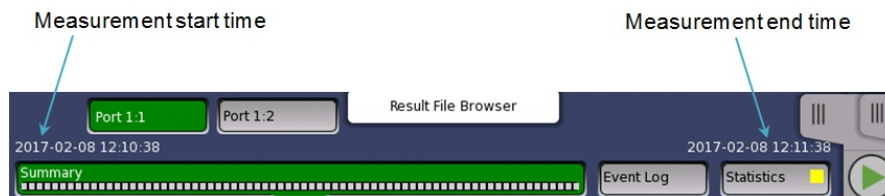

Time display after a measurement ended

In addition to the results, whose presentation varies from application to application, the **Test results** screen also contains the [Application toolbar](#) and the navigation tabs for horizontal and vertical navigation.

4.1.4 Lamp Indication of Alarm/Error Status

Alarm and error status is indicated by colored Lamp icons. The following colors are used:



Red Lamp icon indicates that an alarm has appeared.

Yellow Lamp icon indicates that an error has appeared.

Green Lamp icon indicates a 'no trouble' situation.

Note that the same colors are also used for indication of status in other contexts, e.g. in the display of test results.

Double-ringed icons with history information

The Lamp icons are double-ringed, with the inner ring indicating the current status and the outer ring showing history information (i.e. alarms and errors in the alarm trap since the last reset/clearing of history).

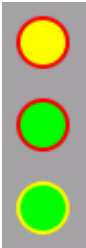

'Error' situation currently, but alarm recorded previously.

'No trouble' situation currently, but alarm recorded previously.

'No trouble' situation currently, but error recorded previously.

The example below shows the Lamp icons used in a screen displayed by selecting alarm and error status on the ports setup screen.

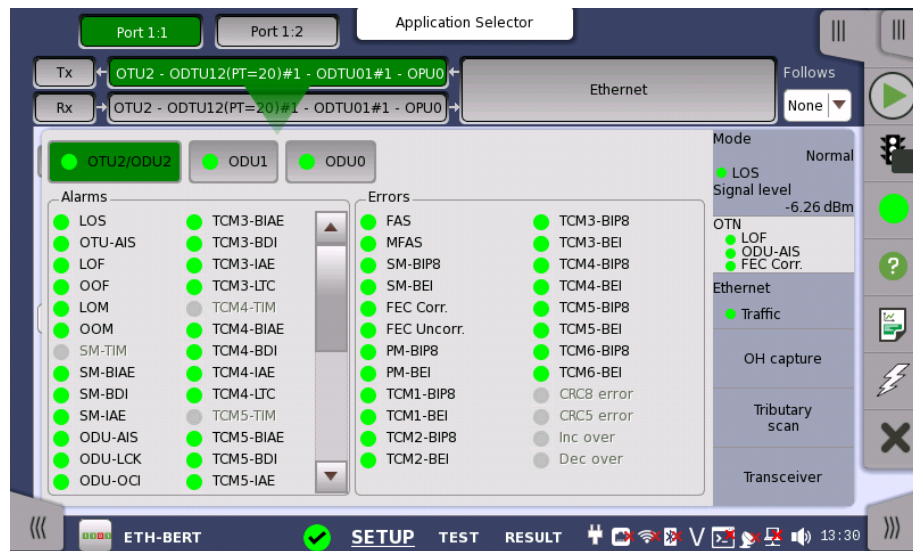

4.1.4.1 Test Status Summary

In the status bar, an icon indicates the summarized Test Status of every running test application excluding file viewers (📄) or utilities. It is possible to show/hide the summarized Test Status, refer to [Miscellaneous](#) in "Instrument Toolbar" section. The Test Status for an application is a combination of the following items:

- Thresholds violations
- Alarms/Errors

The following lists the different icons of the summarized Test Status and the their meaning.



One or more applications have alarms, had alarms in the past or have failing thresholds.



One or more applications have errors or had errors in the past.



All applications are OK.



Test Status for an application is only updated during testing. When testing is stopped it will retain its status until testing is restarted or the application is closed.

Touching the summarized Test Status icon will open a dialog showing the individual Test Status for every running applications. Touching an application on the summary dialog box will dismiss the dialog and subsequently switch the GUI to the selected application.

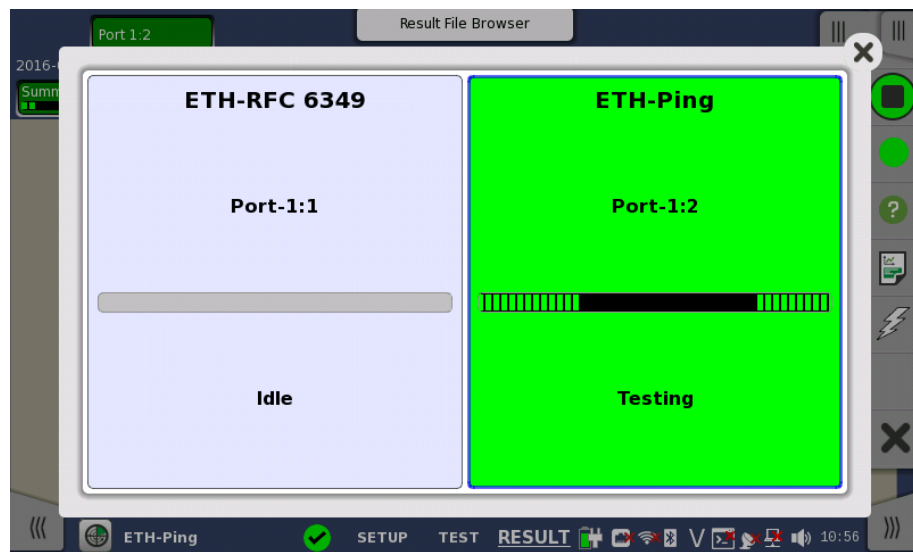

4.1.5 Keypads for Entering Text in Fields

Alphanumerical or purely numerical keypads are used to enter text in fields. By touching the field you launch the related keypad. The layout (i.e. type) of a specific keypad will depend on which type of text is required/valid for the field.



In general, a keypad consists of the character/number keys, a display field showing the current text/number entry, various editing-related keys. For number entries, the minimum and maximum values allowed are also shown. When you launch a keypad from a field, the current field value is shown in the keypad's display field.

Touch **Ok** to accept the new entry and close the keypad.

To close the keypad without accepting the change, touch **Cancel** or touch the "X" symbol in the upper right-hand corner of the keypad.

4.1.6 User Pattern Editor

The 32-bits and 2048-bits user patterns are specified using the **Pattern Editor**. You can view the pattern in either Hexadecimal, Binary or ASCII format and use either a numpad, an ASCII table or a keyboard to set it up.

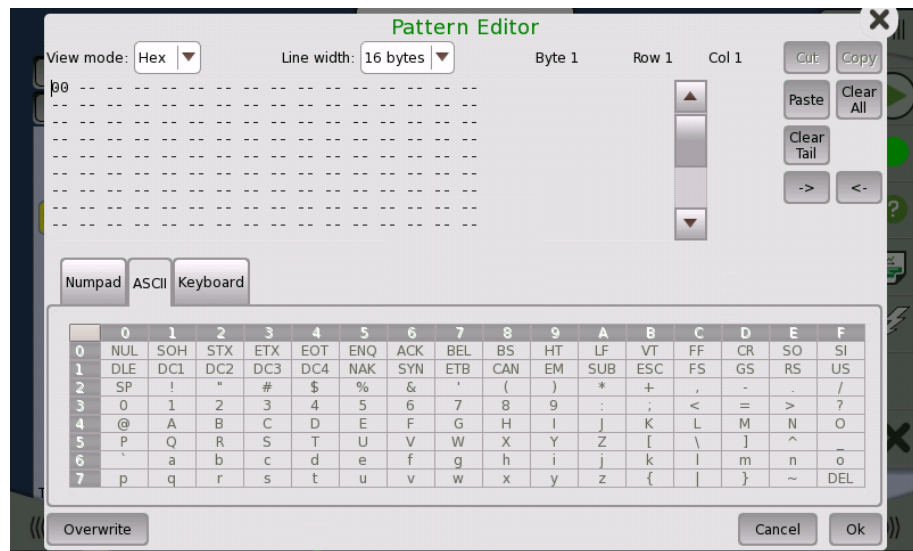

You use the numpad to edit the pattern in the *Hex* and *Bin* view modes, and use either the ASCII table or the keyboard to edit in *ASCII* view mode.

For 2048-bits user patterns, you can use the **Line Width** drop-down menu to specify how the pattern is displayed. The available values are: **2, 4, 8, 16, 32, 64** bytes.

4.1.7 Prompts to Confirm Dependencies

When a parameter change spawns changes elsewhere because of dependencies, you are prompted to accept or reject the change(s). A **Confirm Dependencies** dialog box is displayed, with information about the dependency-related changes.

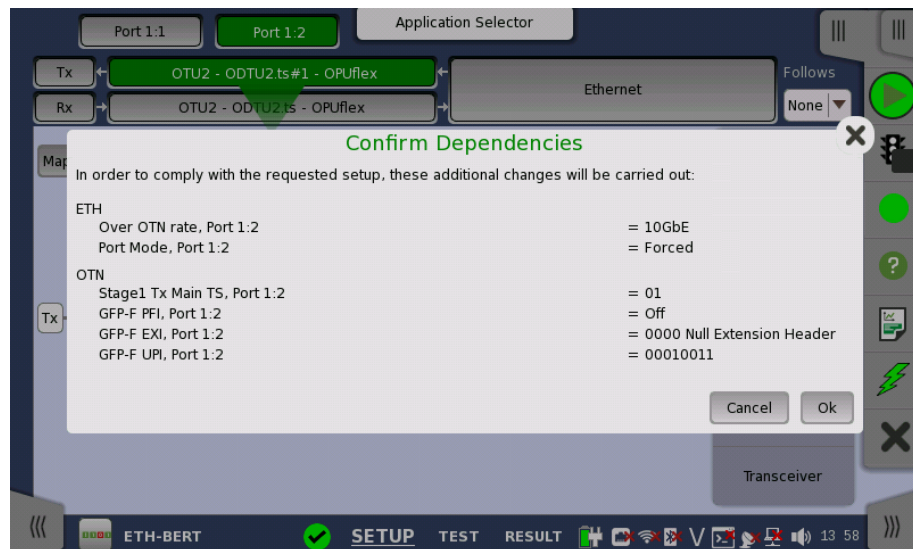

You can switch whether displaying the Confirm Dependencies dialog box. Refer to [Miscellaneous](#) in "Instrument Toolbar" section.

4.2 Toolbars

Two toolbars are available on the right-hand side of the screen: the desktop toolbar (called the *Instrument toolbar*) and the expandable workspace toolbar (called the *Application toolbar*).

- The [Instrument toolbar](#) contains general system functions and information (e.g. Instrument configuration, Battery time etc.). It is available directly on the screens related to the desktop, but can also be accessed on the workspace-related screens as a "sub-toolbar" inside the application toolbar.
- The [Application toolbar](#) contains application-related functions and information (e.g. Start/Stop test, Test progress etc.). It is available on the screens related to a specific application (i.e. all workspace-related screens), with the *Instrument toolbar* as a sub-toolbar.

4.2.1 Instrument Toolbar

The *Instrument toolbar* is shown in the figure below. When the toolbar is hidden, it is represented by its icon tab in the top right-hand corner of the screen.

Show/Hide
Instrument Toolbar



The *Instrument toolbar* contains the following functions/status:

- [Instrument Information](#)
- Configuration ([General](#), [Network](#))
- [File Manager](#)
- [Help](#)
- [Resource monitoring](#)

Instrument information



The *Information* icon launches the **System Information** screen. Touch the **Update About Info** button to generate the instrument information.

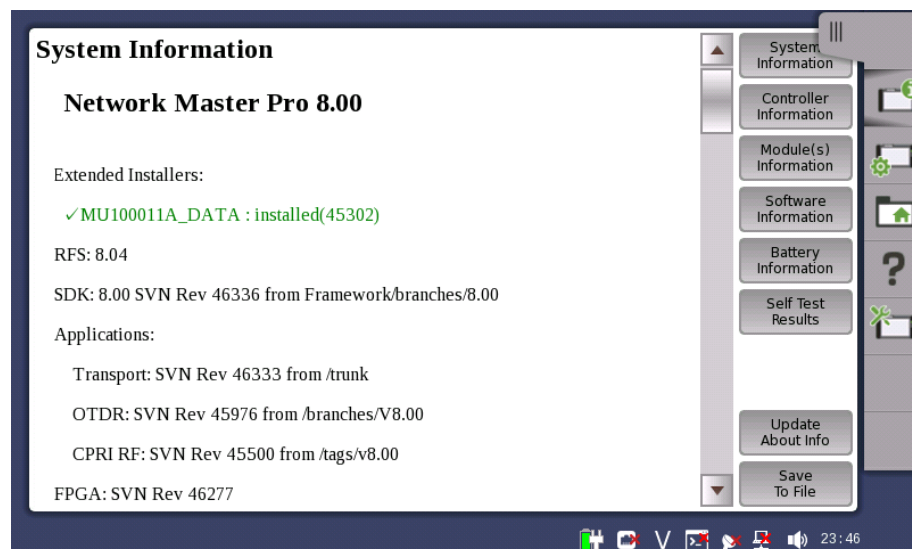

The following information is presented on the screen:

- System Information
- Controller Information
- Module(s) Information
- Software Information
- Battery Information
- Self Test Results

If MT1000A-006 is installed, "Extended Installers" is displayed. When MU100011A data is installed, the installer version is displayed.

To save the instrument information in an HTML file, touch the **Save To File** button. This launches another dialog box, where you can specify file name and location. For the icons, refer to "[File Manager](#)".

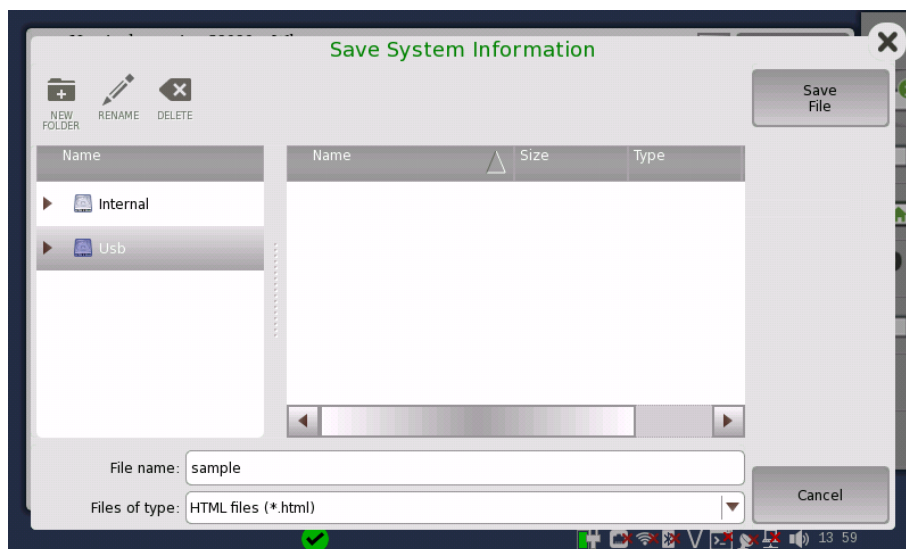

When there are "NG"s in the self test results, try to reboot Network Master. If "NG"s remain in the self test results, contact an Anritsu Service and Sales office.

Configuration



The *Configuration* icon launches the *Global Configuration* screen. From this screen, it is possible to configure both the general instrument settings (such as date/time, password etc.) and various network settings.

General

The **General** screen contains the following configuration options:

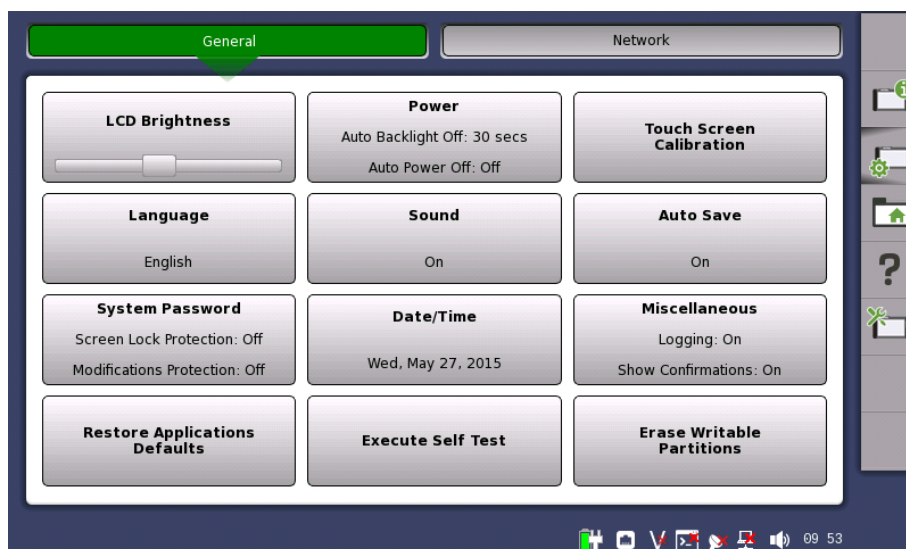

LCD Brightness

Allows you to change the screen brightness by using the slide bar.

Power

Allows you to specify auto backlight duration and auto power-off time.



*These settings are applied for the battery operation only.
When Wireshark application is running, **Auto Backlight Off** does not work.*

Touch Screen Calibration

Allows you to calibrate the touch screen. Touch **OK** in the dialog box to start the calibration.

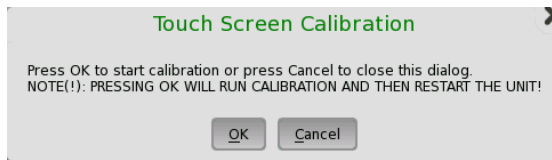

*Save the measurement results or settings before the touch screen calibration. Network Master reboots after the touch screen calibration. The measurement data which is not saved will be lost.
When operating with the battery, Network Master does not reboot.*

Language

Allows you to select language for the screens, and the keypad layout.

Sound

Allows you to specify speaker and headphones on/off. Change the volume by using the slide bar.

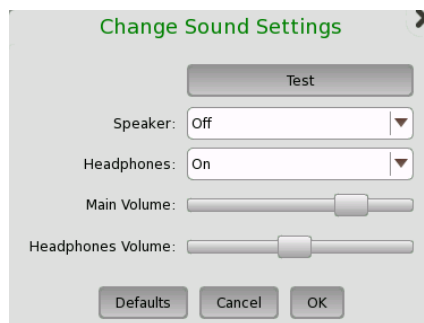

This icon indicates that the speaker is On.



This icon indicates that the speaker is Off.

Auto Save

Allows you to specify saving method of the measurement results.

- **Prompt:** Confirms saving results or not after a test.
- **On:** Saves results to the file automatically without notification every time a test ends.
- **None:** Does not save results. The results data are discarded if you do not save the data manually.

System Password

Allows you to enable/disable password protection and to specify a new password. When the password protection is enabled, starting applications and editing applications are protected.

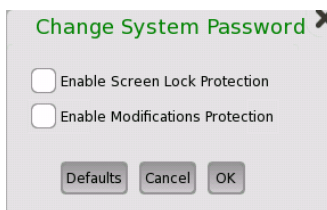

To change/set the password, select the one or more check boxes and then touch the **OK** button. A numeric keypad is displayed.

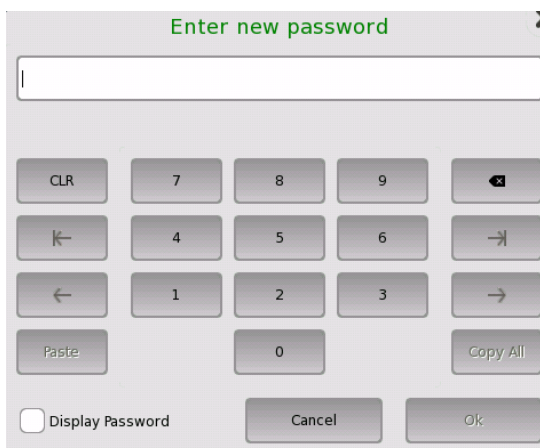

To see the numbers as you type them on the keypad, select the **Display Password** check box.



The password is set to 0614 as factory default.

Date/Time

Allows you to change the system date and time. Select a part in **New Time** or **New Date** field and touch the up/down button.

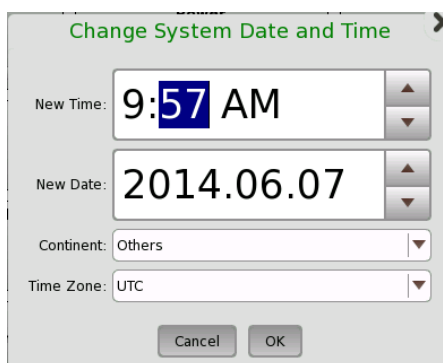

If touching **OK**, the dialog box confirming the reboot appears. Touch **Yes**.



At the battery operation, Network Master does not reboot. Date and Time will be changed when Network Master has booted by pressing the power button.

Miscellaneous

Logging Level allows you to specify the logging level. Select **Off** always. Other options are used for the service use.

Show Confirmations allows you to specify whether showing the prompts to [confirm dependencies](#).

Show Test Summary allows you to specify whether to show the summarized Test Status in the Status Bar. Refer to [Test Status Summary](#) for more details.

CSV Delimiter allows you to specify the delimiter character to be used when generating output of Comma Separated Values.

Performance Verification Period is used to calculate the performance validation due dates. Due dates are not calculated if the period is set to zero.

Enable Auto Power Up controls whether the Network Master starts automatically when the external power is applied.

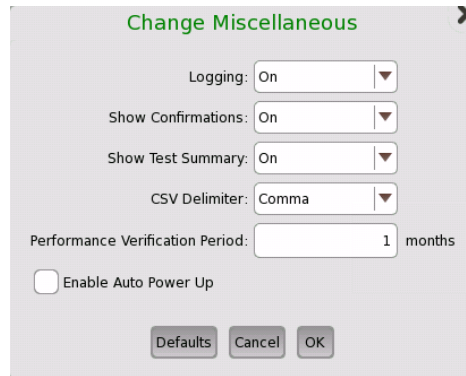

Restore Applications Defaults

Touching **Restore Applications Defaults** restores each application settings to defaults.

Execute Self Test

Touching **Execute Self Test** starts the self test.



Save the measurement results or settings of the running applications before executing the self test. Otherwise, the unsaved measurement data will be lost when Network Master reboots.

When operating with the battery, Network Master does not reboot.

Erase Writable Partitions

Occasionally it is required to remove all customer data from Network Master such as after instrument rental. Within the settings interface you can format the Network Master internal data area.

Touching **Erase Writable Partitions** erases all writable partitions^{*1} and Initialize to the unit back to factory default^{*2}.

*1: Erases all files under Internal folder including the following items.

- Scenario files included at the time of shipment^{*3}
- Scenario files created by users
- MX100001A installer for Windows^{*3}
- Wireshark lua files^{*3}
- Screen capture files

*2: Initialization of application settings

Initialization of configuration screen settings ([General](#), [Network](#))

*3: These files can be restored by re-installing the operation system installer. Refer to [Updating the Software](#) for information on installing the installer.

Network

The **Network** screen contains the following configuration options for the instrument's network connection:

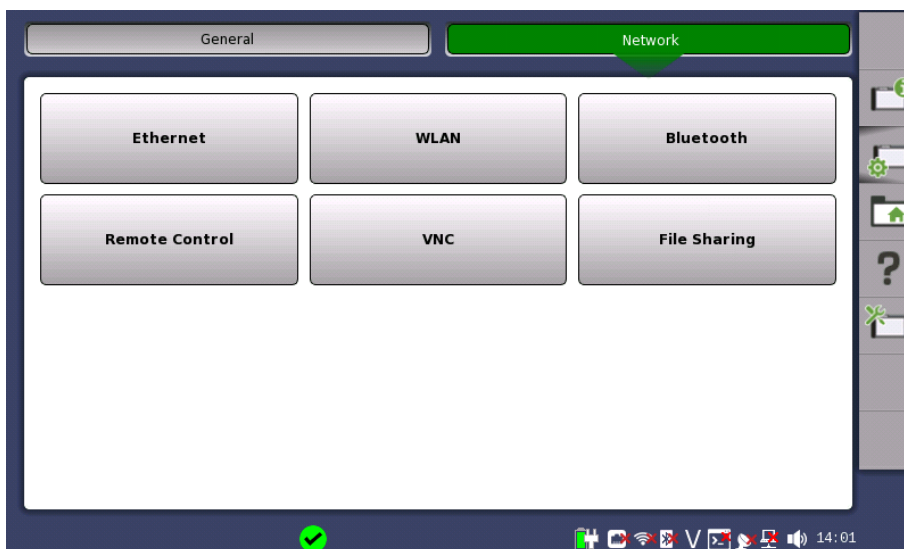

Ethernet

Allows the instrument to be connected to the Ethernet either via dynamic addressing (*DHCP*) or via manual specification of IP address, subnet mask and default gateway. These settings are applied for the [Ethernet service interface](#).

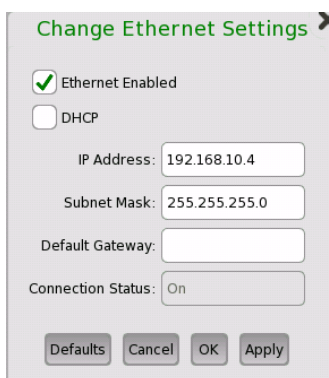

 This icon on Status bar indicates the link status of the Ethernet service interface.

WLAN

Allows the instrument to connect to a network via Wireless Local Area Network (WLAN). Note that if WLAN is enabled, the instrument cannot connect to the Ethernet via the Ethernet setting mentioned above.



This feature requires an option (MT1000A-003).

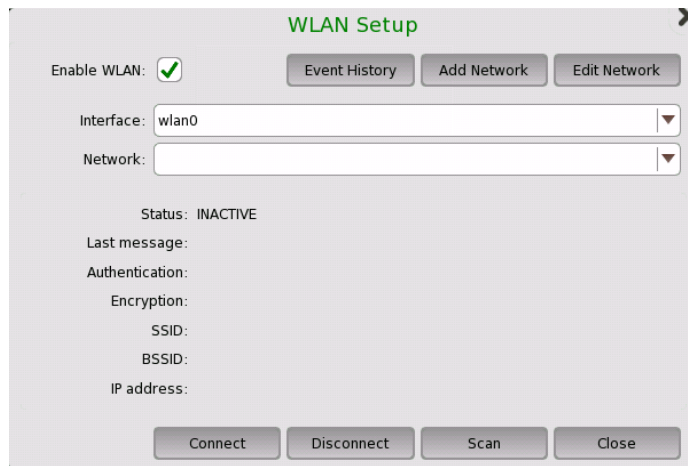

1. Touch the **WLAN** button. WLAN Setup dialog box appears.
2. Touch the **Scan** button. Scan results are displayed.
3. Select the network from scan results and touch the **View** button.
4. Touch the **Add Network** button. Specify relevant items of network, touch the **Add** button.
5. Confirm that Status in WLAN Setup dialog box changes to **Connected**.

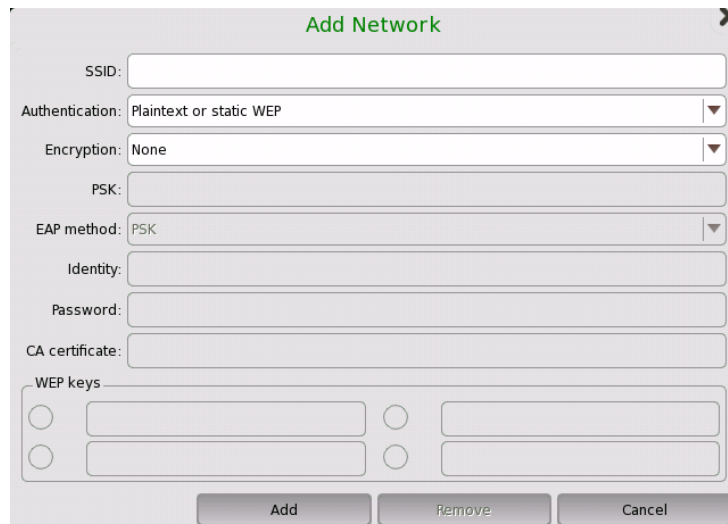

 When the option is installed, this icon on Status bar indicates the connection status of the WLAN.

To edit the settings of the current network, touch the **Edit Network** button.

The **Event History** button is available to diagnose the WLAN connection.

Bluetooth

Allows the instrument to use a Bluetooth connection.



This feature requires an option (MT1000A-003).

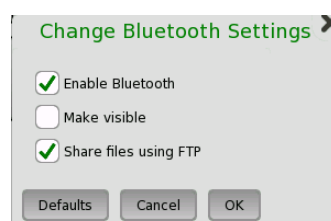

- **Enable Bluetooth:** Enables using the Bluetooth.
- **Make visible:** Allows to discover Network Master from other Bluetooth devices.
- **Share files using FTP:** Allows to share files stored in Network Master via Bluetooth. Login account and password are not required for the FTP connection. Shared folder in Network Master is "/property/mnt/internal".

 When the option is installed, this icon on Status bar indicates whether the Bluetooth is enabled or disabled.

Remote Control

Allows you to change remote control options.

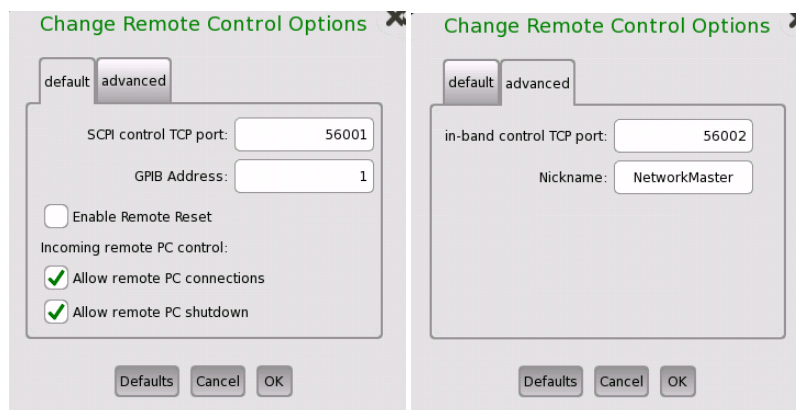



- **SCPI control TCP port:** Touch the field to set port number used for remote control via Ethernet [service interface](#).
- **GPIB Address:** Touch the field to set General Purpose Interface Bus (GPIB) address.
- **Enable Remote Reset:** Selecting the check box allows users to reset the Network Master from remote PC.
- **Allow remote PC connections:** Selecting the check box allows users to control the Network Master via Ethernet from remote PC.
- **Allow remote PC shutdown:** Selecting the check box allows users to shut down the Network Master via Ethernet from remote PC.
- **In-band control TCP port:** Touch the field to set a port number used for the remote control via the [test interface](#). Set a different number from the number set at **SCPI control TCP port**.
- **Nickname:** Touch the field to set a name of Network Master recognized by [Discovery](#) that is the Ethernet application.

 This icon on Status bar indicates whether the remote PC control is connected or not.

VNC

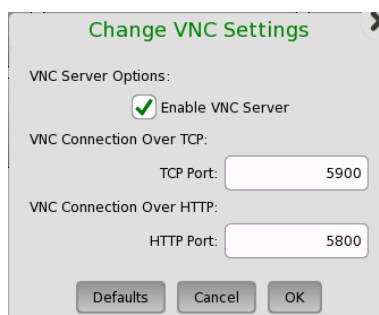
Allows remote control of the instrument via Virtual Network Computing (VNC).



 This icon on Status bar indicates whether the VNC is enabled or disabled. Touching this icon enables or disables the VNC alternately.

File Sharing

Select **Share File System** to allow to share the data folder on networked PC. Selecting **Mount Remote Folder** enables the parameter fields for mounting the folder of networked PC.

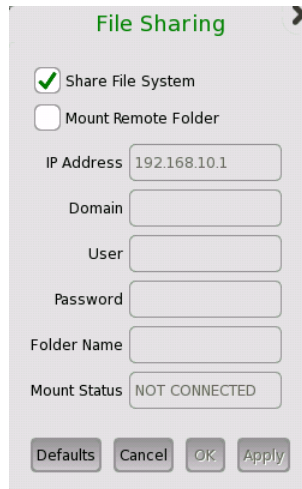

- **IP Address:** The IP address of the networked PC
- **Domain:** The domain name of the networked PC
- **User:** The username (account) of the networked PC
- **Password:** The password for account
- **Folder Name:** The name of the shared folder on the networked PC

After entering parameters, touch **Apply**. If mounting remote folder succeeded, "CONNECTED" will be shown in **Mount Status** field.



Only enter the name of the shared folder, not the entire path shown in Windows displays.

Procedure of creating the shared folder on the networked PC:

1. Create a folder on the PC.
2. Right-click on the folder and click **Properties**.
3. On the Sharing tab, click **Share** to share the folder.

The PC shared folder will be mounted to the Internal\remote folder of the Network Master.



File sharing may not be available if it is limited by Windows features settings for your PC.

For example, in case of Windows 10 Fall Creators Update (version 1709), the **Mount Remote Folder** check box is not available for security reasons.

Though there is an increased security risk, you will be able to use the **Mount Remote Folder** feature according to the following procedure:

1. On the Windows Start menu, click **Control Panel**.
2. Click **Programs and Features**.
3. Click **Turn Windows features on or off**.

4. Select the **SMB 1.0/CIFS File Sharing Support** check box, and then click **OK**.

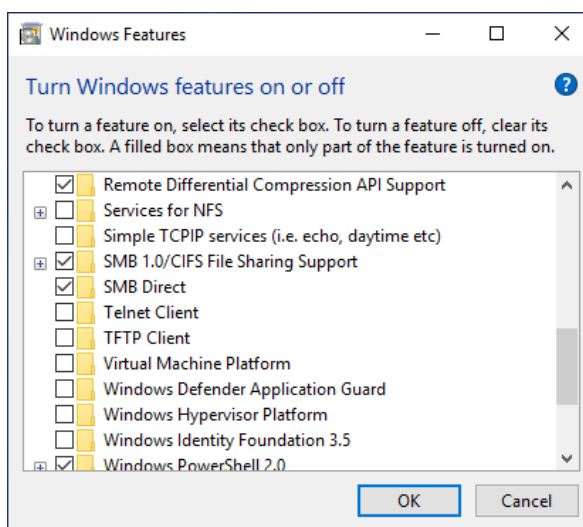









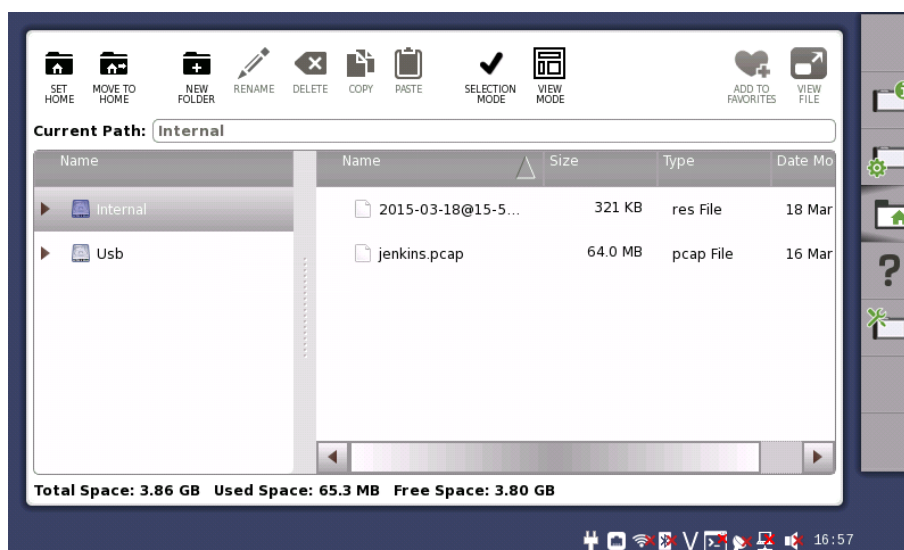





5. Restart Windows.

File Manager



The *File Manager* icon launches the file manager screen. From this screen it is possible to configure the instrument's internal file storage facility as well as to perform all kinds of file transactions, both internally and from/to any external file storage source (USB memory stick etc.).







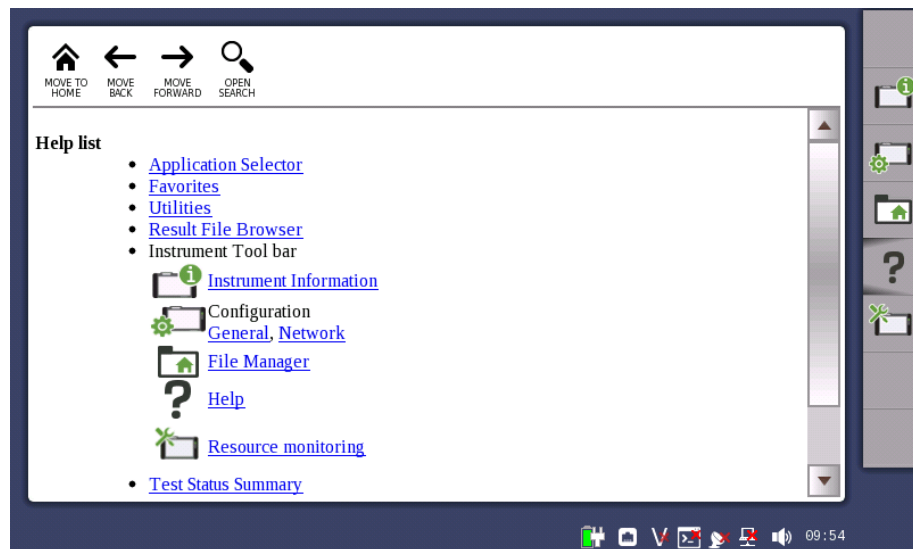

-  Appears on the remote control application screen only.
Displays the local folder of the control PC.
-  Appears on the remote control application screen only.
Displays the folder of the Network Master.
-  Sets the current folder to the home folder.
-  Moves to the home folder.
-  Creates a new folder.
-  Edits the file name or the folder name.
-  Deletes the selected file(s) or folder(s).
-  Copies the selected file(s) or folder(s).
-  Pastes the file(s) or folder(s).
-  Selects a file or a folder.
-  Selects multiple files or folders.
-  Switches the GUI layout.
-  Adds the selected files (.cfg) to "Favorites".
-  Shows contents of a text file.

Help



The *Help* icon launches the help screen with context-related help. You can search for specific words or phrases in the help and also step through previously displayed help topics.



-  Moves to the Help list topic.
-  Back
-  Forward
-  Shows/hides the search box and buttons at bottom.
-  Searches backward.
-  Searches forward.

When **Case Sensitive** is selected, searches distinguishing the upper case and the lower case.

Resource monitoring



The **Resource monitoring** icon launches a screen showing which applications are currently activated and which ports on the connector panel are assigned to each of the applications.

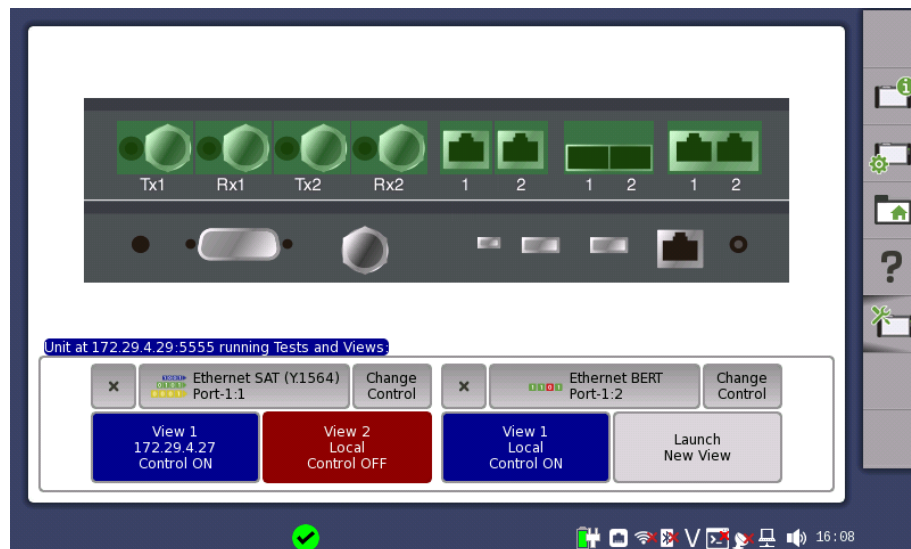

Each application is associated with up to two Views, Only one View can have control at a time. Having control gives user full access to all application functions, including modification of setting parameters, load and save functions, and running the test. Without control, users are only allowed to browse the current application settings and results.

- Touch **Launch New View** button to launch a new View.
- Touch the **Change Control** button to pass control between Views:
 - Red background indicates a View that does not have control.
 - Blue background indicates the View in control.
- Touching a View local to you, will automatically show the desktop of the associated application.
- Touch the 'X' to force termination of an application and its Views and the release of the associated port resources. This is the only way to terminate an application over which you do not have control.

When the Network Master is being controlled by Control Software, the text set in **Optional client Title Text** of the Control Software is displayed on the button.

4.2.2 Application Toolbar

The *Application toolbar* consists of two columns plus the *Instrument toolbar*. You can expand/collapse the toolbar as shown in the figure below. The left-most column, which is always displayed, contains the most commonly used functions and status indicators.

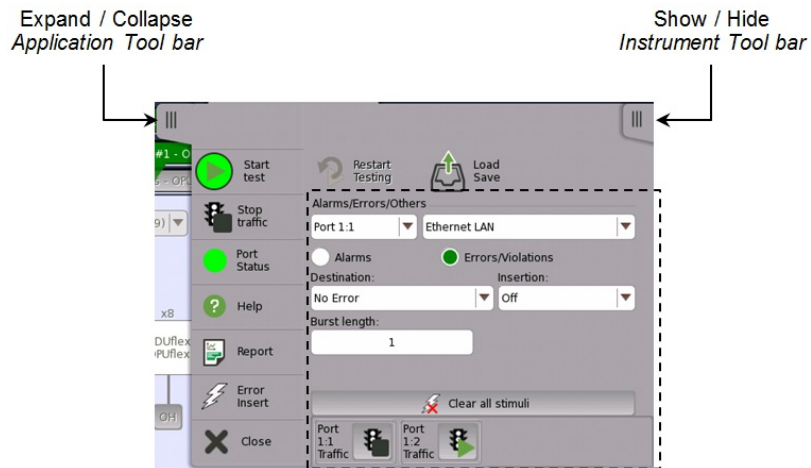

Left-most column

The left-most column contains the following functions and status indicators:

Start



Touch the **Start** icon to start the currently selected application/test. The icon changes to the **Stop** icon shown below, which can then be used to stop the test.

Stop



Touch the **Stop** icon to stop the currently running application/test. The back color indicates the pass/fail status. When the test has stopped, the icon changes to the **Start** icon shown above.

Traffic Start



This icon appears in case of applications having traffic generation. Touch the **Traffic Start** icon to start sending traffic of all ports under test. The icon changes to the **Traffic Stop** icon shown below.

Traffic Stop



This icon appears in case of applications having traffic generation. Touch the **Traffic Stop** icon to stop the traffic of all ports under test. When the traffic has stopped, the icon changes to the **Traffic Start** icon shown above.

Port Status



Shows the current pass/fail status of the test. *Green* means pass, *red* means fail.

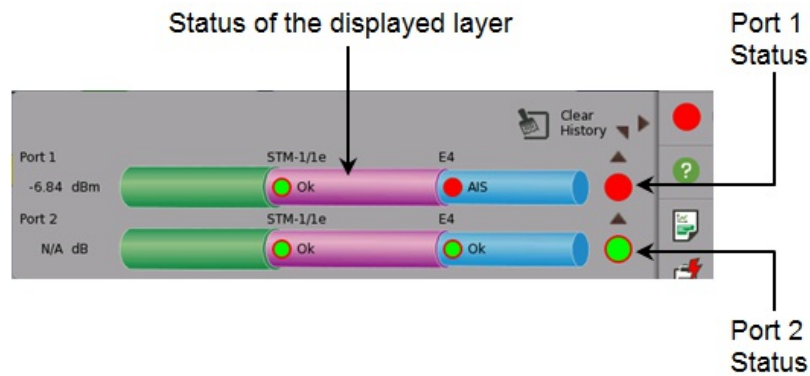

Port Status is the summary of all ports under test. If a failure occurs in any layer, Port Status turns into red.

Help



Touch this icon to access the online help for the currently displayed screen or dialog box. You can search for specific words or phrases in the help and also step through previously displayed help topics.

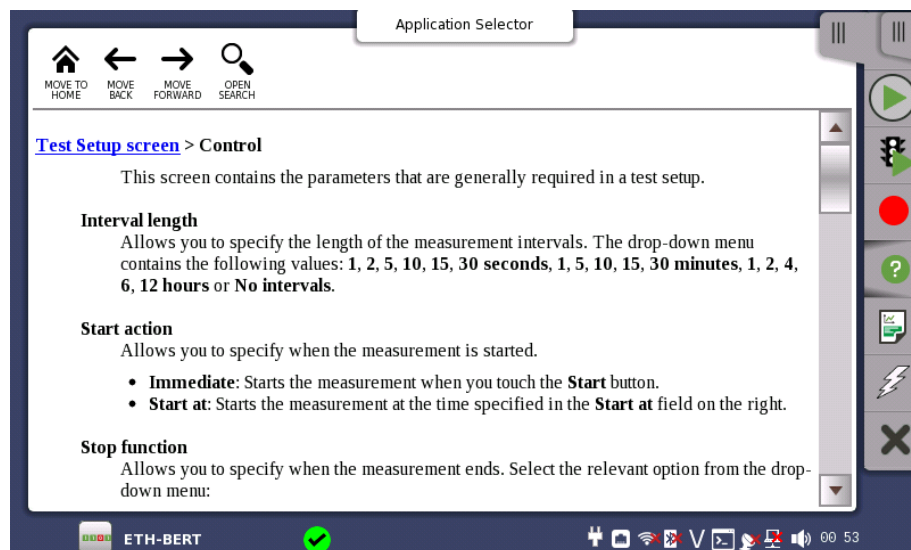

- Moves to the topic when touching the help icon.
- Back
- Forward
- Shows/hides the search box and buttons at bottom.
- Searches backward.
- Searches forward.

If **Case Sensitive** is selected, searches distinguishing the upper case and the lower case.

Report



Touch this icon to create a report containing the current application results and settings.

1. Touch the **Select Format** field to select the format of the report file. The application name is shown in **Select Report** field.

2. Touch fields of **Customer**, **Project**, **Operator** and **Notes** to set strings. These contents are output in the report.
3. To print a logo in the report, select the **Include Logo** check box. Touching ... button launches the dialog box selecting a file.
4. Select **Include Performance Verification dates** check box to print Performance Verification dates in the report.
5. Touch **Next** button.

6. Select check boxes of items outputting to the report. Touching **Customize** button launches the dialog box selecting items of statistics.
7. Touching **Generate** button starts the report generation.



Adobe® Reader® is recommended as a PDF viewer to open or print out the report.



"Include Performance Verification dates" check box appears in version 3.01 or later.

Creating reports from the Result File Browser will not take up port resources on the system. From the Result File Browser, select the result file for which you want to create a report and touch the Report icon (📄).







The Report Generator will remember previous used setup parameters. The first page is common for all applications while setup parameters on subsequent pages are remembered on a per application basis.

Alarm/Error Insert



Touch this icon to activate the stimulus specified in the stimuli setup available in the expanded *Application toolbar*. Only relevant if the stimulus has been set to manual insertion. The *stimuli function* is used to generate special or abnormal conditions during a test.

The color of the icon is coded according to the current level of stimuli inserted. The different levels are prioritized so that higher levels of stimuli overrule lower levels. The overall highest stimuli level (see the list below) for all ports included in the application is reflected.

-  Red: Alarms are currently being generated. (highest level)
-  Yellow: Errors are currently being generated.
-  Green: No alarms/error are automatically inserted. Active stimuli require manual insertion by touching the **Alarm/Error Insert** icon.
-  Blue: Frequency, Pointer, or Payload offset stimulus is currently applied. (lowest level)
-  White: All stimulus is disabled.

Close



Touch this icon to close the application.

Expanded Application toolbar

The *Application toolbar* is expanded/collapsed by touching the  tab placed above the left-most column. The column displayed in the expanded toolbar contains the following functions:

Restart Testing



Touch this icon to restart the current test.

Load Save



Touch this icon to open Load/Save dialog box. You can load or save Setup file or Result file. Only files matching the current application type are selectable for loading.



When loading setup files, the number of port resources enclosed in the file has to match that of the current application.

When loading result files, the exact physical ports enclosed in the file has to match that of the current application.

Apart from actual results, result files also contain settings sampled at the time the test was performed. When loading result files these settings will overwrite current application settings.



Loading result files into a viewer will not take up port resources on the system. This is practical if you only want to review previous results and don't need to run test again. From the Result File Browser, select the result file you want to view and touch the View icon (📄) at right hand top of the screen.

Stimuli setup

Various fields and buttons are available for setting up a stimulus signal to provoke a special or abnormal situation during the test. When the signal has been specified, the stimulus is sent by touching the **Alarm/Error Insert** icon (⚡).

The stimulus signal is sent via the transmitter, and the received signal can simultaneously be inspected as a related status or result display. This allows to evaluate the behavior of the device under test.

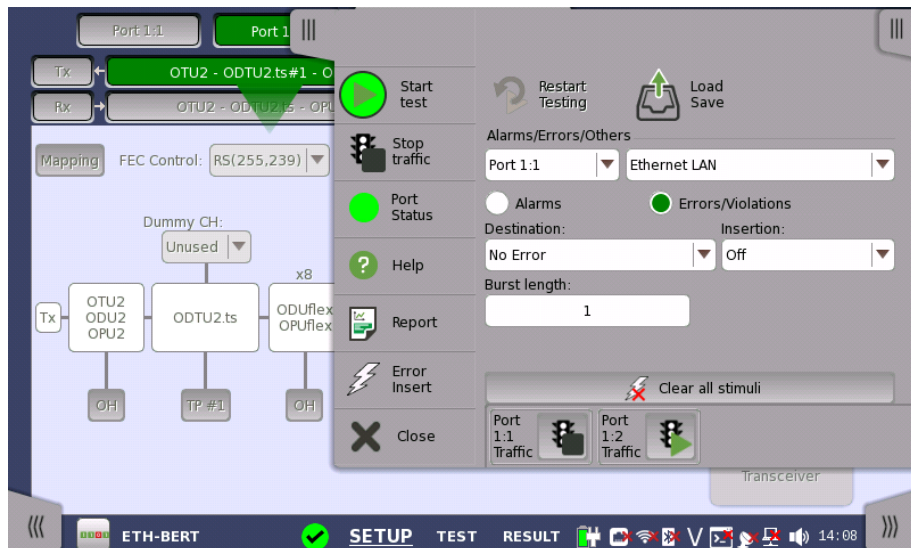

The setup options vary depending on the stimulus mode (i.e. the signal type). Common functions for all stimulus modes are the port selection and stimulus type drop-down menus. Touching the **Clear all stimuli** button clears/resets the current stimulus settings.

In case of applications having traffic generation, the Traffic start button or the Traffic stop button appears for each port.

4.3 Startup and Switch-off Sequences

This section describes what takes place when you switch the Network Master on and off as well as when you start up and close down an application.

4.3.1 Instrument Startup

When you switch on the instrument, the first screen displayed is a splash screen - introducing you to the GUI concept of the *desktop/workspace* and the various screen types (see the figure in the *GUI Concept* section). Then the [Application Selector](#) screen is displayed.

4.3.2 Application Startup

When you touch an icon on the *Application Selector* screen to start an application, a *workspace* is created for that application and the relevant data is loaded into it. When the loading is complete, you are prompted to select the instrument resources (i.e. ports) that will be allocated to the application/test.

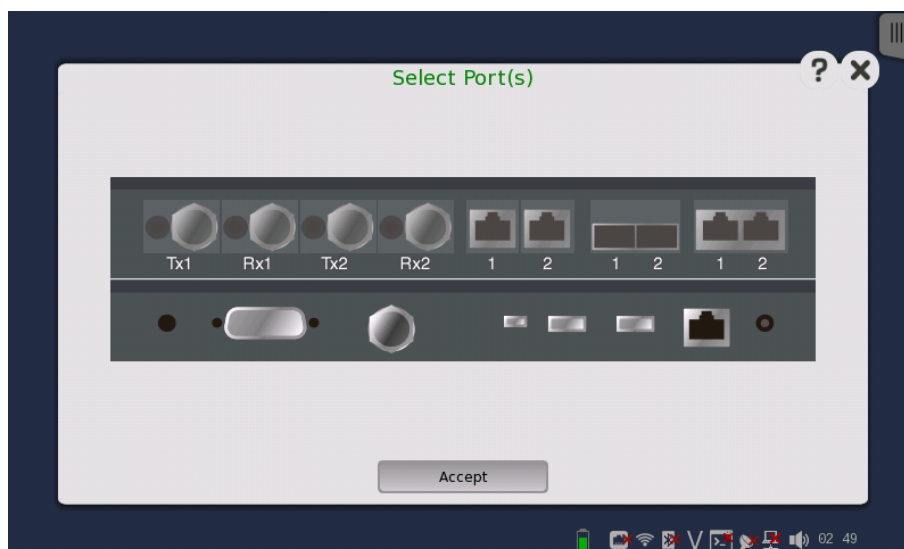

After the selection of resources, the *Ports Setup* screen is displayed, with the interface type(s) relevant for the selected application.



Some of the application icons are "double-icons", allowing you to start the application with an OTN signal layer if relevant. Be careful to touch the correct part of the icon when starting the application.

You can also start an application by selecting the result file on the *Report File Browser* screen. Refer to the next section.

25G eCPRI/RoE Dual Port Ability



25G eCPRI/RoE Dual Port Ability appears only when the MU100011A-075 Advanced 25G eCPRI/RoE is installed.

When you touch an eCPRI/RoE BERT icon in MU100011A, the **25G eCPRI/RoE Dual Port Ability** check box appears. Selecting the check box allows users to use the 25 Gbps interface for both ports. However, you cannot launch applications other than eCPRI/RoE BERT. For the details, refer to [To enable using 25 Gbps for two ports on eCPRI/RoE BERT application](#).

4.3.3 Accessing Previous Tests and Test Results

When you select test result files on the *Report File Browser* screen, you can choose to create either a report from the results or a *workspace* containing the test setup data and its results.

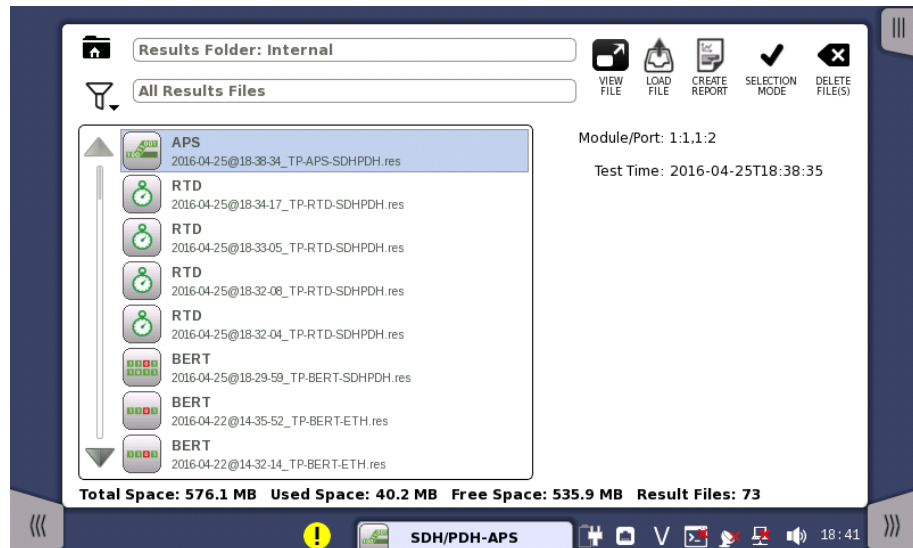

Creating a *workspace* for a previous test allows you to view the test results in the GUI and also to rerun the test if required (either with the same setup or with changed parameter settings). You are brought directly to the *Test Results* screen when you touch the **View/Load File** button, but can navigate to the other screens in the workspace from there.



When you touch the **VIEW FILE** button, an application starts in *Viewer* mode. In this mode, you cannot start measurement. This mode is used to view the test result.



When you touch the **LOAD FILE** button, an application starts using the setting in the file. If other application is using ports, the following message appears. In this case, you can start the application in *Viewer* mode.

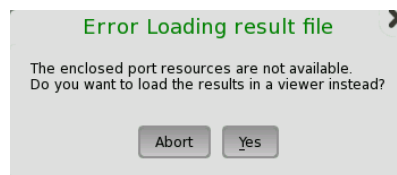

When you touch the **CREATE REPORT** button, the file manager dialog box is displayed, allowing you to name and save the report (in PDF format).

4.3.4 Closing an Application

When you touch the **Close** icon in the *application toolbar*, you are prompted to confirm that you really want to close the current application. If you touch "Yes", the *workspace* is closed and you are returned to the *desktop* (i.e. the *Application Selector* screen). The resources previously allocated to the application are freed to be used by another application if required.

4.3.5 Switching Off the Instrument

When you press the [Power button](#) on the instrument, the power-off menu is displayed. The menu contains the menu item **Shut Down**, and when you select that, you are prompted to confirm that you really want to switch off the instrument completely.

If you touch "Yes", the shutdown is announced, and then after a few moments the power is turned off.



If you have any applications still active when you switch off the instrument, these applications will be closed automatically without any configuration data and/or test results being saved.

5 SDH/SONET/PDH/DSn Applications

This chapter describes the graphical user interface (i.e. screens, sub-screens and major dialogs) related to SDH/SONET/PDH/DSn applications. Sub-screens and dialogs are described under the main screen from which they are activated/launched.

The following settings and applications are available:

- [SDH Setup and Status](#)
- [SONET Setup and Status](#)
- [E1 Setup and Status](#)
- [DS1/J1 Setup and Status](#)
- [E3 Setup and Status](#)
- [DS3 Setup and Status](#)
- [E4 Setup and Status](#)
- [APS](#)
- [BERT](#)
- [RTD](#)



You can switch between SDH and SONET using the '[SDH/SONET switching](#)' drop-down menu on the SDH and SONET structure setup screens. 'SDH and SONET switching' also switches PDH and DS_n.

5.1 SDH Setup and Status

An **STM-xx** button in the navigation area of the [Ports Setup](#) screen gives you access to the SDH setup for the transmitter and/or receiver of the currently selected port.

Refer to [SDH/SONET switching](#) for switching to SDH.

Synchronous Digital Hierarchy (SDH) is a standardized protocol that transfers digital signals over optical fiber using lasers. At low transmission rates data can also be transferred via an electrical interface.



The SDH interface uses the electrical BNC connectors and the optical ports.



MU100010A Connector Panel



MU100011A Connector Panel

5.1.1 Transmitter Setup

5.1.1.1 Physical Setup

When the transmitter is set up with an SDH interface, touching the **Tx** button in the navigation area will launch the following screen. (Note that the **SDH Tx** check box above the connector panel illustration is selected.)

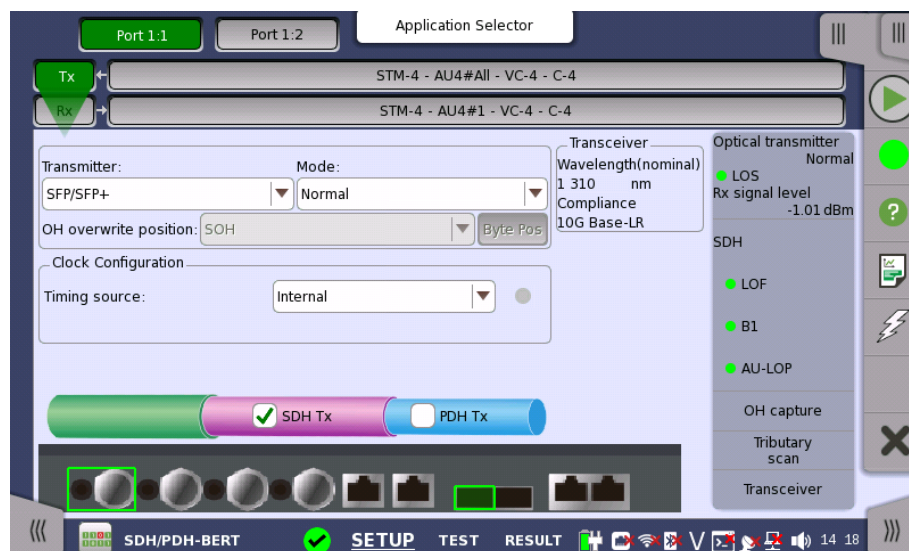

This screen allows you to enable the optical or electrical interface of the SDH transmitter. It can also be used to confirm the current status of the selected port.

The configuration options available in the setup area of the screen are described below. The status information is described in a separate section.

Transmitter

Use the **Transmitter** drop-down menus to select to the transmitter.

Mode

Use the **Mode** drop-down menus to select to the behavior of the transmitter.

OH overwrite position

Only enabled when the **OH overwrite** has been selected to the behavior of the transmitter. Use the drop-down menu to select the relevant overwrite position.

The available values are:

- SOH
- A1/A2 byte
- K1/K2 byte
- S1 byte
- DCC1-3 byte
- DCC4-12 byte
- J0 byte
- 1 byte of SOH

When '1 byte of SOH' is selected, touch the **Byte Pos** button to launch the **1 Byte of SOH** dialog box. Select the byte to overwrite in the dialog box.

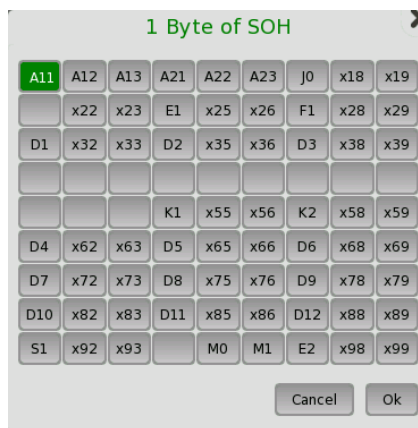

Clock Configuration

Use the drop-down menu to select the clock source. This is fixed to **Received** when the Port Mode is set to **Through** or **OH overwrite**.

Timing Source

Internal: Internal clock of the module

External: The clock input to the connector

Received: The clock generated from the received signal

When **External** or **Received** is set, the right hand lamp indicates whether clock is detected or not.

Transceiver Displays the Transceiver information when the option except "Electrical" is selected to the transmitter.

5.1.1.2 SDH Frame Setup

Touching the navigation area button which represents the transmitter's SDH layer will launch the following screen.

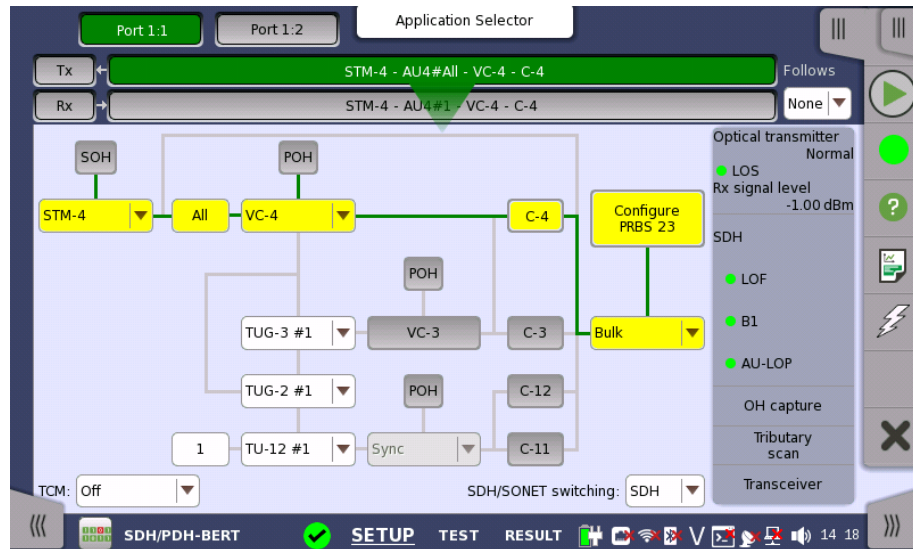

The general principle in setting up the SDH frame is to select the relevant values for the various containers in the multiplexing structure. This is done either via a drop-down menu or via a launched dialog box, by touching a drop-down menu or a button in the frame structure diagram.

Note that the currently 'active path' in the structure is highlighted. Note also that the changes you make will be reflected in the text displayed in the **STM-xx** button in the navigation area, if relevant.

Follows To make the Port 2 transmitter follow the Port 1 transmitter (i.e. copy its settings), touch the right-most button in the navigation area and select the **Tx1** in the drop-down menu. The Port 2 settings continue to follow the Port 1 transmitter change. The default setting is **None**. Note that the Port 1 transmitter cannot follow the Port 2 transmitter.

TCM Select the *TCM* (Tandem Connection Monitoring). The available TCM is decided by multiplex structure. If you select other TCM, the multiplex structure on the setup area will be changed.

The possible settings are:

- Off
- N1 (VC-4)
- N1 (VC-3)
- N2 (VC-12/11)

SDH/SONET switching Allows you to switch between SDH and SONET.

SOH Editor You can configure the section overhead (SOH) in a special dialog box (**SOH Editor**), which is launched when you touch the **SOH** button.

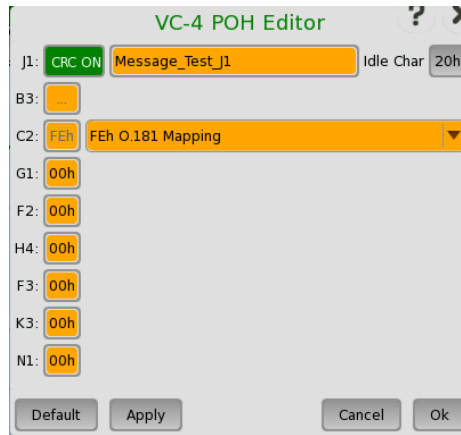

- **J1:** Path Trace
Idle Char is an ASCII code used for the padding.
- **B3:** Path BIP-8 This byte cannot be set.
- **C2:** Signal label
- **G1:** (bit 1 to 4) REI (bit 5) RDI (bit 6 and 7) Reserved (bit 8) Spare
- **F2,F3:** Path user channels
- **H4:** Multiframe indicator
- **K3:** (bit 1 to 4) Automatic protection switching (APS) channels (bit 5 and 6)
Spare (bit 7 and 8) Data link
- **N1:** Network operator byte

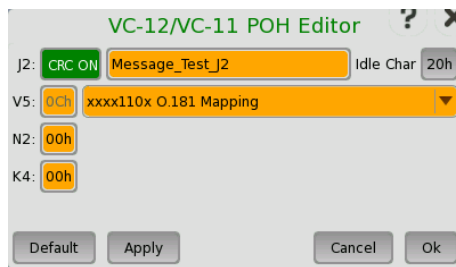

- **J2:** Path Trace
Idle Char is an ASCII code used for the padding.
- **V5:** (bit 1 and 2) BIP-2 (bit 3) REI (bit 4) RFI (bit 5 to 7) Signal label (bit 8) RDI
- **N2:** Network operator byte
- **K4:** (bit 1) Extended signal label (bit 2) Low order virtual concatenation (bit 3 and 4) Automatic protection switching (APS) channels (bit 5 to 7) Reserved (bit 8) Data link

Bulk Pattern

To set up the bulk pattern, touch the **Configure xxxxx** button to launch the **Bulk Pattern** dialog box.

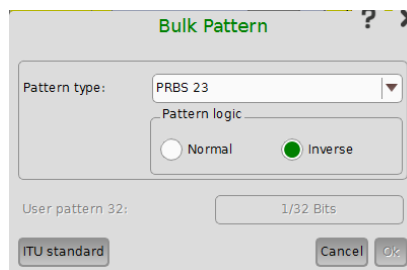

Pattern type

Select a predefined pattern or define a user pattern.

- **User [32] bit, User [2048] bit:** 32 bits or 2048 bits length pattern.

The field which shows bit length is enabled. Touch the field to launch the dialog box to define the bit pattern. Refer to [The User Pattern Editor](#).

- **PRBS9 to PRBS31**: Pseudo-random bit sequence. The number indicates the bit length of sequence.

For example, bit length of PRBS9 is $2^9-1=511$.

Pattern logic is enabled.

- **All 0's, All 1's**: All bits are 0, all bits are 1.
- **Alternating 1:1, Alternating 1:3, Alternating 1:7**: Bit pattern such as "010101...", "100010001000...", "1000000010000000...".
- **2 in 8**: Bit pattern such as "010000100100001001000010...".

ITU Standard

Touching the 'ITU standard' button will apply standard recommended **Pattern type** for currently selected SDH frame.

- C-4: PRBS 23 Inverse
- C-3 (VC-4): PRBS 23 Inverse
- C-3 (VC-3): PRBS 15 Inverse
- C-12: PRBS 15 Inverse
- C-11: PRBS 15 Inverse

5.1.2 Receiver Setup

5.1.2.1 Physical Setup

When the receiver is set up with an SDH interface, touching the **Rx** button in the navigation area will launch the following screen. (Note that the **SDH Rx** check box above the connector panel illustration is selected.)

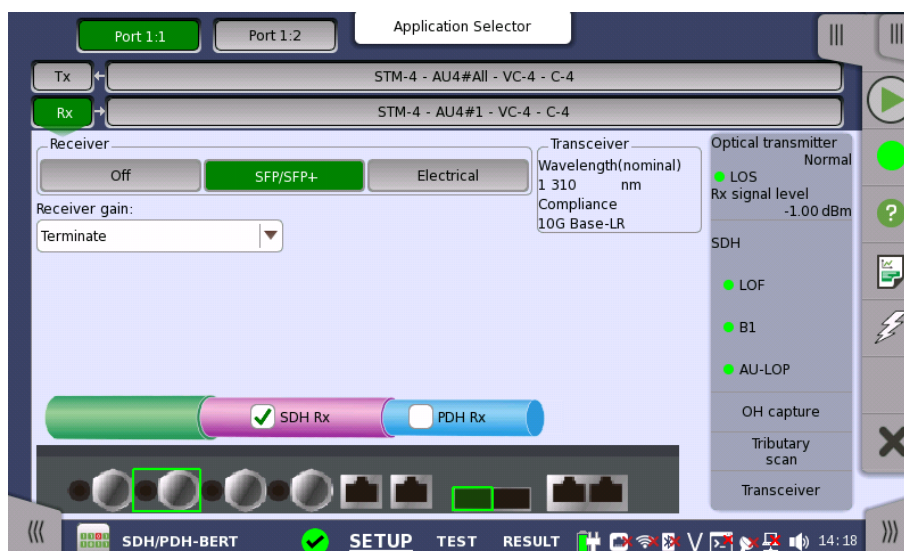

This screen allows you to make the physical setup of the receiver in SDH mode. It can also be used to confirm the current status of the selected port.

The configuration options available in the setup area of the screen are described below. The status information is described in a separate section.

Receiver

Touch the button corresponding to the relevant interface type.

- **Off**: No interface

- **SFP/SFP+**: Optical interface
- **Electrical**: Electrical interface (BNC connector)

Receiver gain Only relevant for electrical receivers. Select the attenuation and impedance mode from the drop-down menu.

- **Terminate**: Up to 12 dB cable attenuation, nominal impedance
- **Monitor**: 20 dB linear attenuation and up to 12 dB cable attenuation, nominal impedance.

Transceiver Displays the Transceiver information when Optical Transmitter is selected.

5.1.2.2 SDH Frame Setup

Touching the navigation area button which represents the receiver's SDH layer will launch the following screen.

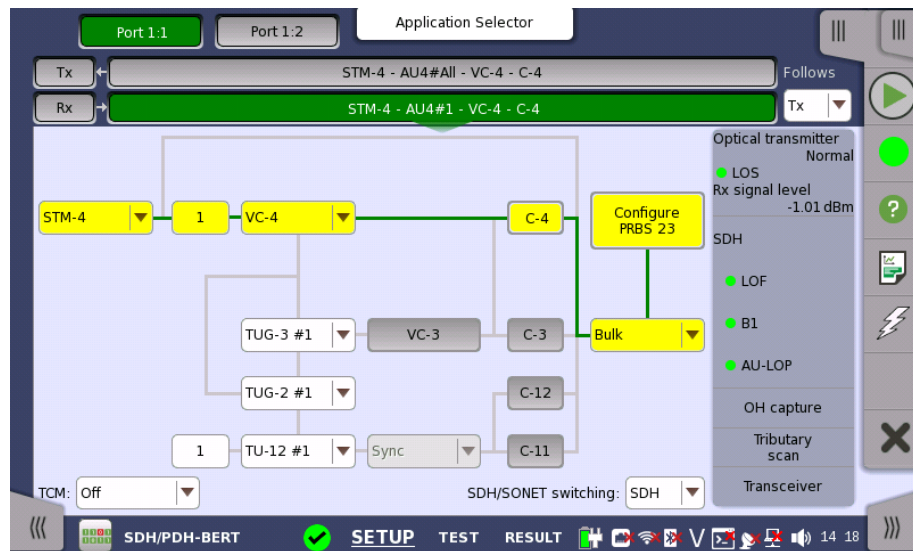

The manner of setting up the SDH interface of receiver is the same as that of transmitter. Refer to [SDH Frame Setup](#) in "Transmitter Setup".

Follows To make the currently selected receiver follow either the transmitter or Port 1 receiver (i.e. copy its settings), touch the right-most button in the navigation area and select the relevant value in the drop-down menu. The receiver settings continue to follow the change of either the transmitter or Port 1 receiver. The default setting is **None**. Note that the Port 1 receiver cannot follow the Port 2 receiver.

TCM Select the *TCM* (Tandem Connection Monitoring). The available TCM is decided by multiplex structure. If you select other TCM, the multiplex structure on the setup area will be changed.

The possible settings are:

- Off
- N1 (VC-4)
- N1 (VC-3)
- N2 (VC-12/11)

SDH/SONET switching Allows you to switch between SDH and SONET.

5.1.3 Status Information

This section describes the status information available for the SDH layer in the status area of the **Ports Setup** screen.

5.1.3.1 Status Summary

The status summary displayed for the SDH layer consists of the following information:

Physical Status

The topmost part of the status area gives you access to information about the current physical status of the selected interface. A summary consisting of the most relevant status indicators is displayed constantly. By touching the summary, you can launch a display that contains the detailed status information.

Alarm/Error Status

The middle part of the status area gives you access to alarm and error information for the selected interface. The status is indicated by the lamp color.

A summary consisting of the most relevant alarm/error indications is displayed constantly. By touching the summary, you can launch a display that contains all alarms/errors.

Capture/Monitor Status

At the bottom of the status area are below buttons that give you access to various capture/monitor information. By touching a button, you can launch the corresponding information display.

- OH capture
- Tributary scan
- Transceiver

5.1.3.2 Physical Details

Touching the topmost summary box in the status area of the **Ports Setup** screen launches the dialog box shown below.

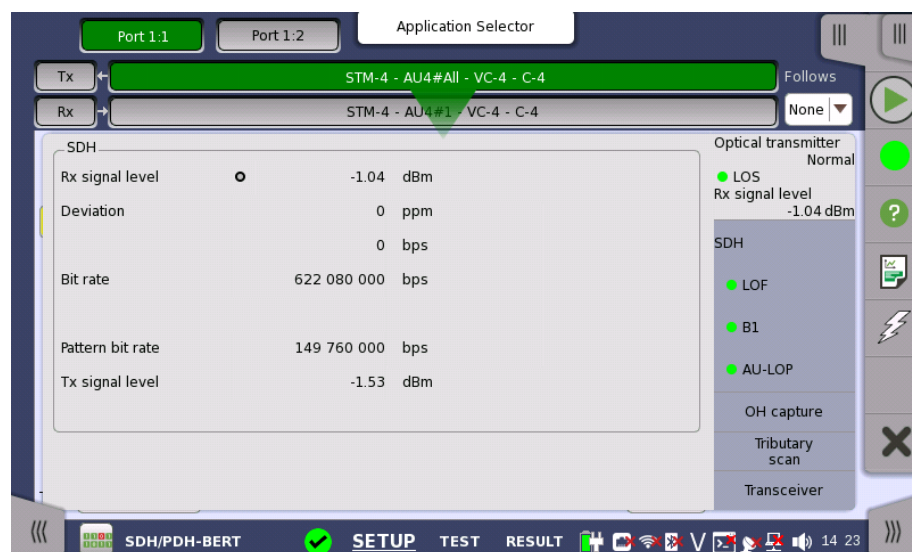

This dialog box presents detailed information about the current physical status of the received signal at the STM-1/4/16/64 optical/electrical interface.

The physical status information consists of the following parameters.



When Receiver is set to OFF, 'N/A's are displayed.

Rx signal level

- Signal Level (Optical) shows the optical signal level in dBm.
- Signal Level (Electrical) shows the electrical signal level in dB.

'nan' is displayed when input level is too low to detect the signal level. The lamp indicates LOS status.

Deviation

This field shows the deviation from the relevant nominal bit rate:

- STM-1/1e: 155 520 000 bps
- STM-4: 622 080 000 bps
- STM-16: 2 488 320 000 bps
- STM-64: 9 953 280 000 bps

Bit rate

The current bit rate is shown (in bps).

Pattern bit rate

This field shows the effective bit rate of the patterns received (that is, the number of pattern bits received per second).

Tx signal level

When optical is selected, this field shows the output power of the optical transmitter.

When electrical is selected, 'N/A' is displayed.

5.1.3.3 Alarms and Errors

Touching the middle summary box in the status area of the **Ports Setup** screen allows you to launch the display shown below.

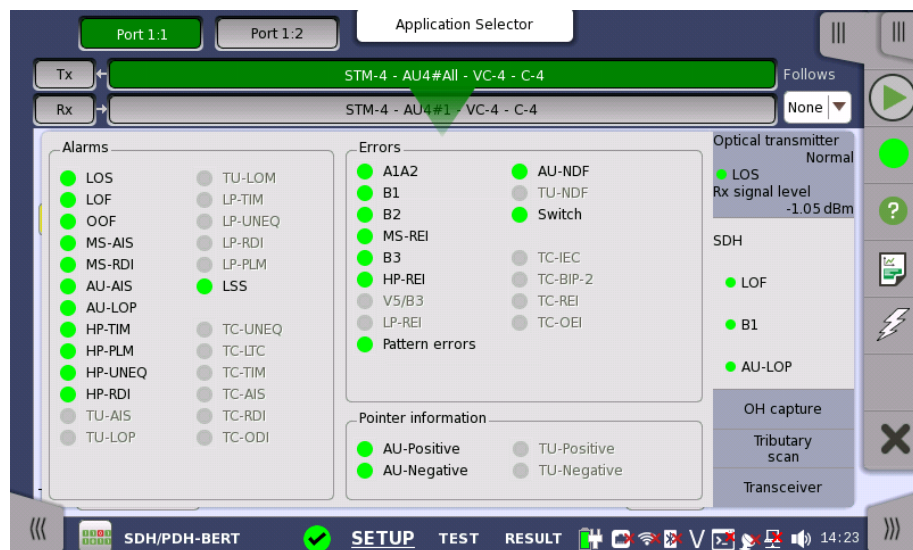

This screen contains detailed alarm and error information related to the SDH interface. Status is indicated by the use of [colored Lamp icons](#).

Alarms

- **LOS**: Loss of Signal
- **LOF**: Loss of Frame
- **OOF**: Out of Frame
- **MS-AIS**: Multiplex Section Alarm Indication Signal
- **MS-RDI**: Multiplex Section Remote Defect Indication
- **AU-AIS**: Administrative Unit Alarm Indication Signal
- **AU-LOP**: Administrative Unit Loss of pointer
- **HP-TIM**: High order Path Trace Identifier Mismatch
- **HP-PLM**: High order Path Payload Mismatch
- **HP-UNEQ**: High order Path UNEQuipped
- **HP-RDI**: High order Path Remote Defect Indication
- **TU-AIS**: Tributary Unit Alarm Indication Signal
- **TU-LOP**: Tributary Unit Loss of pointer
- **TU-LOM**: Tributary Unit Loss of Multiframe
- **LP-TIM**: Low order Path Trace Identifier Mismatch
- **LP-UNEQ**: Low order Path UNEQuipped
- **LP-RDI**: Low order Path Remote Defect Indication
- **LP-PLM**: Low order Path Payload Mismatch
- **LSS**: Loss of Sequence Synchronization
- **TC-UNEQ**: Tandem Connection UNEQuipped
- **TC-LTC**: Tandem Connection Loss of Tandem Connection
- **TC-TIM**: Tandem Connection Trace Identifier Mismatch
- **TC-AIS**: Tandem Connection Alarm Indication Signal
- **TC-RDI**: Tandem Connection Remote Defect Indication
- **TC-ODI**: Tandem Connection Outgoing Defect Indication

Errors

- **A1A2**: Bytes used for the frame synchronization
- **B1**: The byte of BIP-8 (Bit Interleaved Parity 8)
- **B2**: The bytes of BIP-N×24 (Bit Interleaved Parity N×24)
- **MS-REI**: Multiplex Section Remote Error Indication
- **B3**: The byte of BIP-8 (Bit Interleaved Parity 8)
- **HP-REI**: High order Path Remote Error Indication
- **V5/B3**: BIP-2 of VC-12/VC-11 or BIP-8 of Low order VC3
- **LP-REI**: Low order Path Remote Error Indication
- **Pattern errors**: Bit error detected in the payload
- **AU-NDF**: Administrative Unit New Data Flag
- **TU-NDF**: Tributary Unit New Data Flag
- **Switch**: APS switching occurred
- **TC-IEC**: Tandem Connection Incoming Error Count
- **TC-BIP-2**: Tandem Connection Bit Interleaved Parity-2
- **TC-REI**: Tandem Connection Remote Error Indication
- **TC-OEI**: Tandem Connection Outgoing Error Indication

Pointer Information

- **AU-Positive**: Administrative Unit Positive stuffing
- **AU-Negative**: Administrative Unit Negative stuffing
- **TU-Positive**: Tributary Unit Positive stuffing

- **TU-Negative:** Tributary Unit Negative stuffing

5.1.3.4 OH capture

Touching the **OH capture** button in the status area of the **Ports Setup** screen launches the screen shown below.



This screen shows SDH capture status information for one frame at a time. The frame number captured in one time is 64. Touch the frame selection buttons to select which frame to display.

The position of A1, A2 bytes in SOH for STM-4/16/64, refer to description in [SOH Editor](#).

Refreshing information

Refresh once

When touch the **Pause** button, the **Update** button is showed at left side of the **Pause** one and information is not updated. Touching the **Update** button will refresh the dialog information once.

Refresh continuously

When the dialog is open and touch the **Pause** button at refresh once mode, information is updated continuously.

Displaying detailed information

Detailed overhead byte information can be accessed by touching a specific byte. This will launch a separate dialog containing a description of and details about the selected byte.

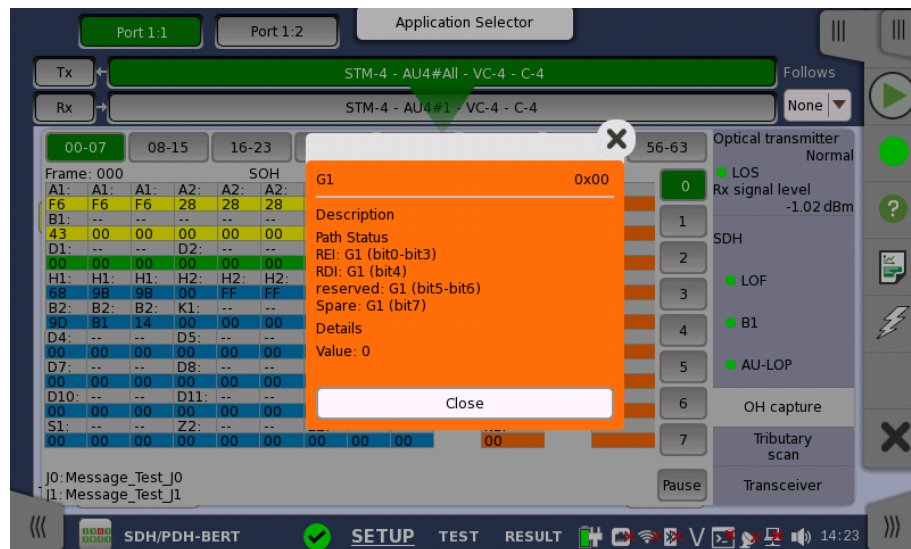

5.1.3.5 Tributary scan

Touching the **Tributary scan** button in the status area of the **Ports Setup** screen displays the status shown below.

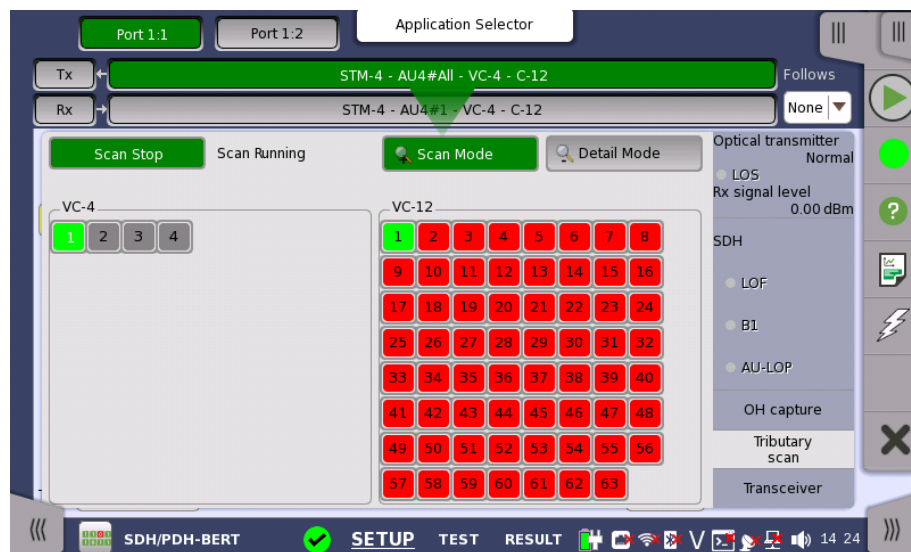

This screen allows to measure the alarms and errors of all VC-containers in the High order or the Low order at the same time. Note that the Low order scan is performed against the High order channel which you have selected.

Scanning

This button appears when the Low order channel exists. In Scan Mode, touch the **Scan Start** button to start the scanning. To stop the scanning touch the **Scan Stop** button (same button, which toggles between the two functions).

Details

To view detailed information for a specific channel, touch the **Detail Mode** button and then touch the channel number.

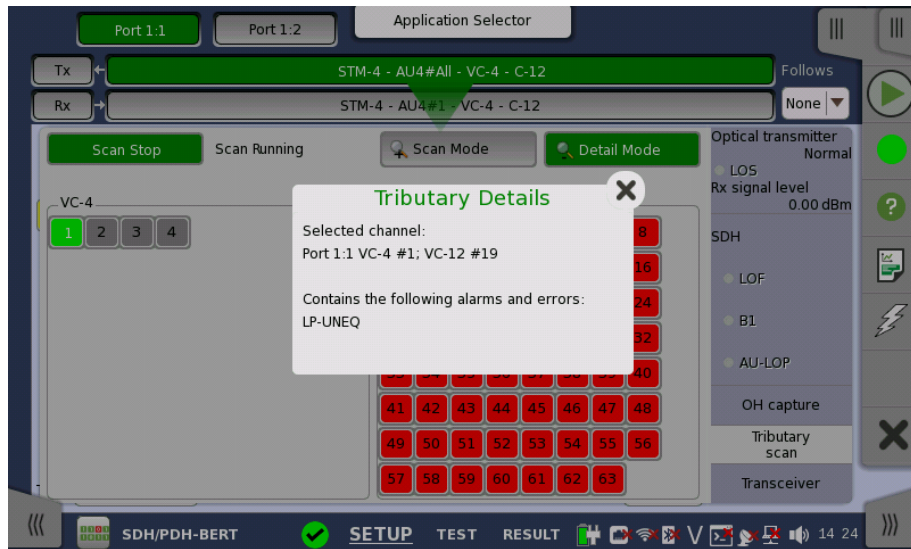

5.1.3.6 Transceiver

Touching the **Transceiver** button in the status area of the **Ports Setup** screen launches the dialog shown below.

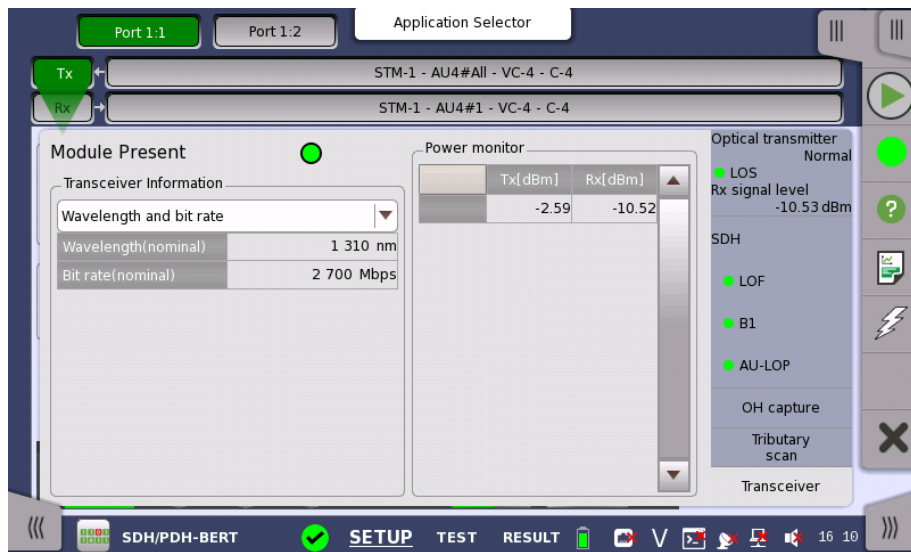

This dialog box presents status information about the optical transceiver.

When the optical transceiver is SFP or SFP+, [I2C analysis](#) appears. Refer to description of [Transceiver](#) in Ethernet Applications.

Module Present

Green indicates that an optical transceiver is currently mounted.

Transceiver Information

Select the information from pull down menu.

- **Wavelength and bit rate** shows the nominal wavelength and bit rate.
- **Compliance** shows the available standards.
- **Vendor information** shows the data stored in the optical transceiver.

Tune wavelength

When the optical transceiver is a tunable SFP, following items are displayed for **Wavelength and bit rate**.

Bit rate, Channel, Wavelength, Frequency, First frequency, Last frequency, Grid spacing

Transceiver Information	
Wavelength and bit rate	
Bit rate(nominal)	11 300 Mbps
Channel	36
Wavelength	1552.50 nm
Frequency	193.1000 THz
First frequency	191.3500 THz
Last frequency	196.1000 THz
Grid spacing	50.0 GHz

Touching **Channel** or **Wavelength** value opens the dialog box to set the wavelength.

Power monitor

The optical power read out from the transceiver is displayed.

The transmitting optical power is displayed in left column. The received optical power is displayed in right column.

5.1.4 Errors/Alarms Insertion

This section describes the errors or alarms insertion for the SDH layer on the [Application toolbar](#).

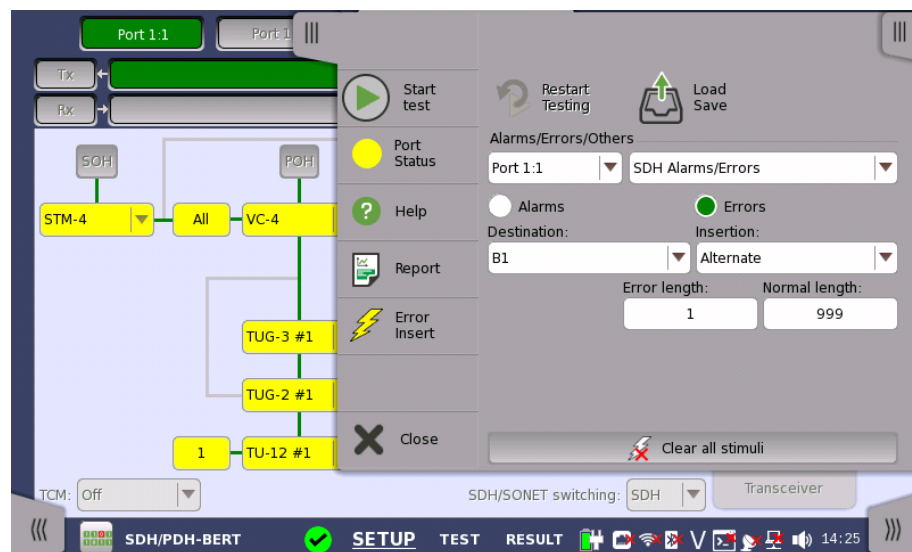

Alarms/Errors/Others

Select the port to insert errors, and the stimuli type. The settings items vary depending on the selected stimulus type.

- **SDH Alarm/Errors:** Inserts errors or alarms related the SDH overhead or the pattern error.
- **SDH frequency:** Adds the frequency offset to the SDH bit rate.
- **SDH pointer:** Inserts specified pointer continuously.

5.1.4.1 SDH Alarms/Errors

1. Select **Alarms** or **Errors** using the radio button.
2. Select the **Destination**.
3. Select the **Insertion**.
 - **Off:** Turns off inserting Alarms or Errors.
 - **Manual:** Inserts errors or alarms in the specified counts if you touch the Error Insert icon.

- **Permanent:** Inserts errors or alarms in all SDH frame. The Error Insert icon shows only status.
- **Alternate:** Repeats error/alarm insertion per specified number of frames. The Error Insert icon shows only status.
- **1E-03 to 1E-10:** Inserts errors in the specified rate continuously. For example, **1E-03** means 10^{-3} . In this case, the error will be inserted in one frame per one thousand frames. The Error Insert icon shows only status.

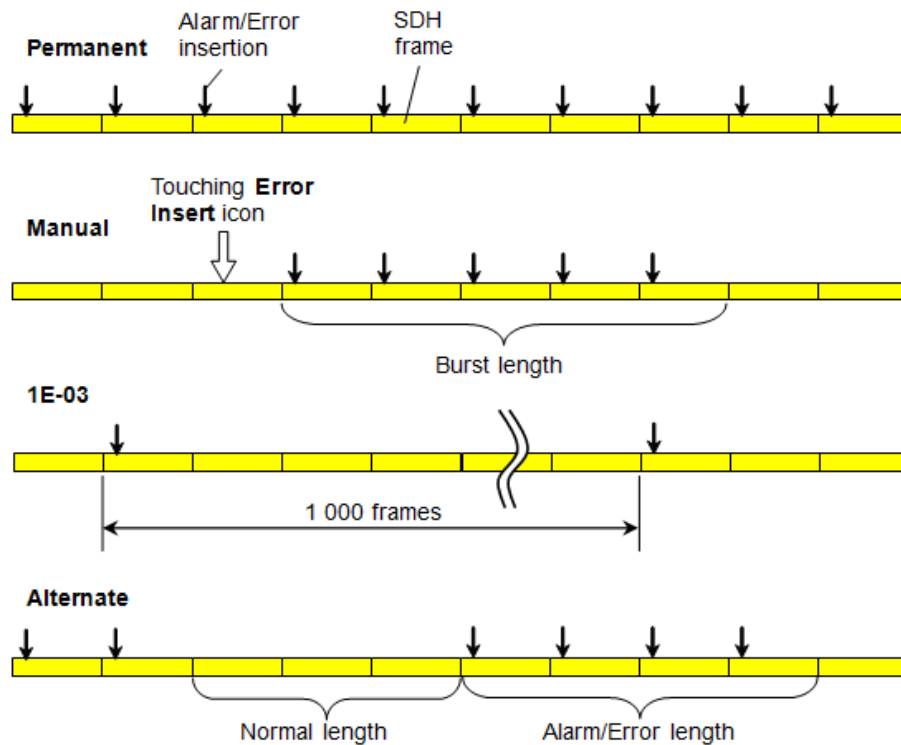

5.1.4.2 SDH frequency

Touch the field to set **Frequency Offset**. If setting a positive value, the frequency will shift higher side.

Example:

If setting -50 ppm to the frequency offset for STM-16 output signal, the bit rate of output signal will be

$$2\,488\,320 * (1 - 50 * 10^{-6}) = 2\,488\,195.584 \text{ (kbit/s).}$$

5.1.4.3 SDH pointer

1. Select **AU*** or **TU*** to insert the pointer.
2. Select the pointer type.
 - No test sequence: Does not insert pointers
 - Single alternating: Positive justification and negative justification
 - Regular + Double: Double positive justification
 - Regular + Missing: Negative justification
 - Double alternating: Double positive justification and double negative justification
3. Select the **Movement** or **Jump**.

Movement shifts the pointer value by specified value. **Jump** sets the specified value to the pointer.

4. Touch the field to set the pointer value. Then select one of followings.
 - Positive: Increases the pointer value.
 - Negative: Decreases the pointer value.
 - Incl. NDF: Sets NDF (New Data Flag) to enable ("1001").
 - Excl. NDF: Sets NDF to disable ("0110").
5. Touch the **Apply Movement** button or the **Apply Jump** button.

5.2 SONET Setup and Status

An OC-xx/STS-xx button in the navigation area of the [Ports Setup](#) screen gives you access to the SONET setup for the transmitter and/or receiver of the currently selected port.

Refer to [SDH/SONET switching](#) for switching to SONET.

Synchronous Optical Networking (SONET) refers to a standardized protocol that transfers digital signals over optical fiber using lasers. At low transmission rates data can also be transferred via an electrical interface.



The SONET interface uses the electrical BNC connectors and the optical ports.



MU100010A Connector Panel



Optical
(OC-3 to OC-192)

MU100011A Connector Panel

5.2.1 Transmitter Setup

5.2.1.1 Physical Setup

When the transmitter is set up with a SONET interface, selecting the Tx button in the navigation area will launch the following screen. (Note that the SONET Tx check box above the connector panel illustration is selected.)

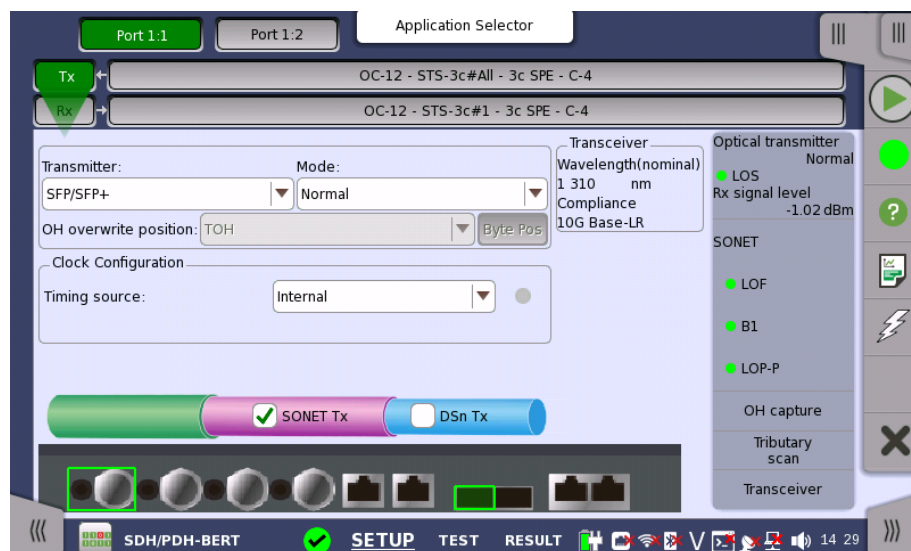

This screen allows you to enable the optical or electrical interface of the SONET transmitter. It can also be used to inspect the current status of the selected port.

The configuration options available in the setup area of the screen are described below. The status information is described in a separate section.

Transmitter

Use the **Transmitter** drop-down menus to select to the transmitter.

Mode

Use the **Mode** drop-down menus to select to the behavior of the transmitter.

OH overwrite position

Only enabled when the **OH overwrite** has been selected to the behavior of the transmitter. Use the drop-down menu to select the relevant overwrite position.

The available values are:

- TOH
- A1/A2 byte
- K1/K2 byte
- S1 byte
- DCC1-3 byte
- DCC4-12 byte
- J0 byte
- 1 byte of TOH

When '1 byte of TOH' is selected, touch the **Byte Pos** button to launch the **1 Byte of TOH** dialog box. Select the relevant byte in the dialog.

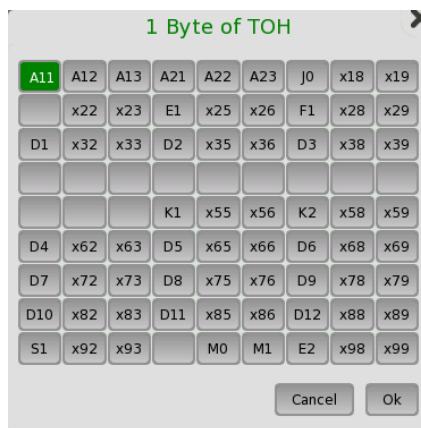

Clock Configuration

Use the drop-down menu to select the clock source. This is fixed to **Received** when the Port Mode is set to **Through** or **OH overwrite**.

Timing Source

Internal: Internal clock of the module

External: The clock input to the connector

Received: The clock generated from the received signal

When **External** or **Received** is set, the right hand lamp indicates whether clock is detected or not.

Transceiver Displays the Transceiver information when the option except "Electrical" is selected to the transmitter.

5.2.1.2 SONET Frame Setup

Touching the navigation area button which represents the transmitter's SONET layer will launch the following screen.

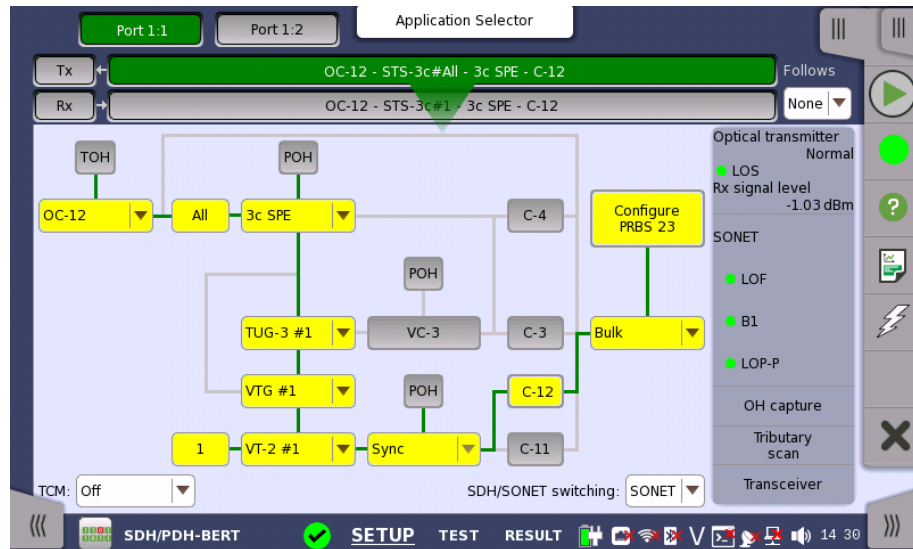

The general principle in setting up the SONET frame is to select the relevant values for the various containers in the multiplexing structure. This is done either via a drop-down menu or via a launched dialog box, by touching a drop-down menu or a button in the frame structure diagram.

Note that the currently 'active path' in the structure is highlighted. Note also that the changes you make will be reflected in the text displayed in the SONET button in the navigation area, if relevant.

Follows To make the Port 2 transmitter follow the Port 1 transmitter (i.e. copy its settings), touch the right-most button in the navigation area and select the **Tx1** in the drop-down menu. The Port 2 settings continue to follow the Port 1 transmitter change. The default setting is **None**. Note that the Port 1 transmitter cannot follow the Port 2 transmitter.

TCM Select the *TCM* (Tandem Connection Monitoring). The available TCM is decided by multiplex structure. If you select other TCM, the multiplex structure on the setup area will be changed.

The possible settings are:

- Off
- Z5 (STS-3c)
- Z5 (STS-1)
- Z6 (VT-2/1.5)

SDH/SONET switching Allows you to switch between SDH and SONET.

TOH Editor You can configure transport overhead (TOH) in a special dialog box (**TOH Editor**), which is launched when you touch the **TOH** button.

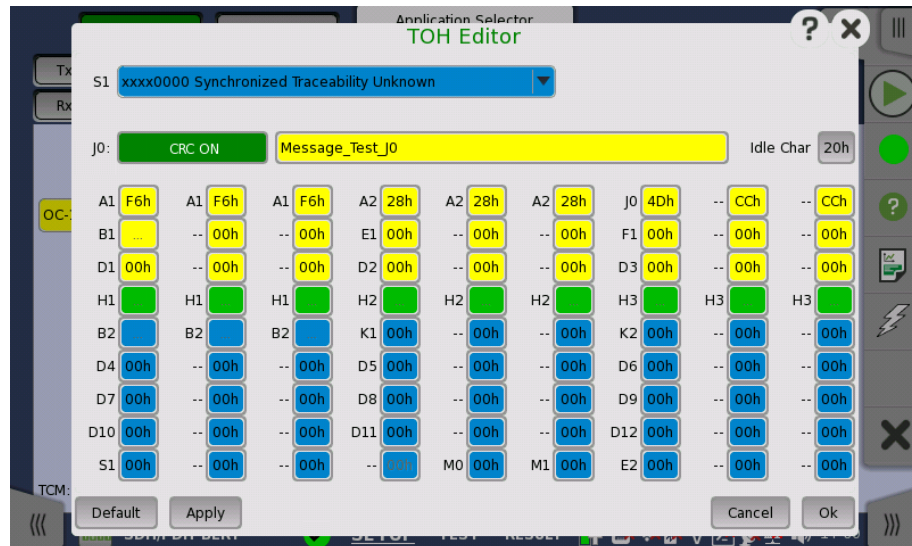

The setup principle is the same in this editor dialog box as in the SONET structure. Touching a button or opening a drop-down menu will open for new editor dialog boxes, new value selections etc.

- **S1:** Synchronization status
- **J0:** Regenerator section trace
Idle Char is an ASCII code used for the padding.
- **A1, A2:** Framing
Defined A1 as F6h (1111011b), A2 as 28h (00101000b).
- **B1:** BIP-8 (Bit Interleaved Parity) This byte cannot be set.
- **E1, E2:** Orderwire
E1 is part of the Section Overhead, E2 is part of the Line Overhead.
- **F1:** User channel
- **D1-D3:** Section data communication channel (DCC_R)
- **D4-D12:** Line data communication channel (DCC_M)
- **B2:** BIP-N×24 These bytes cannot be set.
- **K1, K2**(bit 1 to bit 5): Automatic protection switching (APS) channel
- **K2**(bit 6 to bit 8): RDI-L (Line Remote Defect Indication)
- **M0, M1:** REI-L (Line Remote Error Indication)
- **Z2:** Spare byte
- **H1, H2, H3:**STS pointer These bytes cannot be set.

This editor format is the same as TOH of OC-3/STS-3. For OC-12/48/192, TOH bytes in other column are filled with value set by the editor. In case of OC-12 TOH in following figure, you can edit A1A2 bytes in thicker lines cell. The bytes in gray cell are filled with the value in left side cell in thicker lines.

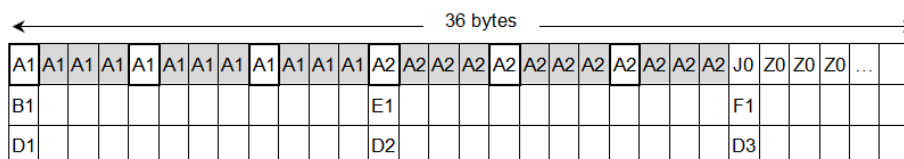

POH Editor

Touching a POH button launches the **STS-x POH Editor** or **VT-2/VT1.5 POH Editor** dialog box. The contents of the dialog depends on which path overhead you are configuring.

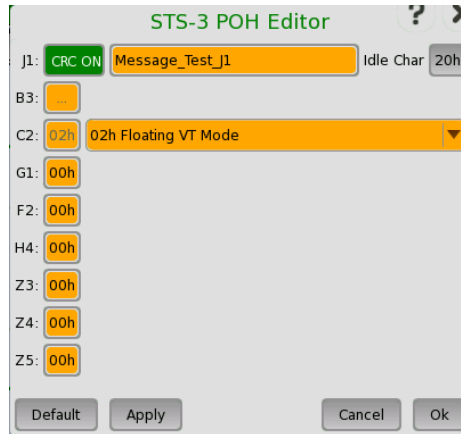

- **J1:** Path Trace
Idle Char is an ASCII code used for the padding.
- **B3:** Path BIP-8 This byte cannot be set.
- **C2:** Signal label
- **G1:** (bit 1 to 4) REI (bit 5) RDI (bit 6 and 7) Reserved (bit 8) Spare
- **F2,Z3:** Path user channels
- **H4:** Multiframe indicator
- **Z4:** (bit 1 to 4) Automatic protection switching (APS) channels (bit 5 and 6)
Spare (bit 7 and 8) Data link
- **Z5:** Network operator byte

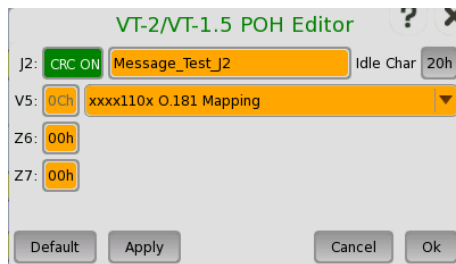

- **J2:** Path Trace
Idle Char is an ASCII code used for the padding.
- **V5:** (bit 1 and 2) BIP-2 (bit 3) REI (bit 4) RFI (bit 5 to 7) Signal label (bit 8) RDI
- **Z6:** Network operator byte
- **Z7:** (bit 1) Extended signal label (bit 2) Low order virtual concatenation (bit 3 and 4) Automatic protection switching (APS) channels (bit 5 to 7) Reserved (bit 8) Data link

Bulk Pattern

To set up the bulk pattern, touch the **Configure xxxxx** button to launch the **Bulk Pattern** dialog box.

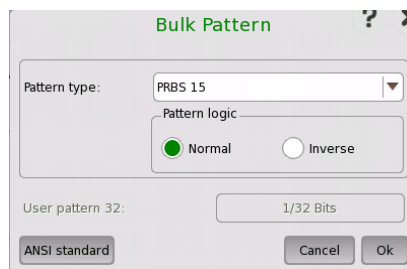

Pattern type

Select a predefined pattern or define a user pattern.

- **User [32] bit, User [2048] bit:** 32 bits or 2048 bits length pattern.
The field which shows bit length is enabled. Touch the field to launch the dialog box to define the bit pattern. Refer to [The User Pattern Editor](#).
- **PRBS9 to PRBS31:** Pseudo-random bit sequence. The number indicates the bit length of sequence.
For example, bit length of PRBS9 is $2^9-1=511$.
Pattern logic is enabled.
- **All 0's, All 1's:** All bits are 0, all bits are 1.
- **Alternating 1:1, Alternating 1:3, Alternating 1:7:** Bit pattern such as "010101...", "100010001000...", "1000000010000000..."
- **2 in 8:** Bit pattern such as "010000100100001001000010..."

ANSI Standard

Touching the 'ANSI standard' button will apply standard recommended **Pattern type** for currently selected SONET frame.

- C-4: PRBS 23 Inverse
- C-3 (STS-3c SPE): PRBS 23 Inverse
- C-3 (STS-1 SPE): PRBS 15 Inverse
- C-12: PRBS 15 Inverse
- C-11: PRBS 15 Inverse

5.2.2 Receiver Setup

5.2.2.1 Physical Setup

When the receiver is set up with a SONET interface, touching the **Rx** button in the navigation area will launch the following screen. (Note that the **SONET Rx** check box above the connector panel illustration is selected.)

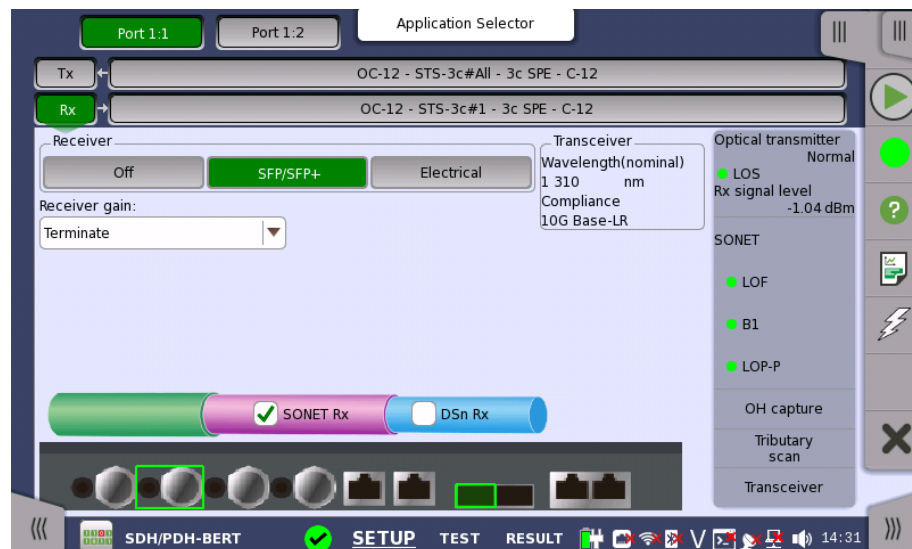

This screen allows you to make the physical setup of the receiver in SONET mode. It can also be used to inspect the current status of the selected port.

The configuration options available in the setup area of the screen are described below. The status information is described in a separate section.

Receiver

Touch the button corresponding to the relevant interface type.

- **Off:** No interface

- **SFP/SFP+**: Optical interface
- **Electrical**: Electrical interface (BNC connector)

Receiver gain Only relevant for electrical receivers. Select the attenuation and impedance mode from the drop-down menu.

- **Terminate**: Up to 12.7 dB cable attenuation, nominal impedance
- **Monitor**: 20 dB linear attenuation and up to 12 dB cable attenuation, nominal impedance.

Transceiver Displays the Transceiver information when Optical transmitter is selected.

5.2.2.2 SONET Frame Setup

Touching the navigation area button which represents the receiver's SONET layer will launch the following screen.

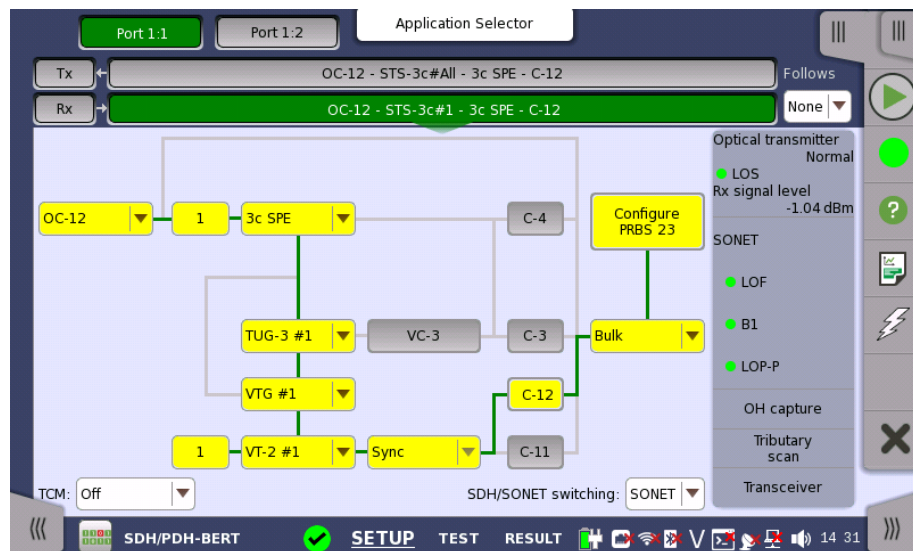

The manner of setting up the SONET interface of receiver is the same as that of transmitter. Refer to [SONET Frame Setup](#).

Follows To make the currently selected receiver follow either the transmitter or Port 1 receiver (i.e. copy its settings), touch the right-most button in the navigation area and select the relevant value in the drop-down menu. The receiver settings continue to follow the change of either the transmitter or Port 1 receiver. The default setting is **None**. Note that the Port 1 receiver cannot follow the Port 2 receiver.

TCM Select the *TCM* (Tandem Connection Monitoring). The available TCM is decided by multiplex structure. If you select other TCM, the multiplex structure on the setup area will be changed.

The possible settings are:

- Off
- Z5 (STS-3c)
- Z5 (STS-1)
- Z6 (VT-2/1.5)

SDH/SONET switching Allows you to switch between SDH and SONET.

5.2.3 Status Information

This section describes the status information available for the SONET layer in the status area of the **Ports Setup** screen.

5.2.3.1 Status Summary

The status summary displayed for the SONET layer consists of the following information:

Physical Status

The topmost part of the status area gives you access to information about the current physical status of the selected interface. A summary consisting of the most relevant status indicators is displayed constantly. By touching the summary, you can launch a display that contains the detailed status information.

Alarm/Error Status

The middle part of the status area gives you access to alarm and error information for the selected interface. The status is indicated by the lamp color. A summary consisting of the most relevant alarm/error indications is displayed constantly. By touching the summary, you can launch a display that contains all alarms/errors.

Capture/Monitor Status

At the bottom of the status area are below buttons that give you access to various capture/monitor information. By touching a button, you can launch the corresponding information display.

- OH capture
- Tributary scan
- Transceiver

5.2.3.2 Physical Details

Refer to [Physical Details](#) in "SDH Setup and Status".

5.2.3.3 Alarms and Errors

Touching the middle summary box in the status area of the **Ports Setup** screen allows you to launch the dialog box shown below.

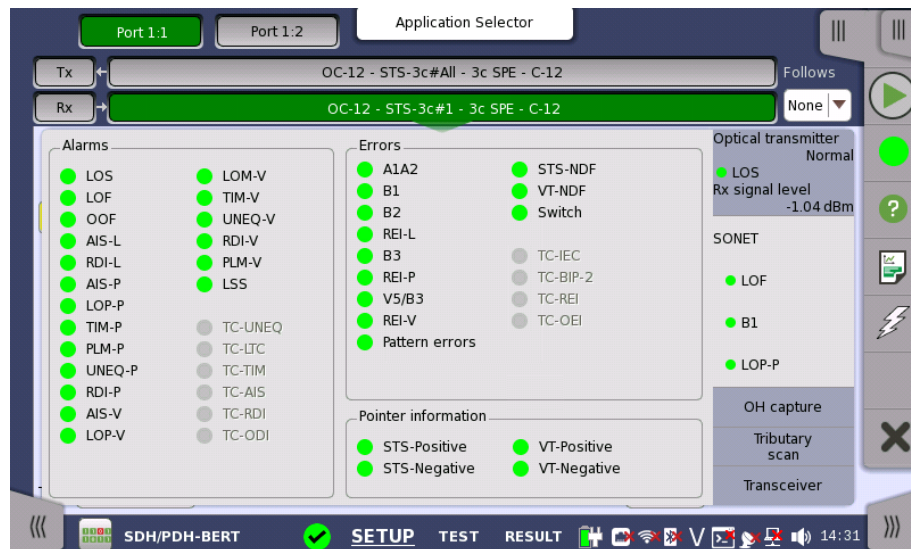

This dialog box contains detailed alarm and error information related to the SONEt interface. Status is indicated by the use of [colored Lamp icons](#).

Alarms

- **LOS**: Loss of Signal
- **LOF**: Loss of Frame
- **OOF**: Out of Frame
- **AIS-L**: Line Alarm Indication Signal
- **RDI-L**: Line Remote Defect Indication
- **AIS-P**: Path Alarm Indication Signal
- **LOP-P**: Path Loss of pointer
- **TIM-P**: Path Trace Identifier Mismatch
- **PLM-P**: Path Payload Mismatch
- **UNIQ-P**: Path UNEQuipped
- **RDI-P**: Path Remote Defect Indication
- **AIS-V**: VT-Path Alarm Indication Signal
- **LOP-V**: VT-Path Loss of pointer
- **LOM-V**: VT-Path Loss of Multiframe
- **TIM-V**: VT-Path Trace Identifier Mismatch
- **UNIQ-V**: VT-Path UNEQuipped
- **RDI-V**: VT-Path Remote Defect Indication
- **PLM-V**: VT-Path Payload Mismatch
- **LSS**: Loss of Sequence Synchronization
- **TC-UNEQ**: Tandem Connection UNEQuipped
- **TC-LTC**: Tandem Connection Loss of Tandem Connection
- **TC-TIM**: Tandem Connection Trace Identifier Mismatch
- **TC-AIS**: Tandem Connection Alarm Indication Signal
- **TC-RDI**: Tandem Connection Remote Defect Indication
- **TC-ODI**: Tandem Connection Outgoing Defect Indication

Errors

- **A1A2**: Bytes used for the frame synchronization
- **B1**: The byte of BIP-8 (Bit Interleaved Parity-8)
- **B2**: The bytes of 24 parity bits
- **REI-L**: Line Remote Error Indication
- **B3**: The byte of BIP-8 (Bit Interleaved Parity-8)

- **REI-P** : Path Remote Error Indication
- **V5/B3**: BIP-2 of VT-2/VT-1.5 or BIP-8 of Low order VC-3
- **REI-V**: VT-Path Remote Error Indication
- **Pattern errors**: Bit error detected in the payload
- **STS-NDF**: Path New Data Flag
- **VT-NDF**: VT-Path New Data Flag
- **Switch** : APS switching occurred
- **TC-IEC**: Tandem Connection Incoming Error Count
- **TC-BIP-2**: Tandem Connection Bit Interleaved Parity-2
- **TC-REI**: Tandem Connection Remote Error Indication
- **TC-OEI** :Tandem Connection Outgoing Error Indication

Pointer information

- **STS-Positive**: Synchronous Transport Signal Positive stuffing
- **STS-Negative**: Synchronous Transport Signal Negative stuffing
- **VT-Positive**: Virtual Tributary Positive stuffing
- **VT-Negative**: Virtual Tributary Negative stuffing

5.2.3.4 OH Capture

Refer to [OH Capture](#) in "SDH Setup and Status".

5.2.3.5 Tributary Scan

Refer to [Tributary Scan](#) in "SDH Setup and Status".

5.2.3.6 Transceiver

Refer to [Transceiver](#) in "SDH Setup and Status".

5.2.4 Errors/Alarms Insertion

Refer to [Errors/Alarms Insertion](#) in SDH Setup and Status sub section.

5.3 E1 Setup and Status

E1 represents the 2.048 Mbit/s PDH layer. The [Ports Setup](#) screen gives you access to the PDH layer setup for the transmitter and/or receiver of the currently selected port.

Plesiochronous Digital Hierarchy (PDH) refers to the technology originally used in telecommunications networks to transport data over digital transport equipment such as fiber optic systems.

E1 allows transmission of data streams that are nominally running at the same rate, however allowing for some variation in the speed around a nominal rate (+/-125 ppm variation around 2 Mbit/s).

The E1 frame has 32 time slots during $125\ \mu\text{s}$, and one time slot contains eight bits. The time slot 0 is used for multi frame.

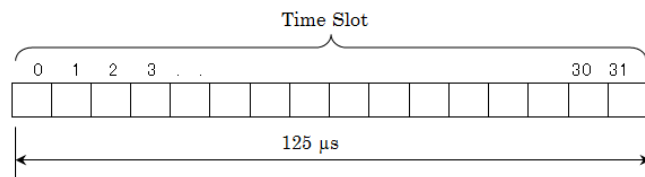

E1 Frame structure



The E1 interface uses the electrical BNC connectors (unbalanced) or the electrical RJ48 connectors (balanced).

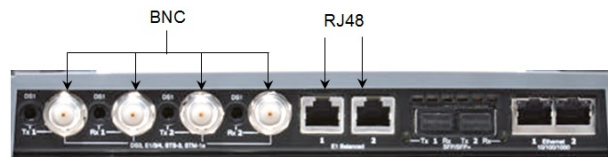

MU100010A Connector Panel

5.3.1 Transmitter Setup

5.3.1.1 Physical Setup

When the transmitter is set up with only an E1 interface, touching the **Tx** button in the navigation area will launch the following screen.



Switching between PDH Tx and DS_n Tx is done in the SDH/SONET transmitter setup screen.

1. Select **SDH Tx** or **SONET Tx** check box.
2. Touch **STM-xx**, **STS-xx**, or **OC-xx** button in the navigation area.
3. Use drop down menu at right bottom to switch SDH or SONET. Selecting the SDH displays **PDH Tx** on Tx screen. Selecting the SONET displays **DS_n Tx** on Tx screen.
4. Touch **Tx** button in the navigation area.
5. Select **PDH Tx** or **DS_n Tx** check box.
6. Clear **SDH Tx** or **SONET Tx** check box.
7. Touch **E1** radio button. Touching **Off** radio button disables the transmitter.

This screen allows you to make the physical setup of the PDH transmitter in E1 mode. It can also be used to inspect the current status of the selected port.

The configuration options available in the setup area of the screen are described below. The status information is described in a separate section.

Connector

Select the type of the input/output connectors of the instrument. Choose **Unbalanced** to link to the corresponding unbalanced connector, or choose **Balanced** to link to the corresponding balanced connector. A balanced output goes to the RJ48 connector.

Pin assignment of E1 Balanced Connectors

RJ-48 Pin	Signal
	1 RX, Ring
	2 RX, Tip
	3 Ground
	4 TX, Ring
	5 TX, Tip
	6 Ground
	7 No connect
	8 No connect

Be sure to confirm the cable type. For E1 cable, there are the straight cable and the cross cable.

Drop and insert Select the source for the transmitter.
On: transmits the received data which the data generated in the Network Master has added.
Off: transmits the data generated in the Network Master.

Timing Source Select the clock source.

- Internal:** Internal clock of the module
- External:** The clock provided from the Ext Clock connector
- Received:** The clock generated from the received signal

When **External** or **Received** is set, the right hand lamp indicates whether clock is detected or not.

5.3.1.2 E1 Signal Setup

Touching the navigation area button which represents the transmitter's E1 layer will display the screen.

Follows To make the Port 2 transmitter follow the Port 1 transmitter (i.e. copy its settings) when using Port 1 and Port 2, touch the drop-down menu in the navigation area and select the **Tx1**. The Port 2 settings continue to follow the Port 1 transmitter change. The default setting is **None**. Note that the Port 1 transmitter cannot follow the Port 2 transmitter.

Frame tab page

The **Frame** tab page contains the following parameters:

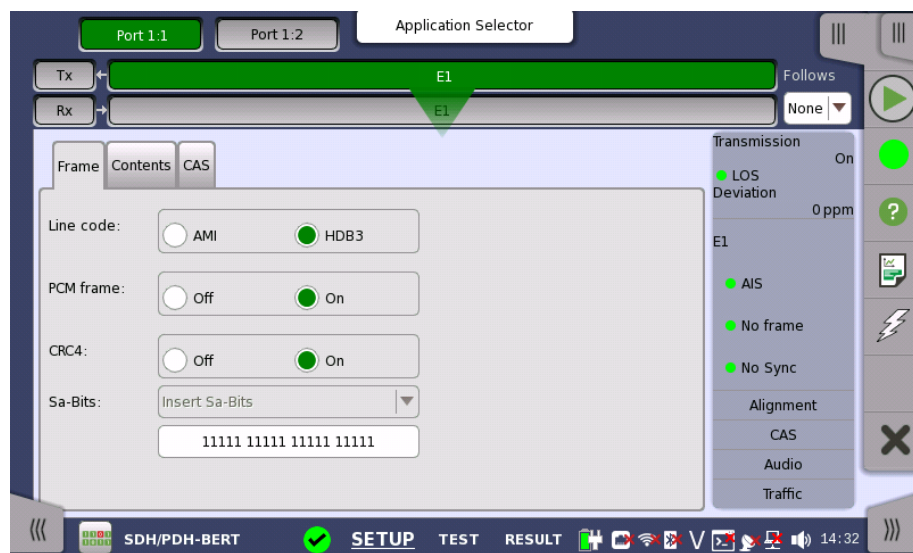

Line code

Use the **Line code** radio buttons to select transmission line code.

- **HDB3:** High-Density Bipolar Order 3
- **AMI:** Alternate Mark Inversion

PCM frame

Use the **PCM frame** radio buttons to enable (**On**) or disable (**Off**) insertion of PCM frame in the transmitted signal.

PCM frame is formed by 16 E1 frames. Frame structure is shown below.

Frame number	Bits 1 to 8 of the frame (Timeslot 0)							
	1	2	3	4	5	6	7	8
0	C1	0	0	1	1	0	1	1
1	0	1	A	Sa	Sa	Sa	Sa	Sa
2	C2	0	0	1	1	0	1	1
3	0	1	A	Sa	Sa	Sa	Sa	Sa
4	C3	0	0	1	1	0	1	1
5	1	1	A	Sa	Sa	Sa	Sa	Sa
6	C4	0	0	1	1	0	1	1
7	0	1	A	Sa	Sa	Sa	Sa	Sa
8	C1	0	0	1	1	0	1	1
9	1	1	A	Sa	Sa	Sa	Sa	Sa
10	C2	0	0	1	1	0	1	1
11	1	1	A	Sa	Sa	Sa	Sa	Sa
12	C3	0	0	1	1	0	1	1
13	E	1	A	Sa	Sa	Sa	Sa	Sa
14	C4	0	0	1	1	0	1	1
15	E	1	A	Sa	Sa	Sa	Sa	Sa

Sub multiframe (SMF) I: Frame number 0 to 7, II: Frame number 8 to 15
E: CRC4 error indication bits (FEBE)
Sa: Spare bits
C1 to C4: Cyclic Redundancy Check-4 (CRC4) bits
A: Remote Alarm Indication (RAI)



When PCM frame is set to Off, many of the following transmitter parameters are insignificant.

CRC4

Use the **CRC4** radio buttons to enable (**On**) or disable (**Off**) CRC4 in the transmitted signal contained in the PCM Frame.



If you are uncertain whether the CRC4 should be selected or not, it is recommended to enable the CRC4.



*If **Drop and Insert** of the total contents of a receiver is selected and the signal contains CRC4, it is possible to either Bypass or Insert Sa-Bits.*

Sa-Bits

Use the drop-down menu above the setup field to select whether or not to **Insert Sa-Bits** or **Bypass Sa-Bits** (this is only relevant when **Drop and insert** is set to **On**).

You can set the Sa-Bits value of the non-FAS words in the transmitted signal when containing PCM Frame/CRC4. Touch the **Sa-Bits** setup field to open the setup dialog box.

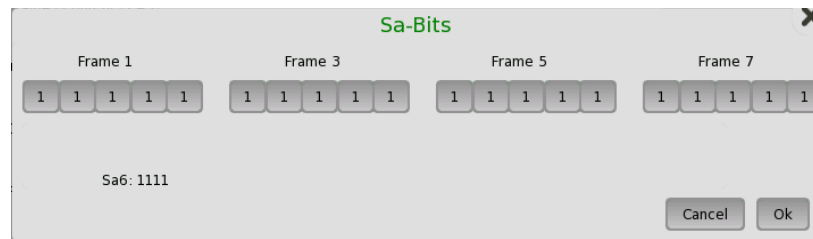

In the **Sa-Bits** dialog box, change the individual Sa-bits by touching on the relevant bit keys - this will toggle the bit key's binary value from logic 1 to 0 or vice versa. Touch **Ok** to accept the changes and close the dialog.

Content tab page

The **Content** tab page contains the following parameters:

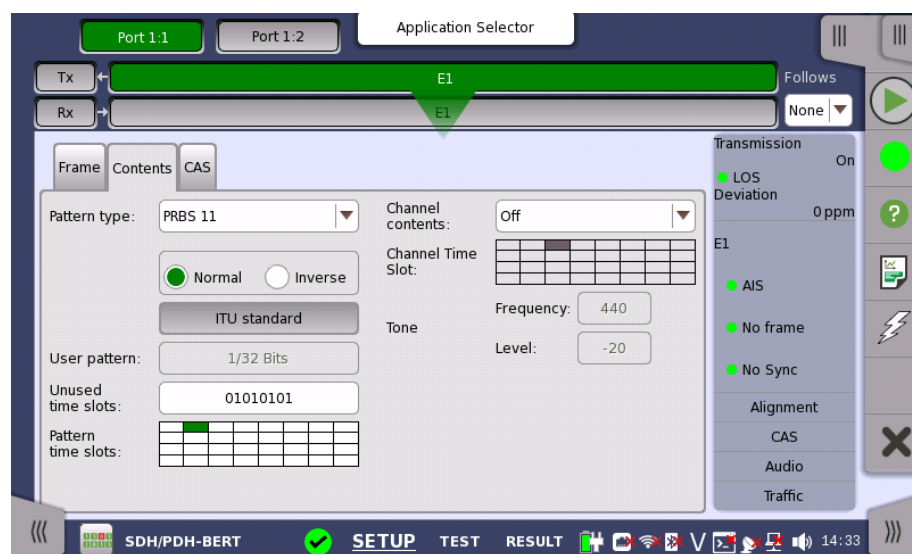

Pattern type

Select the pattern to be inserted in the transmitted signal.

- **Off**: Does not insert the pattern.
- **User [32] bit, User [2048] bit**: 32 bits or 2048 bits length pattern.
- **PRBS 11 to PRBS 23**: Pseudo-random bit sequence. The number indicates the bit length of sequence.

For example, bit length of PRBS 9 is $2^9-1=511$.

Pattern Logic is enabled.

- **QRSS 11, QRSS 20**: Quasi-random signal source.
The bit length of QRSS 11 is 2047, the length of QRSS 20 is 1 048 575.
- **Fox Pattern** 'THE QUICK BROWN FOX JUMPS OVER THE LAZY DOG 1234567890' in ASCII code
- **Fox (CMA3000)** The 'fox pattern' using for the combined test with CMA3000 (the previous model of Network Master)
- **All 0's, All 1's**: All bits are 0, all bits are 1.
- **Alternating 1:1**: Bit pattern such as "010101..."
- **Alternating 1:3**: Bit pattern such as "100010001000..."
- **Alternating 1:7**: Bit pattern such as "1000000010000000..."
- **Alternating 3:24**: A repeating 24-bit sequence that contains three ones, fifteen consecutive zeros and 12.5% average ones density.

You can select 'Normal' or 'Inverse' pattern type.

Touching the 'ITU standard' button will apply ITU-T O.150 recommended **Pattern type** for N x 64 kbps data rates (PRBS 11).

User pattern

User pattern field is enabled if Pattern type is set to **User [32] bit** or **User [2084] bit**. Touch the **User pattern** field and use the launched **Pattern Editor** dialog box to define the user pattern. Depending on the selected pattern type, different user pattern setup options will be available.

The length can be any length from 1 bit to 32 bits or from 1 bit to 2048 bits.

Unused time slots

Touch the **Unused time slots** field and use the launched dialog box to define the unused time slots.

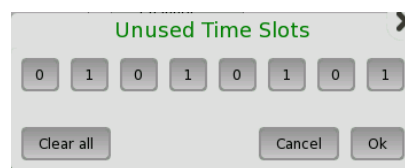

In the **Unused time slots** dialog box, change the individual bits by touching on the relevant bit keys - this will toggle the bit key's binary value from logic 1 to 0 or vice versa. Touch **Ok** to accept the changes and close the dialog box.

Pattern time slots

Touch the **Pattern time slot** graphics and use the dialog box to select the timeslots in which the Pattern will be inserted. Set and clear timeslots as relevant.

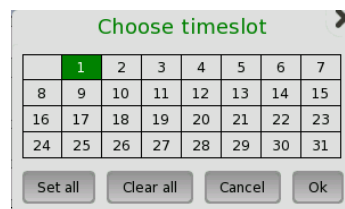

Channel contents

Use the **Channel contents** drop-down menu to select the signal transmitting into the timeslot:

- **Off**: No channel content is selected.
- **Tone**: Tone with specified frequency and level.
- **Transparent**: Received content in the same channel time slot is used.
- **Speech**: Pre-programmed speech sequence. 'Drop and insert' on Tx screen will be switched to On.

Channel Time Slot

Touch the **Channel Time Slot** graphics and use the dialog box to select the channel timeslot. If Speech or Tone is selected audio is inserted in selected timeslot. If Transparent is selected, the destination for transparent errors is selected.

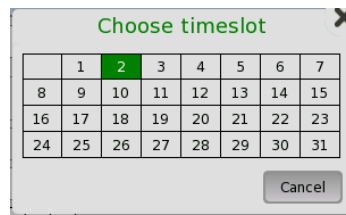

Tone

Touch the **Tone Frequency** button and use the launched dialog box to key in the frequency, using the numeric soft keys.

Touch the **Level** button and use the launched dialog box to key in the level.

CAS tab page

The **CAS** tab page contains the following parameters:

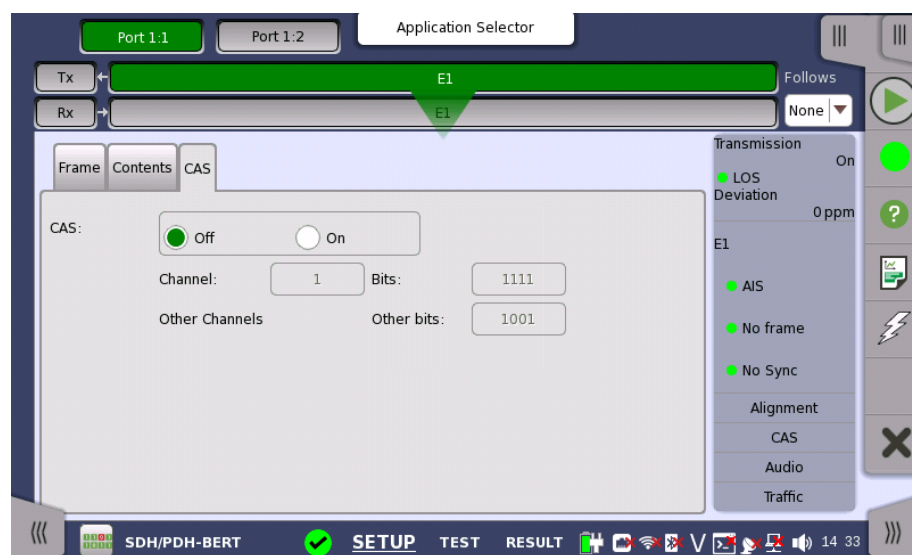

CAS

Use the **CAS** radio buttons to enable (**On**) or disable (**Off**) the insertion of a CAS (Channel Associated Signaling) signaling multiframe into time slot 30 of the transmitted signal.

Touch the **Channel**, **Bits** and **Other bits** fields to define the contents of a selectable CAS channel as well as the remaining channels.

5.3.2 Receiver Setup

5.3.2.1 Physical Setup

When the receiver is set up with only an E1 interface, selecting the **Rx** button in the navigation area will launch the following screen.



Switching between PDH Rx and DS_n Rx is done in the SDH/SONET receiver setup screen.

1. Select **SDH Rx** or **SONET Rx** check box.
2. Touch **STM-xx**, **STS-xx**, or **OC-xx** button in the navigation area.
3. Use drop down menu at right bottom to switch SDH or SONET. Selecting the SDH displays **PDH Rx** on **Rx** screen. Selecting the SONET displays **DS_n Rx** on **Rx** screen.
4. Touch **Rx** button in the navigation area.
5. Select **PDH Rx** or **DS_n Rx** check box.
6. Clear **SDH Rx** or **SONET Rx** check box.
7. Touch **E1** radio button. Touching **Off** radio button disables the receiver.

This screen allows you to make the physical setup of the PDH receiver in E1 mode. It can also be used to inspect the current status of the selected port.

The configuration options available in the setup area of the screen are described below. The status information is described in a separate section.

Connector

Select the physical type of the relevant output connectors located on the back panel of the instrument. Choose **Unbalanced** to link to the corresponding unbalanced connector, or choose **Balanced** to link to the corresponding balanced connector. A balanced input is taken from RJ48 connector.

Pin assignment of E1 Balanced Connectors

RJ-48 Pin	Signal
	1 RX, Ring
	2 RX, Tip
	3 Ground
	4 TX, Ring
	5 TX, Tip
	6 Ground
	7 No connect
	8 No connect

Be sure to confirm the cable type. For E1 cable, there are the straight cable and the cross cable.

Input mode

Select the mode of input.

Terminate

Used when the instrument is used as a tester and the receiver is the only device connected to the line. The input impedance is nominal.

Bridged

Used when the receiver is connected directly in parallel to a line carrying live traffic. Please observe that this way of connecting may disturb the monitored line - connection through a protected monitor point, as well as using the input mode **Monitor**, is recommended instead.

Monitor

Used when connecting to protected monitoring points. The input impedance is nominal.

Input sensitivity

Set the sensitivity of the input. The available options are:

Full sensitivity

Signal levels down to the maximum sensitivity on the instrument are accepted.

-20 dB

Input signal attenuated by -20 dB or more relative to the nominal level will be considered Loss Of Signal.

-33 dB

Input signal attenuated by -33 dB or more relative to the nominal level will be considered Loss Of Signal.

5.3.2.2 E1 Signal Setup

Touching the navigation area button which represents the receiver's E1 layer will display the screen.

Follows

To make the currently selected receiver follow either the transmitter or Port 1 receiver (i.e. copy its settings), touch the drop-down menu in the navigation area and select the relevant value. The receiver settings continue to follow the change of either the transmitter or Port 1 receiver. The default setting is **None**. Note that the Port 1 receiver cannot follow the Port 2 receiver.

Frame tab page

The **Frame** tab page contains the following parameters:

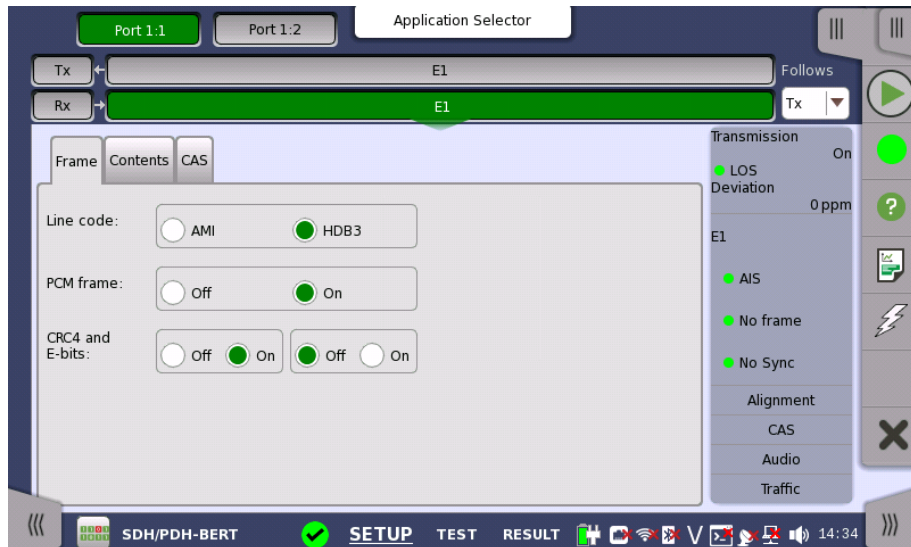

Line code

Use the **Line code** radio buttons to select transmission line code **HDB3** or **AMI**.



For normal 2 Mbps systems choose HDB3. AMI is for special applications only.

PCM frame

Use the **PCM frame** radio buttons to enable (**On**) or disable (**Off**) the status of the PCM frame.

CRC4 and E-bits

Use the **CRC4 and E-bits** radio buttons to enable (**On**) or disable (**Off**) the corresponding bit in the received signal. Use buttons in left frame for setting CRC4. Use buttons in right frame for setting E-Bit.



*If it is uncertain whether the **CRC4 and E-bits** are supported in the monitor signal, it is recommended to select the **Off** mode.*

Content tab page

The **Content** tab page contains the following parameters:

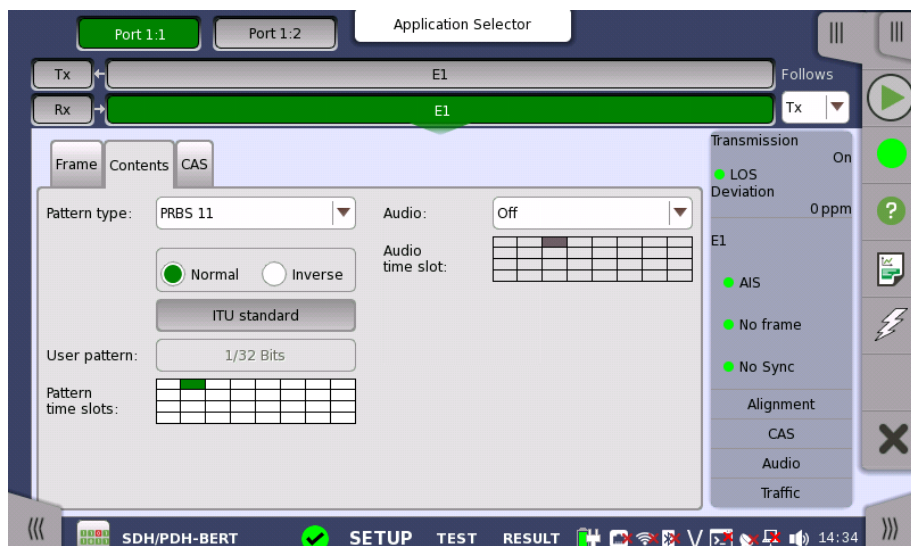

Pattern type

Select the requested pattern. Refer to [Pattern type](#) in "Transmitter Setup".



For testing of data rates from 64 kbps to 2 Mbps in a 2 Mbps line, ITU-T O.150 recommends PBRBS 11 to be used. For testing at the 2 Mbps rate, PRBS 15 is recommended in ITU-T O.150.

Select 'Normal' or 'Inverse' pattern type.

Touching the 'ITU standard' button will apply ITU-T O.150 recommended **Pattern type** for N x 64 kbps data rates (PRBS 11).

User pattern

User pattern field is enabled if Pattern type is set to **User [32] bit** or **User [2084] bit**. Touch the **User pattern** field and use the launched **Pattern Editor** dialog box to define the user pattern. Depending on the selected pattern type, different user pattern setup options will be available.

The length can be any length from 1 bit to 32 bits or from 1 bit to 2048 bits.

Pattern time slots

Touch the **Pattern time slots** graphics and use the launched dialog box to select the timeslot which will receive the Channel Content signal. Set and clear timeslots as relevant.

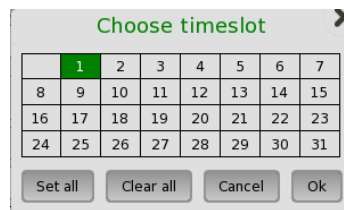

Audio

Use the **Audio** drop-down menu and select the features for the receiver decoding. Select **On** to enable the audio decoding or **Off** to disable.

Audio Time Slot

Touch the **Audio Time Slot** graphics and use the launched dialog box to select the timeslot.

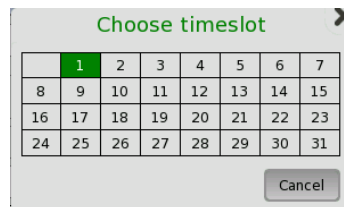

CAS tab page

The **CAS** tab page contains the following parameters:

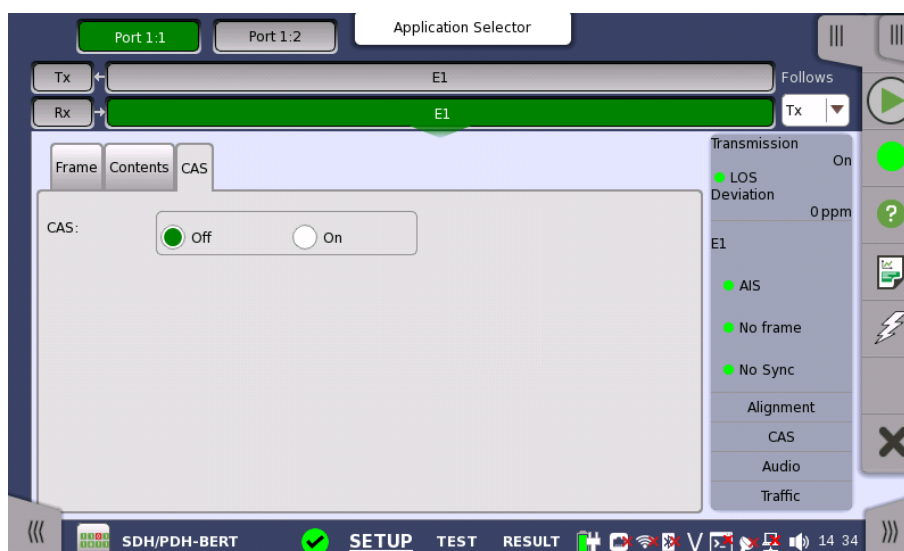

CAS

Use the **CAS** radio buttons to enable (**On**) or disable (**Off**) the reception of a CAS (Channel Associated Signaling) signaling multiframe in time slot 16 of the received signal.

5.3.3 Status Information

This section describes the status information available for the E1 layer in the status area of the **Ports Setup** screen.

5.3.3.1 Status Summary

The status summary displayed for the E1 layer consists of the following information:

Physical Status

The topmost part of the status area gives you access to information about the current physical status of the selected interface. A summary consisting of the most relevant status indicators is displayed constantly. By touching the summary, you can launch a display that contains the detailed status information.

Alarm/Error Status

The middle part of the status area gives you access to alarm and error information for the selected interface. The current status is indicated by the lamp color.

A summary consisting of the most relevant alarm/error indications is displayed constantly. By touching the summary, you can launch a display that contains all alarms/errors.

Monitor Buttons

At the bottom of the status area are below buttons that give you access to various monitor information. By touching a button, you can launch the corresponding information display.

- Alignment
- CAS
- Audio
- Traffic

5.3.3.2 Physical Details

Touching the topmost summary box in the status area of the **Ports Setup** screen displays the status shown below.



This screen presents detailed information about the current physical status of the received signal at the 2 Mbps E1 layer.

The physical status information consists of the following parameters.

Signal level

The Signal Level indicators show the attenuations (in dB) of the currently received signals compared to a nominal signal.

The nature of the levels depend on the Input Level setup for each receiver (Terminate or Monitor):

- In Terminate mode, the attenuation is assumed to be caused by a cable.
- In Monitor mode, linear attenuation is assumed.

Deviation

The deviation from the nominal bit rate is shown for each receiver in both ppm and bps. The nominal bit rate is 2 048 000 bps.

Bit rate

The actual bit rate of each receiver is shown (in bps).

Pattern Bit rate

This field shows the effective bit rate of the patterns received (that is, the number of pattern bits received per second).

5.3.3.3 Alarms and Errors

Touching the middle summary box in the status area of the **Ports Setup** screen displays the status shown below.

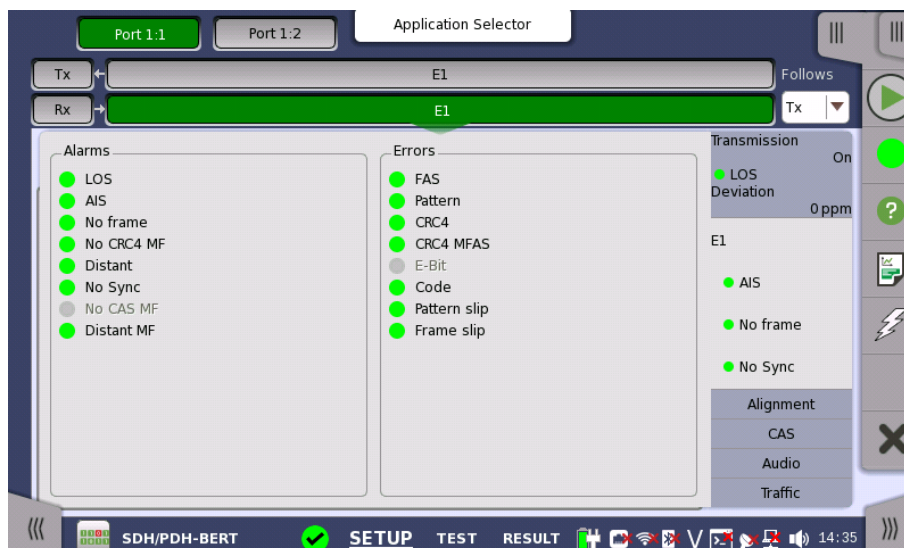

This screen contains detailed alarm and error information related to the E1 interface. Status is indicated by the use of [colored Lamp icons](#).

Alarms

- **LOS**: Loss of Signal
- **AIS**: Alarm Indication Signal
- **No frame**: No Frame
- **No CRC4 MF**: No Cyclic Redundancy Check 4 Multi Frames
- **Distant**: Distant
- **No Sync**: No Synchronization
- **No CAS MF**: No Channel-Associated Signaling Multi Frames
- **Distant MF**: Distant Multi Frames

Errors

- **FAS**: Frame Alignment Signal
- **Pattern**: Pattern
- **CRC4**: Cyclic Redundancy Check 4
- **CRC4 MFAS**: Cyclic Redundancy Check 4 Multiplex Frame Alignment Signal
- **E-Bit**: E-Bit Error
- **Code** : Code
- **Pattern slip** : Pattern slip
- **Frame slip** : Frame slip

5.3.3.4 Alignment

Touching the **Alignment** button in the status area of the **Ports Setup** screen displays the status shown below.



This screen provides information on the frame alignment when available. The frame alignment information includes the 16 first FAS/NFAS words of the CRC4 multiframe.

If multiframe is not available, the frame information will show 16 FAS/NFAS words in sequence.

The following color indicators are used:

- Green: Cyclic Redundancy Check bits
- Orange: Bits used to indicate received faulty sub-multiframes
- Purple: Remote alarm indication
- Yellow: Spare bits reserved for national use.

5.3.3.5 CAS

Touching the **CAS** button in the status area of the **Ports Setup** screen displays the status shown below.

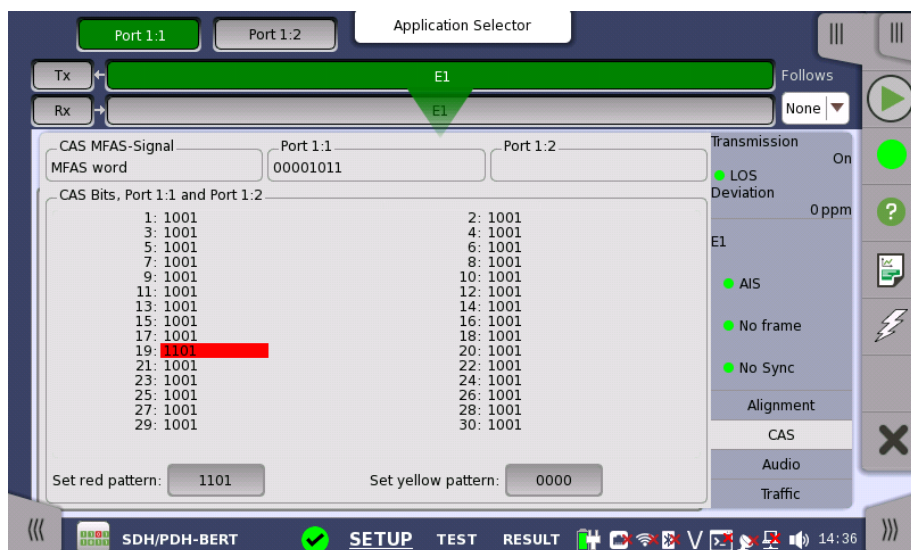

This screen gives information on the CAS (Channel Associated Signaling) signaling when available. It displays the state of the four signaling bits in both directions for all 30 channels. Activity is indicated with bold characters.

CAS MFAS-Signal

This field shows the status of the CAS MFAS-Signal.

Port1, Port2

This field shows the MFAS bits.

CAS Bits, Port1 and Port2

This table shows the status of the CAS Bits in the two ports.

Use of colors

For easy recognition of special bit combinations, coloring is available. Use the **Set red pattern** and **Set yellow pattern** buttons to launch the respective setup dialog boxes.

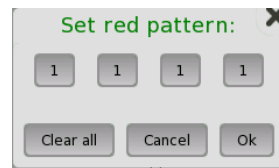

The color pattern consists of four binary digits. The minimum and the maximum acceptable value is 0000 and 1111, respectively. Touch the digit buttons to set the relevant value and then touch **Ok**.

To clear the whole word e.g. to make the line ready for new digit settings, touch the **Clear all** button.

5.3.3.6 Audio

Touching the **Audio** button in the status area of the **Ports Setup** screen launches the status shown below.

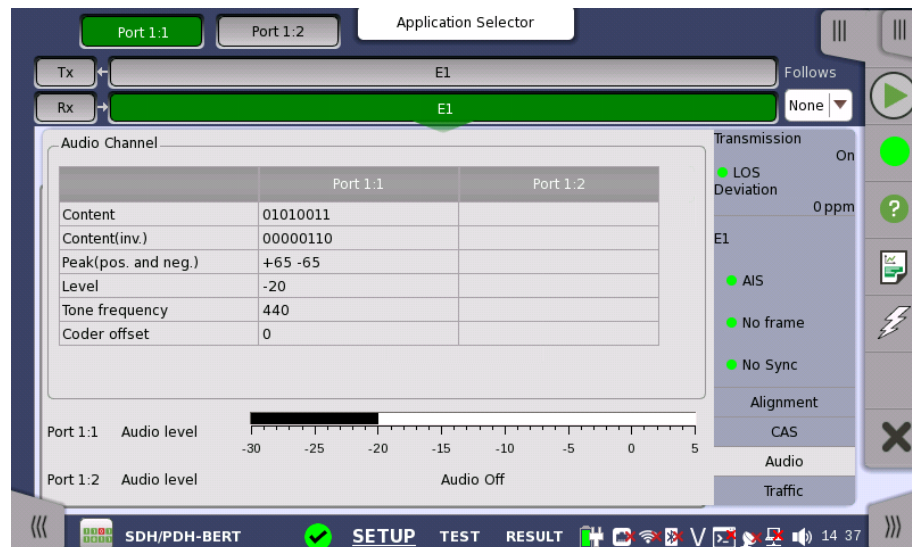

This dialog box provides information about audio channels.

Audio Channel**Content**

The received line content. For sub-rates this field shows the content of the subchannel.

The received line content with even bits inverted. With A-law coded speech it is possible to observe the A-law code words before the even bit inverting.



DS1/J1 inverts all the bits.

Peak (pos. and neg.)

The peak value of the signal. This only applies for A-law speech and it represents the largest received A-law coded value.

Level

The level of the audio signal is shown here.

Tone frequency

The frequency of the audio signal is shown here.

Coder offset

The coder offset is presented if the time slot displayed is a normal 64 kbit/s time slot.

Audio level

Two dBm meters show the volume of the currently selected audio channel (Port1 - Port2).

5.3.3.7 Traffic

Touching the **Traffic** button in the status area of the **Ports Setup** screen displays the status shown below.

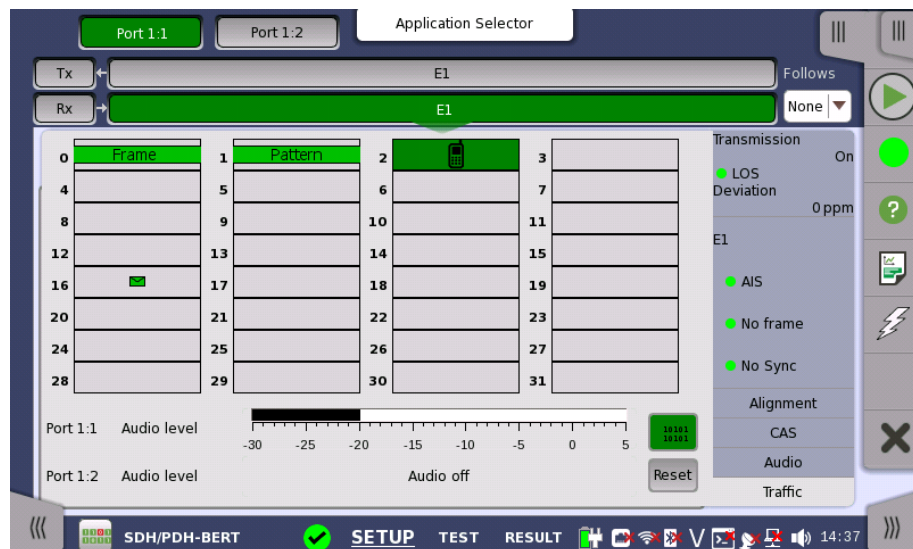

This screen shows the activity of the speech channels represented on the 2 Mbps line. You can switch between a traffic display and a view of the time slot content.

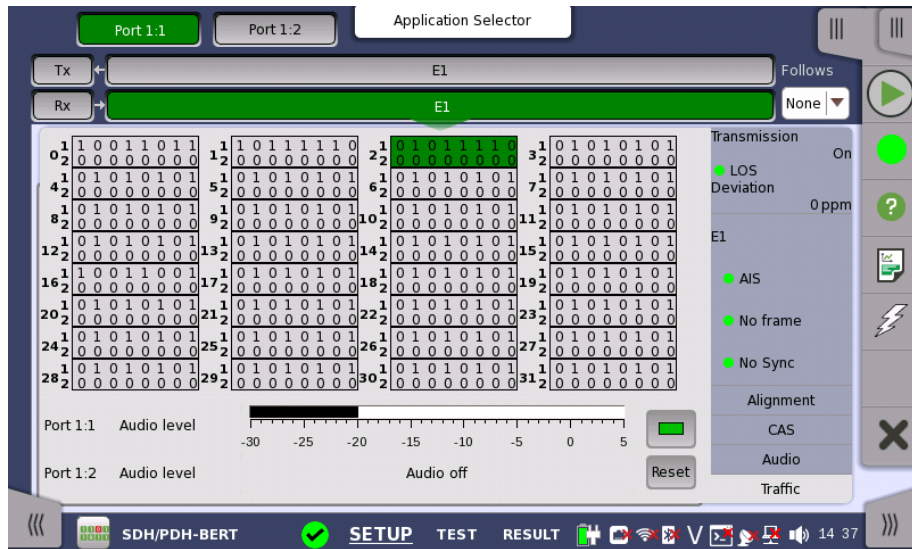

The busy / idle status of channel is displayed.

The current audio time slot is marked with an green highlighting. Select the relevant channel by touching it.



Audio Time Slots for all ports are marked, but it is only possible to change the time slots of the current port.



Touching this button will convert the table to display time slot content.



Touching this button will convert the graphic to display traffic.

Icon	PCM description
	Flags detected in currently selected signaling channel
	Channel activity

Touching **Reset** button will clear icons.

Audio level

Two dBm meters show the volume of the currently selected audio channel (Port1 - Port2).

5.3.4 Errors/Alarms Insertion

This section describes the errors or alarms insertion for the PDH layer on the [Application toolbar](#).



Alarms/Errors/ Others

Select the port to insert errors, and the stimuli type. The settings items vary depending on the selected stimulus type.

- **PDH Alarm/Errors:** Inserts errors or alarms related the PDH multi frame or the pattern error.
- **PDH frequency:** Adds the frequency offset to the PDH bit rate.

5.3.4.1 PDH Alarms/Errors

1. Select **Error insertion** or **Alarm** using the drop down menu.
Alarm will be inserted continuously.
 - **No error:** Turns off inserting Alarms or Errors.
 - **Manual:** Inserts errors in the specified counts if you touch the Error Insert icon.
 - **Burst*1E-03 to Burst*1E-07:** Inserts errors of burst length in the specified rate continuously. For example, **Error burst length** is set to 5 and **Burst*1E-06** is selected, the errors will be inserted in five straight frames per one million frames. The Error Insert icon shows only status.
 - **ES:** Inserts one or more errors in one second (Errored Second). Insert icon shows only status.
 - **SES:** Inserts 30% or less errors in one second (Severely Errored Second). The Error Insert icon shows only status.
2. Select the **Error destination**.
3. Touch the **Error burst length** field to set the errors insertion counts.

5.3.4.2 PDH frequency

PDH frequency is available when without SDH layer or SONET layer. Touch the field to set **Frequency Offset**. If setting a positive value, the frequency will shift higher side.

Example:

If setting 20 ppm to the frequency offset for E1 output signal, the bit rate of output signal will be

$$2\,048 * (1 + 20 * 10^{-6}) = 2\,048.041 \text{ (kbit/s)}$$

5.4 DS1/J1 Setup and Status

DS1/J1 represents the 1.544 Mbit/s PDH layer. The [Ports Setup](#) screen gives you access to the PDH layer setup for the transmitter and/or receiver of the currently selected port.

DS1/J1 allows transmission of data streams that are nominally running at the same rate, however allowing for some variation in the speed around a nominal rate (+/-125 ppm variation around 1.544 Mbit/s).

The DS1/J1 frame has one frame-bit and 24 channels during 125 μ s. A channel contains eight bits, so one DS1/J1 frame has 193 bits. The bits of channel 0 is used for multi frame.

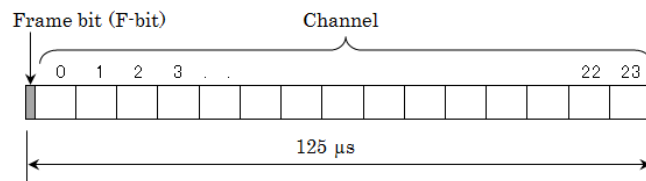

DS1/J1 Frame structure



The DS1/J1 interface uses the electrical Bantam connectors.



MU100010A Connector Panel

5.4.1 Transmitter Setup

5.4.1.1 Physical Setup

When the transmitter is set up with only a DS1/J1 interface, touching the Tx button in the navigation area will launch the following screen.

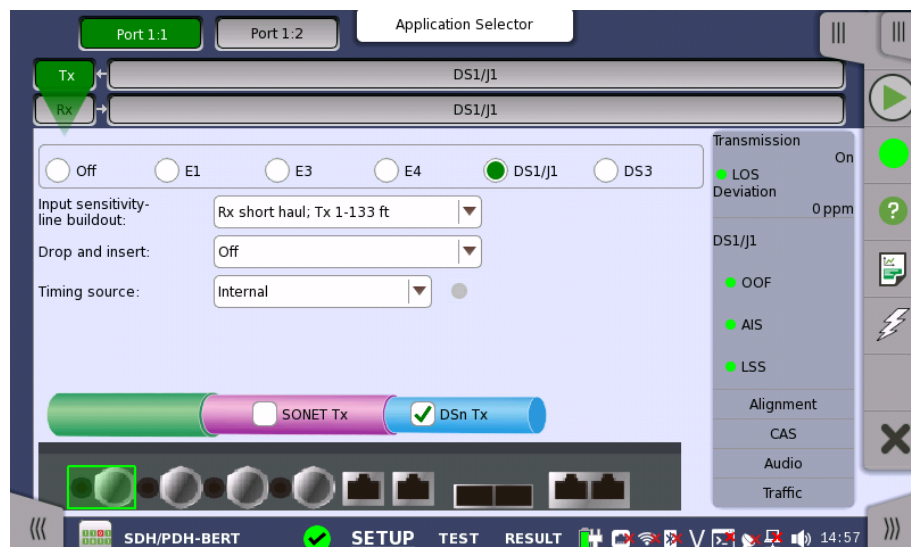

For the switching method between PDH Tx and DSn Tx, refer to [Physical Setup](#) in "E1 Setup and Status". Touching **Off** radio button disables the transmitter.

This screen allows you to make the physical setup of the PDH transmitter in DS1/J1 mode. It can also be used to inspect the current status of the selected port.

The configuration options available in the setup area of the screen are described below. The status information is described in a separate section.

The output signal goes to the corresponding Bantam connector.

Input sensitivity - line buildout

Select the line build-out. The available values are:

- Rx short haul; Tx 1-133 ft
- Rx short haul; Tx 133-266 ft
- Rx short haul; Tx 266-399 ft
- Rx short haul; Tx 399-533 ft
- Rx short haul; Tx 533-655 ft
- Rx gain mode (Monitor)
- Rx long haul; Tx 0 db
- Rx long haul; Tx -7.5 db
- Rx long haul; Tx -15 db
- Rx long haul; Tx -22.5 db

Drop and insert

Select the source for the transmitter.

On: transmits the received data which the data generated in the Network Master has added.

Off: transmits the data generated in the Network Master.

Timing source

Select the clock source.

Internal: Internal clock of the module

External: The clock provided from the Ext Clock connector

Received: The clock generated from the received signal

When **External** or **Received** is set, the right hand lamp indicates whether clock is detected or not.

5.4.1.2 DS1/J1 Signal Setup

Touching the navigation area button which represents the transmitter's DS1/J1 layer will display the screen.

Follows

To make the Port 2 transmitter follow the Port 1 transmitter (i.e. copy its settings) when using Port 1 and Port 2, touch the drop-down menu in the navigation area and select the **Tx1**. The Port 2 settings continue to follow the Port 1 transmitter change. The default setting is **None**. Note that the Port 1 transmitter cannot follow the Port 2 transmitter.

Frame tab page

The **Frame** tab page contains the following parameters:

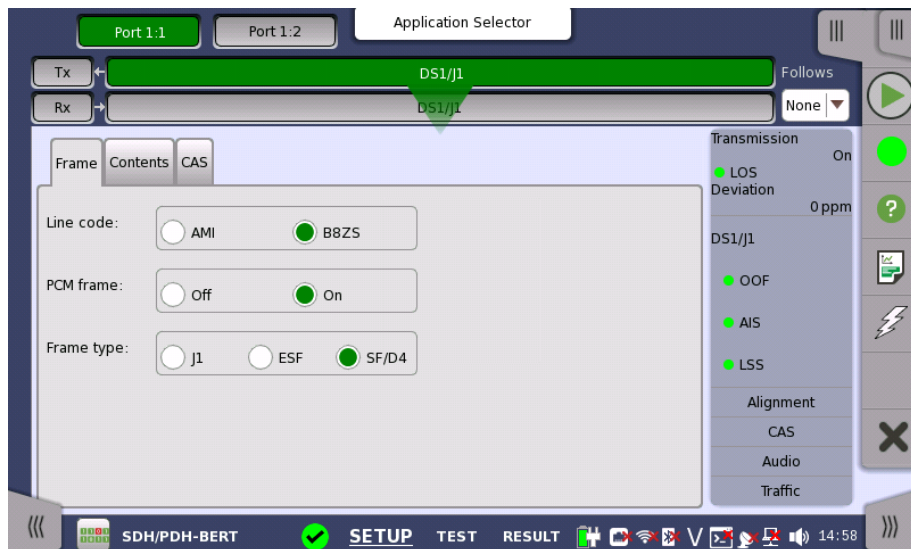

Line code

Use the **Line code** radio buttons to select transmission line code.

- **AMI**: Alternate Mark Inversion
- **B8ZS**: Bipolar Eight Zero Substitution

PCM frame

Use the **PCM frame** radio buttons to enable (**On**) or disable (**Off**) insertion of PCM frame in the transmitted signal.



When PCM frame is set to Off, many of the following transmitter parameters are insignificant.

Frame type

Use the **Frame type** radio buttons to select the relevant frame type: **J1**, **ESF** or **SF/D4**.

Content tab page

The **Content** tab page contains the following parameters:

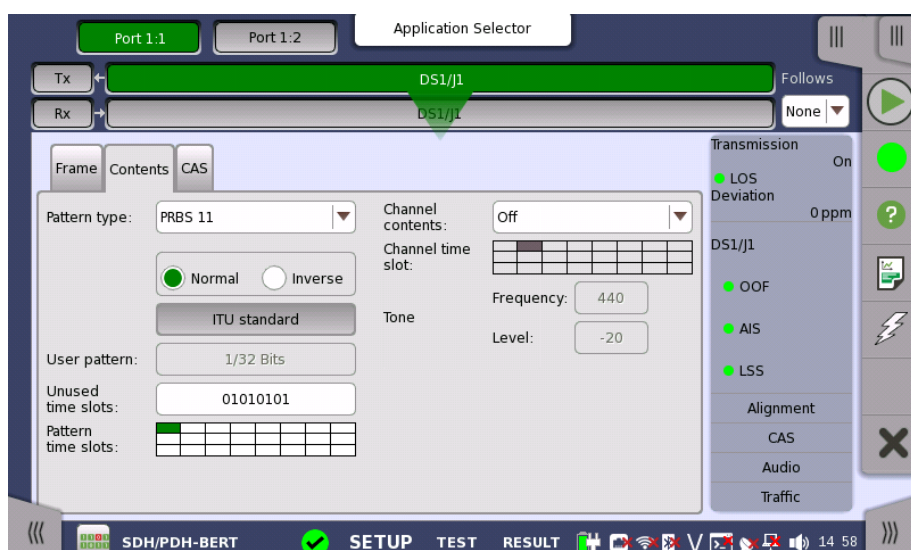

Pattern type

Select the pattern to be inserted in the transmitted signal. Refer to [Pattern type](#) in "E1 Setup and Status". Available patterns are:

- Off
- User [32] bit, User [2048] bit
- PRBS 9 to PRBS 31
- QRSS 20
- Fox Pattern, Fox (CMA3000)
- All 0's, All 1's
- Alternating 1:1, Alternating 1:3, Alternating 1:7, Alternating 3:24

Touch 'Normal' or 'Inverse' pattern type.

Touching the 'ITU standard' button will apply ITU-T O.150 recommended **Pattern type** for N x 64 kbps data rates (PRBS 11).

User pattern

User pattern field is enabled if Pattern type is set to **User [32] bit** or **User [2084] bit**. Touch the **User pattern** field and use the launched **Pattern Editor** dialog box to define the user pattern. Depending on the selected pattern type, different user pattern setup options will be available.

The length can be any length from 1 bit to 32 bits or from 1 bit to 2048 bits.

Unused time slots

Touch the **Unused time slots** button and use the dialog box to define the unused time slots.



In the **Unused Time Slots** dialog box, change the individual bits by touching on the relevant bit keys - this will toggle the bit key's binary value from logic 1 to 0 or vice versa. Touch **Ok** to accept the changes and close the dialog box.

Pattern time slots

Touch the **Pattern time slots** graphics and use the dialog box to select the timeslots in which the pattern will be inserted. Set and clear timeslots as relevant.

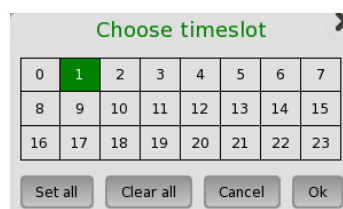
**Channel contents**

Use the top **Channel contents** drop-down menu to select where to transmit the previously defined signal in the timeslot. The signal can either be a speech sequence or a tone, as defined in the tone fields:

- **Off:** No channel content is selected.
- **Tone:** Tone with specified frequency and level.
- **Transparent:** Received content in the same channel time slot is used.
- **Speech:** Pre-programmed speech sequence. 'Drop and insert' on Tx screen will be switched to On.

Channel Time Slot

Touch the **Channel Time Slot** graphics and use the launched dialog box to select the timeslot to insert the Audio signal.



Tone

Touch the **Frequency** field and use the launched dialog box to key in the frequency, using the numeric soft keys.

Touch the **Level** field and use the launched dialog box to key in the level.

CAS tab page

The **CAS** tab page contains the following parameters:

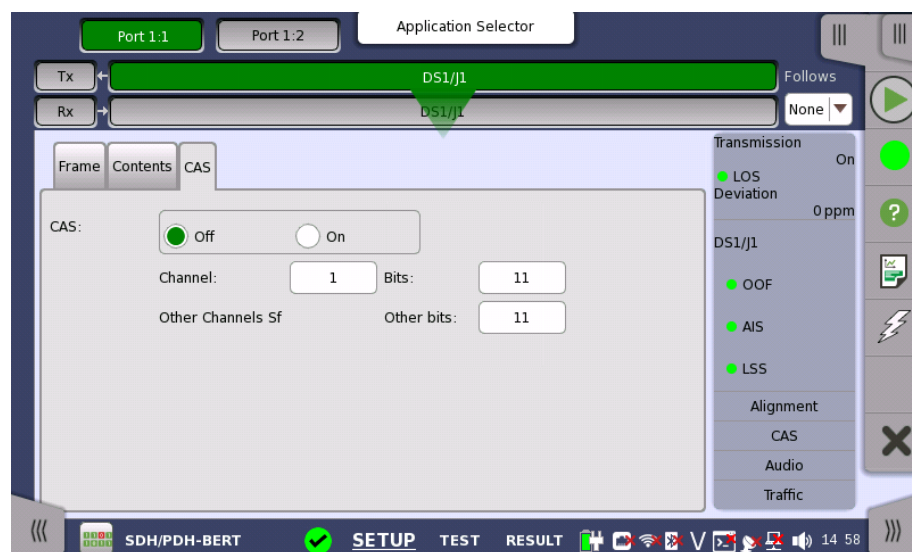

CAS

Use the **CAS** radio buttons to enable (**On**) or disable (**Off**) the insertion of a CAS (Channel Associated Signaling).

Touch the **Channel**, **Bits** and **Other bits** fields to define the contents of a selectable CAS channel as well as the remaining channels.

5.4.2 Receiver Setup

5.4.2.1 Physical Setup

When the receiver is set up with only a DS1/J1 interface, touching the **Rx** button in the navigation area will launch the following screen.

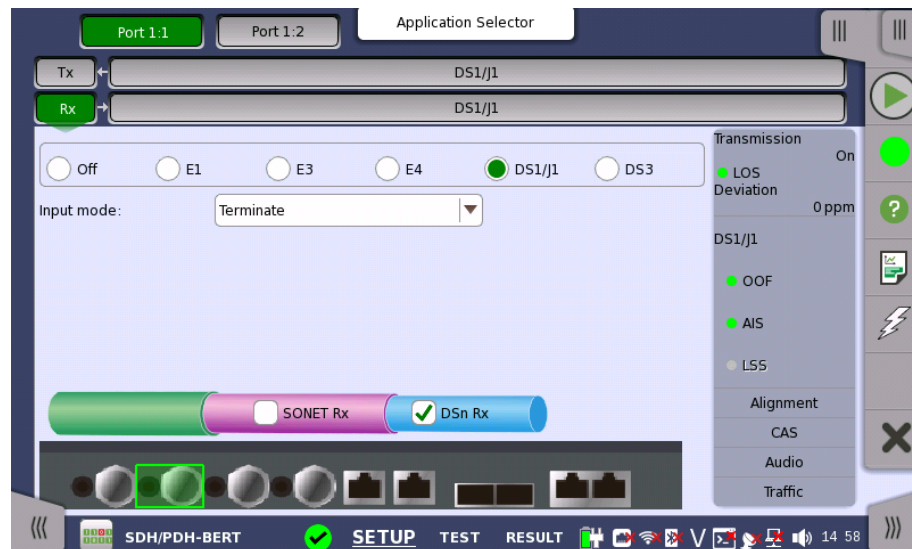

For the switching method between PDH Rx and DSn Rx, refer to [Physical Setup](#) in "E1 Setup and Status". Touch **DS1/J1** radio button. Touching **Off** radio button disables the receiver.

This screen allows you to make the physical setup of the PDH receiver in DS1/J1 mode. It can also be used to inspect the current status of the selected port.

The input signal is taken from the corresponding Bantam connector.

Input mode

Select the mode of input.

Terminate

Used when the instrument is used as a tester and the receiver is the only device connected to the line. The input impedance is nominal.

Bridged

Used when the receiver is connected directly in parallel to a line carrying live traffic. Please observe that this way of connecting may disturb the monitored line - connection through a protected monitor point, as well as using the input mode **Monitor**, is recommended instead.

Monitor

Used when connecting to protected monitoring points. The input impedance is nominal.

5.4.2.2 DS1/J1 Signal Setup

Touching the navigation area button which represents the receiver's DS1/J1 layer will display the screen.

Follows

To make the currently selected receiver follow either the transmitter or Port 1 receiver (i.e. copy its settings), touch the drop-down menu in the navigation area and select the relevant value. The receiver settings continue to follow the change of either the transmitter or Port 1 receiver. The default setting is **None**. Note that the Port 1 receiver cannot follow the Port 2 receiver.

Frame tab page

The **Frame** tab page contains the following parameters:

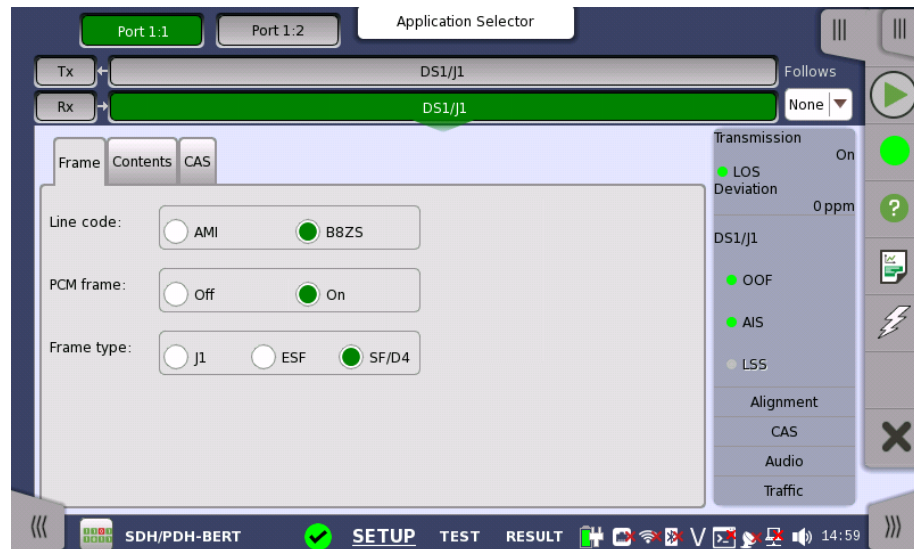
**Line code**

Use the **Line code** radio buttons to select transmission line code AMI or B8ZS.



*For normal 1.544 Mbps systems choose **B8ZS**. **AMI** is for special applications only.*

PCM frame

Use the **PCM frame** radio buttons to enable (**On**) or disable (**Off**) the status of the PCM frame.

Frame type

Select the relevant frame type: **J1**, **ESF** or **SF/D4**.

Content tab page

The **Content** tab page contains the following parameters:

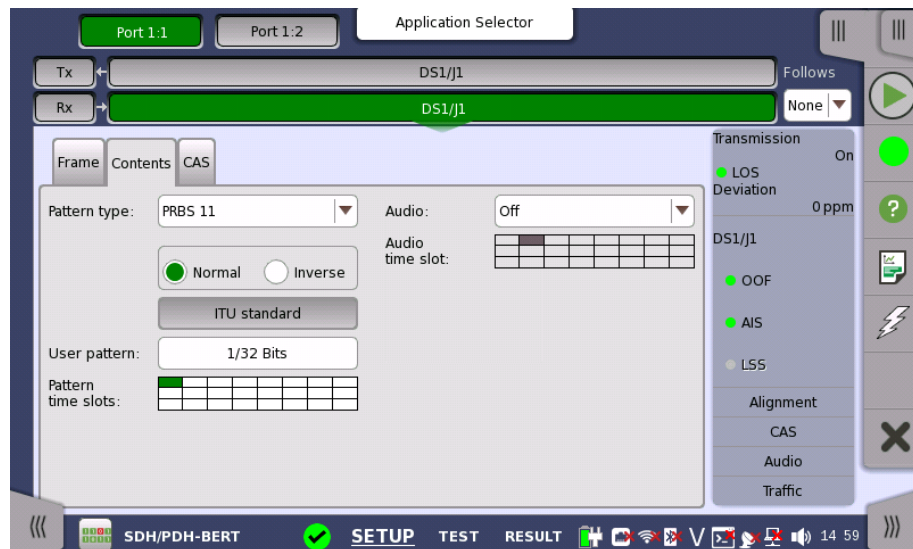

Pattern type

Select the requested pattern. Available patterns are the same as the transmitter setup. Refer to [Pattern type](#) in "E1 Setup and Status".

Touch 'Normal' or 'Inverse' pattern type.

Touching the 'ITU standard' button will apply ITU-T O.150 recommended **Pattern type** for $N \times 64$ kbps data rates (PRBS 11).

User pattern

User pattern field is enabled if Pattern type is set to **User [32] bit** or **User [2084] bit**. Touch the **User pattern** field and use the launched **Pattern Editor** dialog box to define the user pattern. Depending on the selected pattern type, different user pattern setup options will be available.

The length can be any length from 1 bit to 32 bits or from 1 bit to 2048 bits.

Pattern time slots

Touch the **Pattern time slots** graphics and use the launched dialog box to select the timeslot which will receive the Channel Content signal. Set and clear timeslots as relevant.

Audio

Use the **Audio** drop-down menu and select the features for the receiver decoding. Select On to enable the audio decoding or Off to disable.

Audio Time Slot

Touch the **Audio Time Slot** button and use the launched dialog box to select the monitored audio timeslot.

CAS tab page

The **CAS** tab page contains the following parameters:

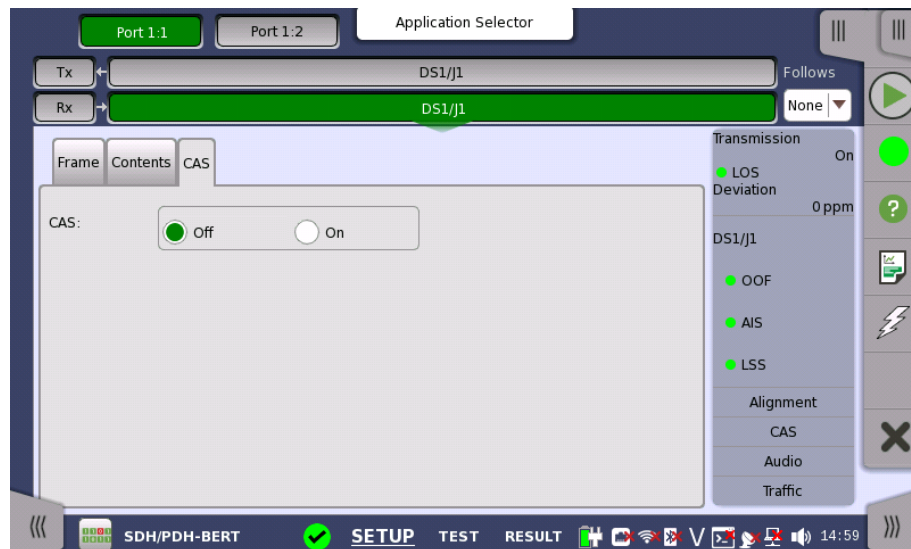

CAS

Use the **CAS** radio buttons to enable (**On**) or disable (**Off**) the reception of a CAS (Channel Associated Signaling).

5.4.3 Status Information

This section describes the status information available for the DS1/J1 layer in the status area of the **Ports Setup** screen.

5.4.3.1 Status Summary

The status summary displayed for the DS1/J1 layer consists of the following information:

Physical Status

The topmost part of the status area gives you access to information about the current physical status of the selected interface. A summary consisting of the most relevant status indicators is displayed constantly. By touching the summary, you can launch a display that contains the detailed status information.

Alarm/Error Status

The middle part of the status area gives you access to alarm and error information for the selected interface. The current status is indicated by the lamp color.

A summary consisting of the most relevant alarm/error indications is displayed constantly. By touching the summary, you can launch a display that contains all alarms/errors.

Monitor Buttons

At the bottom of the status area are below buttons that give you access to various monitor information. By touching a button, you can launch the corresponding information display.

- **Alignment**
- **CAS**
- **Audio**
- **Traffic**

5.4.3.2 Physical Details

Refer to [Physical Details](#) in "E1 Setup and Status". The nominal bit rate of DS1/J1 is 1 544 000 bps.

5.4.3.3 Alarms and Errors

Touching the middle summary box in the status area of the **Ports Setup** screen displays the status shown below.

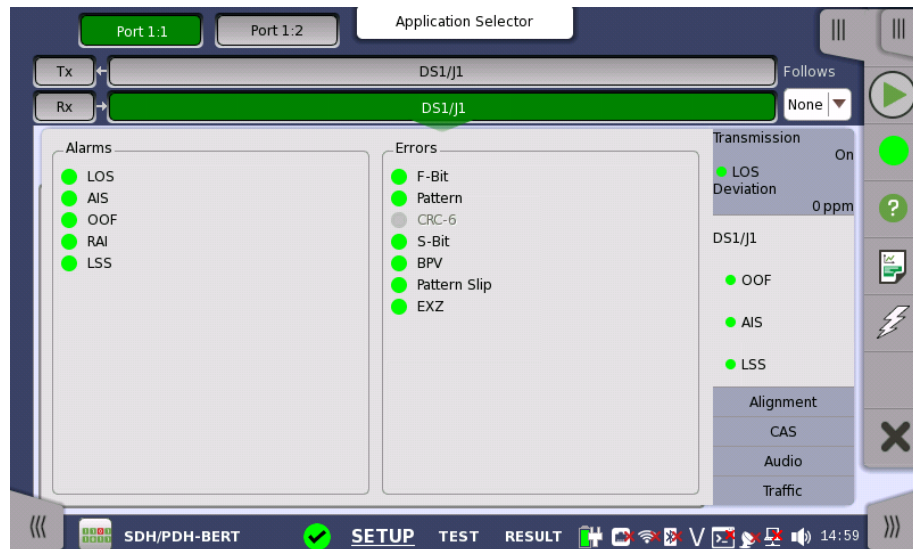

This screen contains detailed alarm and error information related to the DS1/J1 interface. Status is indicated by the use of [colored Lamp icons](#).

Alarms

- **LOS:** Loss of Signal
- **AIS:** Alarm Indication Signal
- **OOF:** Out of Frame
- **RAI:** Remote Alarm Indication
- **LSS:** Link Status Signal

Errors

- **F-Bit:** F-Bit Error
- **Pattern:** Pattern
- **CRC-6:** Cyclic Redundancy Check 6
- **S-Bit:** S-Bit Error
- **BPV:** Bipolar Violation
- **Pattern Slip:** Pattern slips
- **EXZ :** Excessive zeros

5.4.3.4 Alignment

Touching the **Alignment** button in the status area of the **Ports Setup** screen displays the status shown below.

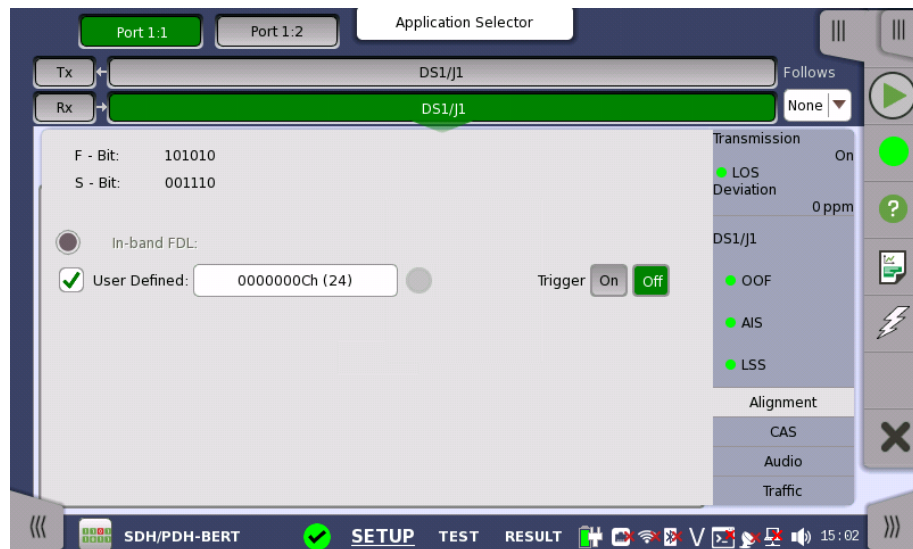

This screen provides information on the frame alignment when available.

F-Bit and M-bit are displayed when the frame type is **J1** or **ESF**.

F-Bit and S-bit are displayed when the frame type is **SF/D4**.

In-band FDL

Displays the In-band FDL (Facility Data Link) data.

Trigger

Set **On** to hold displaying FDL if In-band FDL matches. If set **Off**, the latest In-band FDL is displayed.

User Defined

Select the check box to edit the user defined inband code. Touching the field launches the pattern editor.



You can set the user defined inband code for the transmitter by the stimuli setup in Application Toolbar.

5.4.3.5 CAS

Touching the **CAS** button in the status area of the **Ports Setup** screen launches the status shown below.

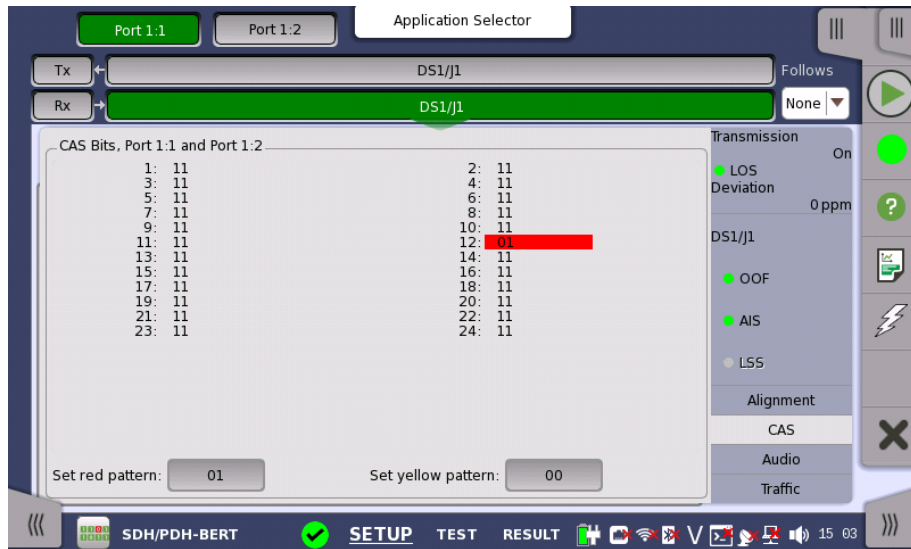

This screen gives information on the CAS (Channel Associated Signaling) signaling when available. It displays the state of the two signaling bits in both directions for all 24 channels. Activity is indicated with bold characters.

Use of colors

For easy recognition of special bit combinations, coloring is available. Use the **Set red pattern** and **Set yellow pattern** buttons to launch the respective setup dialog boxes.



The color pattern consists of four binary digits for ESF/J1 frame. For SF/D4 frame, it consists of two binary digits. The minimum acceptable value is 00 or 0000, and the maximum acceptable value is 11 or 1111. Touch the digit buttons to set the relevant value and then touch **Ok**.

To clear the whole word e.g. to make the line ready for new digit settings, touch the **Clear all** button.

5.4.3.6 Audio

Refer to [Audio](#) in "E1 Setup and Status".

5.4.3.7 Traffic

Refer to [Traffic](#) in "E1 Setup and Status". In DS1/J1 Traffic status screen, the 24 traffics are displayed.

5.4.4 Errors/Alarms Insertion

Refer to [Errors/Alarms Insertion](#) in E1 Setup and Status section.

5.5 E3 Setup and Status

E3 represents the 34.368 Mbit/s PDH layer. The [Ports Setup](#) screen gives you access to the PDH layer setup for the transmitter and/or receiver of the currently selected port.

E3 allows transmission of data streams that are nominally running at the same rate, however allowing for some variation in the speed around a nominal rate (+/-125 ppm variation around 34.368 Mbit/s).

E3 frame defined by ITU-T G.751 has 1536 bits during the period of 22.375 kHz. 12 bits are assigned to the overhead, and 4 bits parity are available as an option.

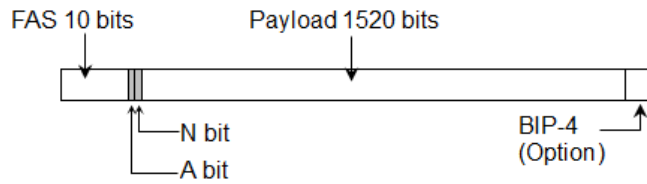

E3 Frame Structure



The E3 interface uses the electrical BNC connectors.

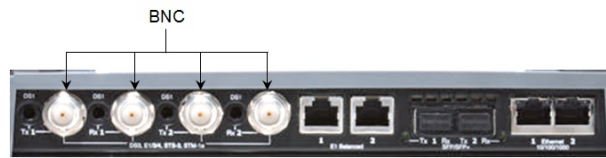

MU100010A Connector Panel

5.5.1 Transmitter Setup

5.5.1.1 Physical Setup

When the transmitter is set up with only an E3 interface, selecting the Tx button in the navigation area will launch the following screen.



For the switching method between PDH Tx and DSn Tx, refer to [Physical Setup](#) in "E1 Setup and Status". Touch **E3** radio button. Touching **Off** radio button disables the transmitter.

This screen allows you to make the physical setup of the PDH transmitter in E3 mode. It can also be used to inspect the current status of the selected port.

The configuration options available in the setup area of the screen are described below. The status information is described in a separate section.

Timing source

Select the clock source.

Internal: Internal clock of the module

External: The clock provided from the Ext Clock connector

Received: The clock generated from the received signal

When **External** or **Received** is set, the right hand lamp indicates whether clock is detected or not.

5.5.1.2 E3 Signal Setup

Touching the navigation area button which represents the transmitter's E3 layer will display the screen shown below.

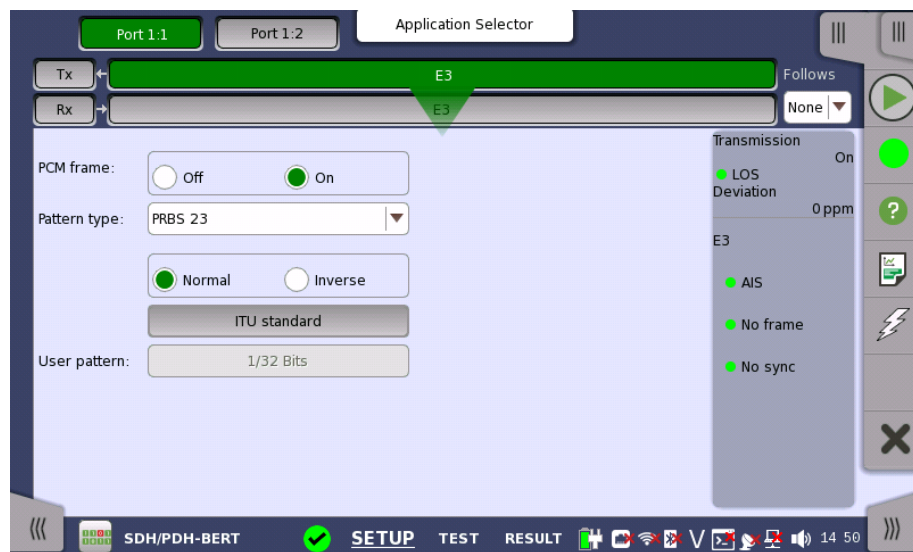

Follows

To make the Port 2 transmitter follow the Port 1 transmitter (i.e. copy its settings) when using Port 1 and Port 2, touch the drop-down menu in the navigation area and select the **Tx1**. The Port 2 settings continue to follow the Port 1 transmitter change. The default setting is **None**. Note that the Port 1 transmitter cannot follow the Port 2 transmitter.

PCM frame

Use the **PCM frame** radio buttons to enable (**On**) or disable (**Off**) insertion of PCM frame in the transmitted signal.

Pattern type

Select the pattern to be inserted in the transmitted signal. Available patterns are the same as the transmitter setup. Refer to [Pattern type](#) in "E1 Setup and Status". Available patterns are:

- Off
- User [32] bit, User [2048] bit
- PRBS 9 to PRBS 31
- Fox Pattern, Fox (CMA3000)
- All 0's, All 1's
- Alternating 1:1, Alternating 1:3, Alternating 1:7, Alternating 3:24

Touch 'Normal' or 'Inverse' pattern type.

Touching the 'ITU standard' button will apply ITU-T O.150 recommended **Pattern type** for 34 Mbit data rates (PRBS 23 Inverse).

User pattern

User pattern field is enabled if Pattern type is set to **User [32] bit** or **User [2084] bit**. Touch the **User pattern** field and use the launched **Pattern Editor** dialog box to define the user pattern. Depending on the selected pattern type, different user pattern setup options will be available.

The length can be any length from 1 bit to 32 bits or from 1 bit to 2048 bits.

5.5.2 Receiver Setup

5.5.2.1 Physical Setup

When the receiver is set up with only an E3 interface, selecting the **Rx** button in the navigation area will launch the following screen.

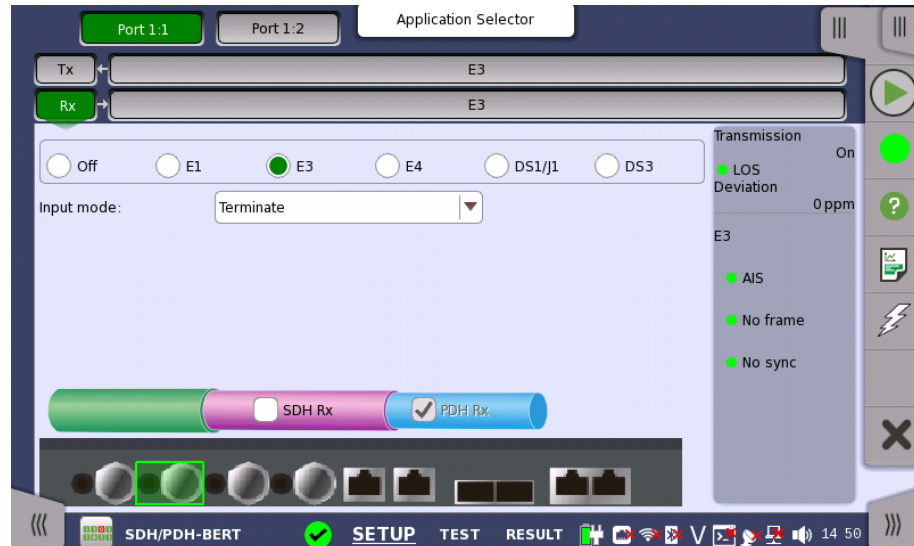

For the switching method between PDH Rx and DS_n Rx, refer to [Physical Setup](#) in "E1 Setup and Status". Touch **E3** radio button. Touching **Off** radio button disables the receiver.

This screen allows you to make the physical setup of the PDH receiver in E3 mode. It can also be used to inspect the current status of the selected port.

The configuration options available in the setup area of the screen are described below. The status information is described in a separate section.

Input mode

Select the mode of input.

Terminate

Used when the instrument is used as a tester and the receiver is the only device connected to the line. The input impedance is nominal.

Monitor

Used when connecting to protected monitoring points. The input impedance is nominal.

5.5.2.2 E3 Signal Setup

Touching the navigation area button which represents the receiver's E3 layer will display the screen shown below.

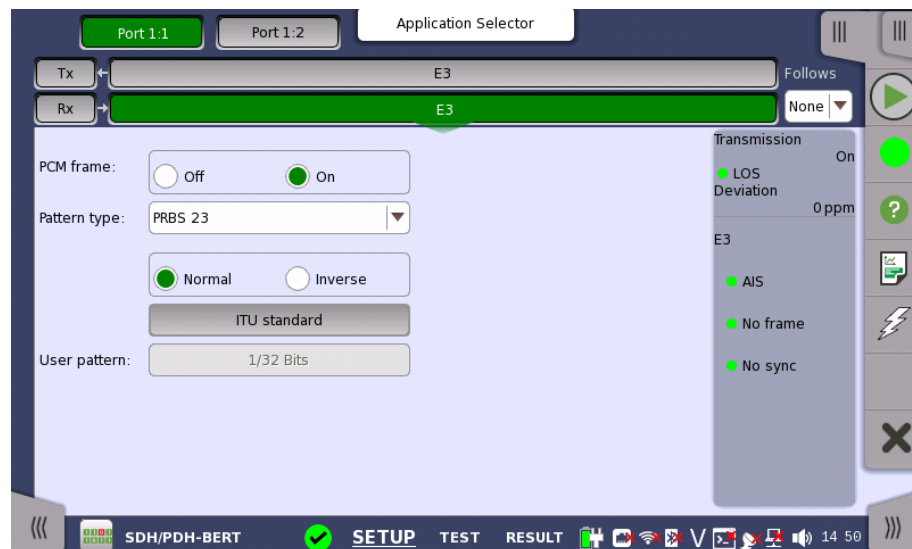
**Follows**

To make the currently selected receiver follow either the transmitter or Port 1 receiver (i.e. copy its settings), touch the drop-down menu in the navigation area and select the relevant value. The receiver settings continue to follow the change of either the transmitter or Port 1 receiver. The default setting is **None**. Note that the Port 1 receiver cannot follow the Port 2 receiver.

PCM frame

Use the **PCM frame** radio buttons to enable (**On**) or disable (**Off**) the status of the PCM frame.

Pattern type

Select the requested pattern. Available patterns are the same as the transmitter setup. Refer to [Pattern type](#) in "E1 Setup and Status".

Touch 'Normal' or 'Inverse' pattern type.

Touching the 'ITU standard' button will apply ITU-T O.150 recommended **Pattern type** for 34 Mbit data rates (PRBS 23 Inverse).

User pattern

User pattern field is enabled if Pattern type is set to **User [32] bit** or **User [2084] bit**. Touch the **User pattern** field and use the launched **Pattern Editor** dialog box to define the user pattern. Depending on the selected pattern type, different user pattern setup options will be available.

The length can be any length from 1 bit to 32 bits or from 1 bit to 2048 bits.

5.5.3 Status Information

This section describes the status information available for the E3 layer in the status area of the **Ports Setup** screen.

5.5.3.1 Status Summary

The status summary displayed for the E3 layer consists of the following information:

Physical Status

The topmost part of the status area gives you access to information about the current physical status of the selected interface. A summary consisting of the most relevant status indicators is displayed constantly. By touching the summary, you can launch a display that contains the detailed status information.

Alarm/Error Status

The middle part of the status area gives you access to alarm and error information for the selected interface. The current status is indicated by the lamp color.

A summary consisting of the most relevant alarm/error indications is displayed constantly. By touching the summary, you can launch a display that contains all alarms/errors.

5.5.3.2 Physical Details

Refer to [Physical Details](#) in "E1 Setup and Status". The nominal bit rate of E3 is 34 368 000 bps.

5.5.3.3 Alarms and Errors

Touching the middle summary box in the status area of the **Ports Setup** screen displays the status shown below.

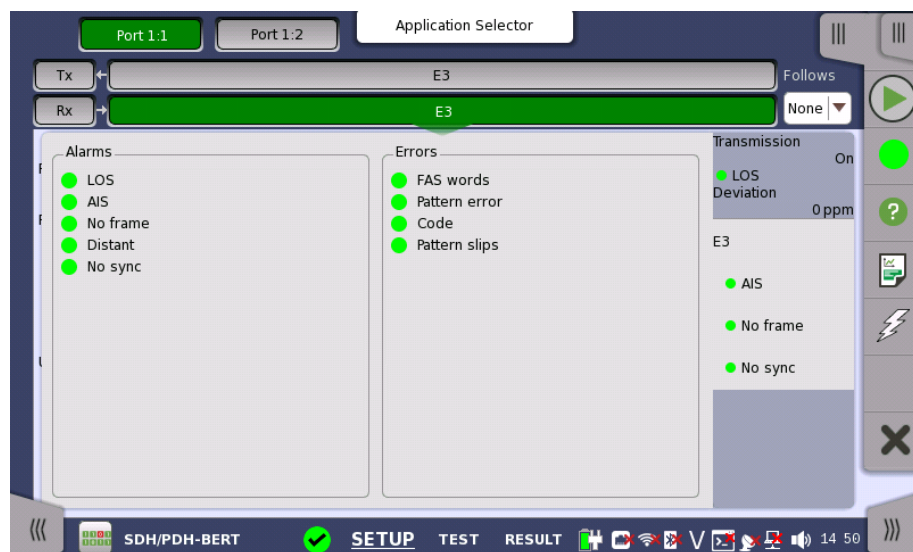

This screen contains detailed alarm and error information related to the E3 interface. Status is indicated by the use of [colored Lamp icons](#).

Alarms

- **LOS:** Loss of Signal
- **AIS:** Alarm Indication Signal
- **No frame:** No frame
- **Distant:** Distant
- **No sync:** No synchronization

Errors

- **FAS words:** Received FAS pattern does not match to "1111010000".
- **Pattern error:** Received pattern does not match to specified pattern type.
- **Code :** Code
- **Pattern slips :** Pattern slips are occurring.

5.5.4 Errors/Alarms Insertion

Refer to [Errors/Alarms Insertion](#) in E1 Setup and Status section.

5.6 DS3 Setup and Status

DS3 represents the 44.736 Mbit/s PDH layer. The [Ports Setup](#) screen gives you access to the PDH layer setup for the transmitter and/or receiver of the currently selected port.

DS3 allows transmission of data streams that are nominally running at the same rate, however allowing for some variation in the speed around a nominal rate (+/-125 ppm variation around 44.736 Mbit/s).

The DS3 frame has 56 bits of Overhead and 4704 bits of Payload, during the period of 9398.3 Hz. According to the overhead assignment, there are M13 frame and C-bit frame.

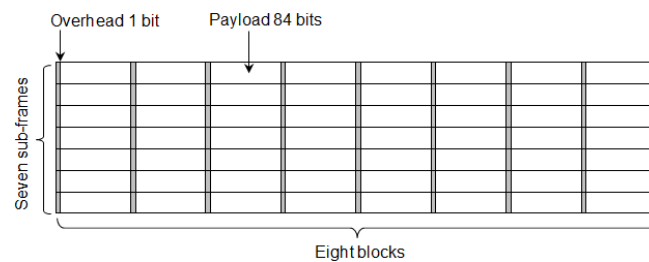

DS3 Frame structure



The DS3 interface uses the electrical BNC connectors.



MU100010A Connector Panel

5.6.1 Transmitter Setup

5.6.1.1 Physical Setup

When the transmitter is set up with only a DS3 interface, selecting the Tx button in the navigation area will launch the following screen.

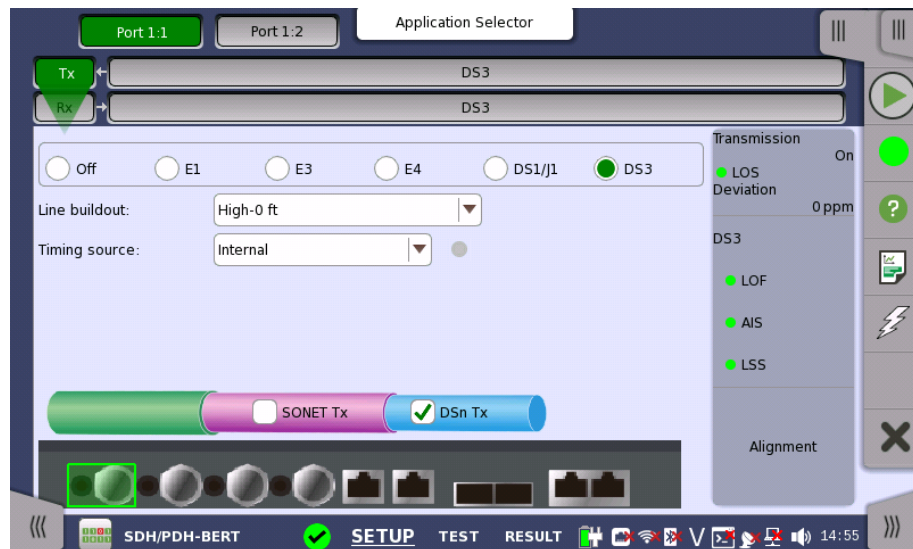

For the switching method between PDH Tx and DSn Tx, refer to [Physical Setup](#) in "E1 Setup and Status". Touch **DS3** radio button. Touching **Off** radio button disables the transmitter.

This screen allows you to make the physical setup of the PDH transmitter in DS3 mode. It can also be used to inspect the current status of the selected port.

The configuration options available in the setup area of the screen are described below. The status information is described in a separate section.

Line buildout

Select the line build-out. The available values are:

- High-0 ft
- DSX-450 ft



*To set transmission based on ITU-T G.703, select **DSX - 450 ft**.*

Timing source

Select the clock source.

Internal: Internal clock of the module

External: The clock provided from the Ext Clock connector

Received: The clock generated from the received signal

When **External** or **Received** is set, the right hand lamp indicates whether clock is detected or not.

5.6.1.2 DS3 Signal Setup

Touching the navigation area button which represents the transmitter's DS3 layer will display the screen shown below.

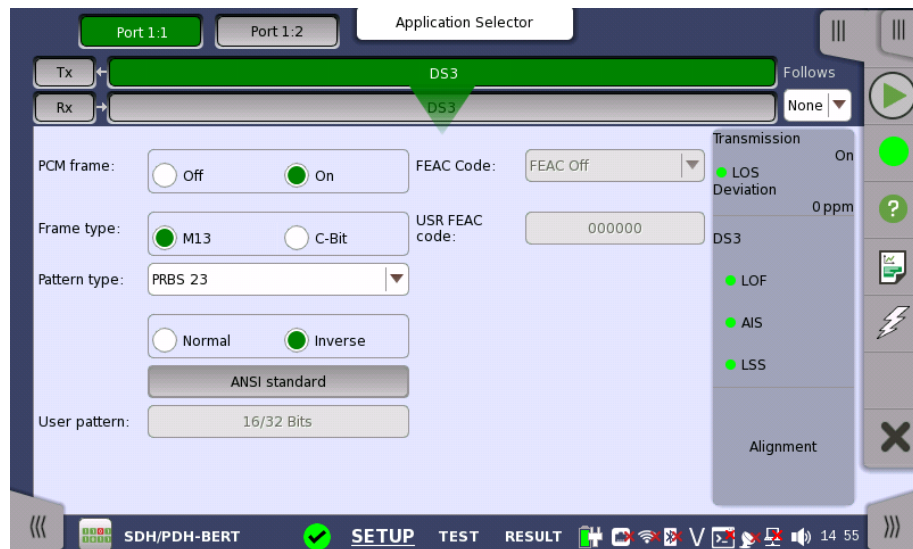

Follows

To make the Port 2 transmitter follow the Port 1 transmitter (i.e. copy its settings) when using Port 1 and Port 2, touch the drop-down menu in the navigation area and select the **Tx1**. The Port 2 settings continue to follow the Port 1 transmitter change. The default setting is **None**. Note that the Port 1 transmitter cannot follow the Port 2 transmitter.

PCM frame

Use the **PCM frame** radio buttons to enable (**On**) or disable (**Off**) insertion of PCM frame in the transmitted signal.

Frame type

Use the **Frame type** radio buttons to specify either an **M13** frame or a **C-Bit** frame.

M13 Frame Overhead

X	F1	C11	F0	C12	F0	C13	F1
X	F1	C21	F0	C22	F0	C23	F1
P	F1	C31	F0	C32	F0	C33	F1
P	F1	C41	F0	C42	F0	C43	F1
M0	F1	C51	F0	C52	F0	C53	F1
M1	F1	C61	F0	C62	F0	C63	F1
M0	F1	C71	F0	C72	F0	C73	F1

- X: Far-End Receive Failure
- P: Even-Parity
- M0: Multi-Framing Alignment 0
- M1: Multi-Framing Alignment 1
- F0,F1: Frame Alignment
- Cxx: Bit stuffing indication

C-bit Frame Overhead

X	F1	AIC	F0	NA	F0	FEAC	F1
X	F1	UDL	F0	UDL	F0	UDL	F1
P	F1	CP	F0	CP	F0	CP	F1
P	F1	FEBE	F0	FEBE	F0	FEBE	F1
M0	F1	DL	F0	DL	F0	DL	F1
M1	F1	UDL	F0	UDL	F0	UDL	F1
M0	F1	UDL	F0	UDL	F0	UDL	F1

- AIC: Application Identification
- NA: Network Application
- FEAC: Far-End Alarm and Control
- UDL: User Data Link
- CP: C-bit Parity
- FEBE: Far-End Block Error
- DL: Data Link

Pattern type

Select the pattern to be inserted in the transmitted signal. Refer to [Pattern type](#) in "E1 Setup and Status". Available patterns are:

- Off
- User [32] bit, User [2048] bit
- PRBS 9 to PRBS 31
- QRSS 20
- Fox Pattern, Fox (CMA3000)
- All 0's, All 1's
- Alternating 1:1, Alternating 1:3, Alternating 1:7, Alternating 3:24

Touch 'Normal' or 'Inverse' pattern type.

Touching the 'ANSI standard' button will apply ANSI/IEEE 1007 recommended **Pattern type** for 45 Mbit data rates (PRBS 23 Inverse).

User pattern

User pattern field is enabled if Pattern type is set to **User [32] bit** or **User [2084] bit**. Touch the **User pattern** field and use the launched **Pattern Editor** dialog box to define the user pattern. Depending on the selected pattern type, different user pattern setup options will be available.

The length can be any length from 1 bit to 32 bits or from 1 bit to 2048 bits.

FEAC Code

When 'Frame type' is set to **C-Bit**, allows you to specify the six bits of FEAC (Far-End Alarm and Control) channel code.

Option	Meaning	Cord Word
FEAC Off		-
DS3 EF	DS3 Equipment Failure Service Affecting	011001
DS3 LOF	DS3 Loss of Signal	001110
DS3 OOF	DS3 Out of Frame	000000
DS3 AIS	DS3 AIS Received	010110
DS3 Idle	DS3 Idle Signal Received	011010
DS3 EF NSA	DS3 Equipment Failure (Non-Service Affecting)	001111
DS3 CEF NSA	DS3 Common Equipment Failure (Non-Service Affecting)	011101
DS1 MLOS	Multiple DS1 LOS	010101
DS1 EF	DS1 Equipment Failure (Service Affecting)	000101
DS1 LOS	Single DS1 LOS	011110
DS1 EF NSA	DS1 Equipment Failure (Non Service Affecting)	000101
LL Active	Line Loopback Activate	000111
LL Deactive	Line Loopback De-activate	011100
User	User defined	-

USR FEAC code

When 'FEAC Code' is set to **User**, touch the **USR FEAC code** button and use the launched dialog box to define the FEAC code.

5.6.2 Receiver Setup

5.6.2.1 Physical Setup

When the receiver is set up with only a DS3 interface, selecting the **Rx** button in the navigation area will launch the following screen.

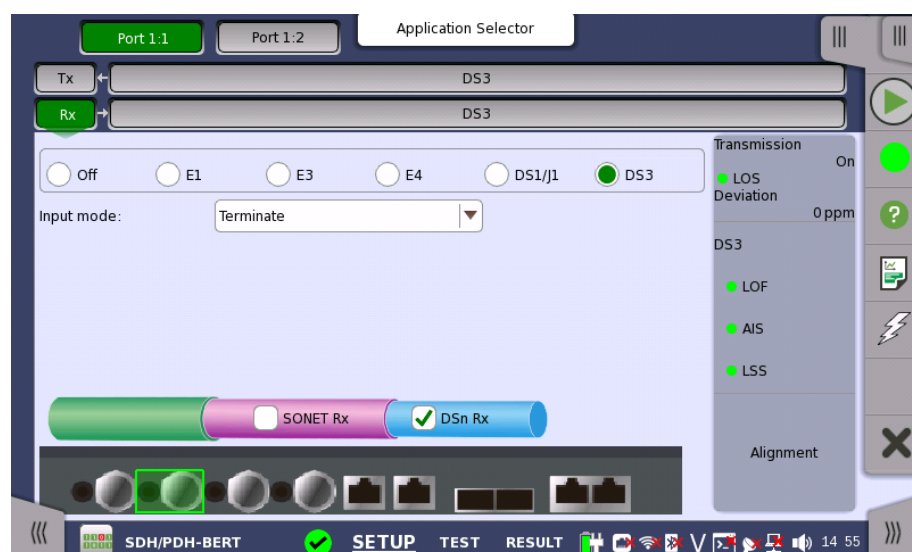

For the switching method between PDH Rx and DS_n Rx, refer to [Physical Setup](#) in "E1 Setup and Status". Touch **DS3** radio button. Touching **Off** radio button disables the receiver.

This screen allows you to make the physical setup of the PDH receiver in DS3 mode. It can also be used to inspect the current status of the selected port.

The configuration options available in the setup area of the screen are described below. The status information is described in a separate section.

Input mode

Select the mode of input.

Terminate

Used when the instrument is used as a tester and the receiver is the only device connected to the line. The input impedance is nominal.

Monitor

Used when connecting to protected monitoring points. The input impedance is nominal.

5.6.2.2 DS3 Signal Setup

Touching the navigation area button which represents the receiver's DS3 layer will display the screen shown below.

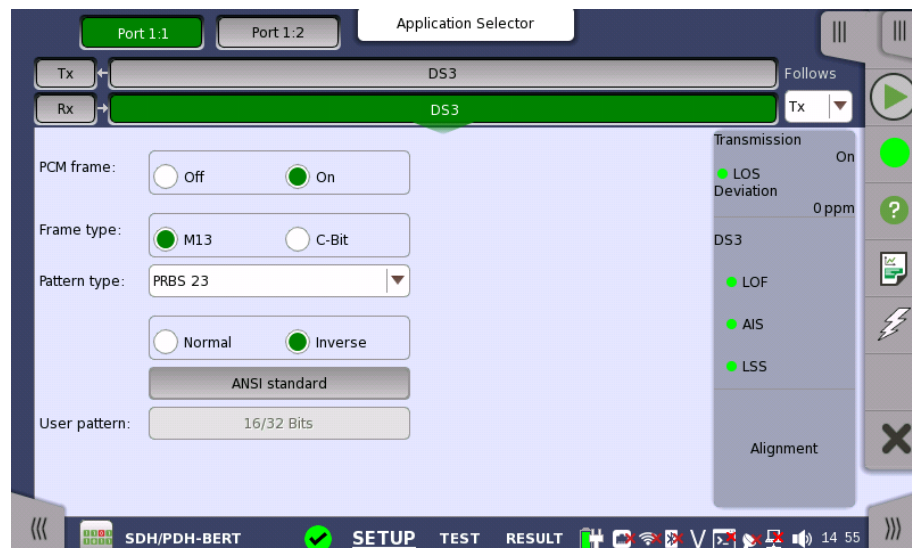

Follows

To make the currently selected receiver follow either the transmitter or Port 1 receiver (i.e. copy its settings), touch the drop-down menu in the navigation area and select the relevant value. The receiver settings continue to follow the change of either the transmitter or Port 1 receiver. The default setting is **None**. Note that the Port 1 receiver cannot follow the Port 2 receiver.

PCM frame

Use the **PCM frame** radio buttons to enable (**On**) or disable (**Off**) the status of the PCM frame.

Frame type

Use the **Frame type** radio buttons to specify either an **M13** frame or a **C-Bit** frame.

Pattern type

Select the requested pattern. Available patterns are the same as the transmitter setup. Refer to [Pattern type](#) in "E1 Setup and Status".

Touch 'Normal' or 'Inverse' pattern type.

Touching the 'ANSI standard' button will apply ANSI/IEEE 1007 recommended **Pattern type** for 45 Mbit data rates (PRBS 23 Inverse).

User pattern

User pattern field is enabled if Pattern type is set to **User [32] bit** or **User [2084] bit**. Touch the **User pattern** field and use the launched **Pattern Editor** dialog box to define the user pattern. Depending on the selected pattern type, different user pattern setup options will be available.

The length can be any length from 1 bit to 32 bits or from 1 bit to 2048 bits.

5.6.3 Status Information

This section describes the status information available for the DS3 layer in the status area of the **Ports Setup** screen.

5.6.3.1 Status Summary

The status summary displayed for the DS3 layer consists of the following information:

Physical Status

The topmost part of the status area gives you access to information about the current physical status of the selected interface. A summary consisting of the most relevant status indicators is displayed constantly. By touching the summary, you can launch a display that contains the detailed status information.

Alarm/Error Status

The middle part of the status area gives you access to alarm and error information for the selected interface. The current status is indicated by the lamp color.

A summary consisting of the most relevant alarm/error indications is displayed constantly. By touching the summary, you can launch a display that contains all alarms/errors.

Monitor Button

At the bottom of the status area are a number of buttons that give you access to various capture/monitor information. By touching a button, you can launch the corresponding information dialog.

- **Alignment**

5.6.3.2 Physical Details

Refer to [Physical Details](#) in "E1 Setup and Status". The nominal bit rate of DS3 is 44 736 000 bps.

5.6.3.3 Alarms and Errors

Touching the middle summary box in the status area of the **Ports Setup** screen allows you to launch the screen shown below.

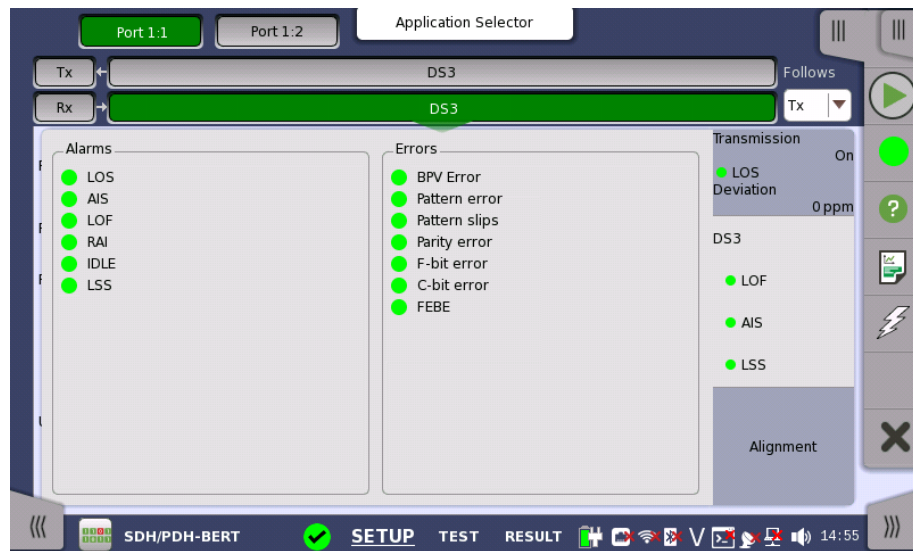

This dialog box contains detailed alarm and error information related to the DS3 interface. Status is indicated by the use of [colored Lamp icons](#).

Alarms

- **LOS:** Loss of Signal
- **AIS:** Alarm Indication Signal
- **LOF:** Loss of Frame
- **RAI:** Remote Alarm Indication
- **IDLE:** Idle Signal
- **LSS:** Link Status Signal

Errors

- **BPV Error:** Bipolar Violation error
- **Pattern error:** Pattern error
- **Pattern slips:** Pattern slips
- **Parity error:** Parity error
- **F-bit error:** F-bit error
- **C-bit error:** C-bit error
- **FEBE:** Far End Block Error

5.6.3.4 Alignment

Touching the **Alignment** button in the status area of the **Ports Setup** screen displays the status shown below.

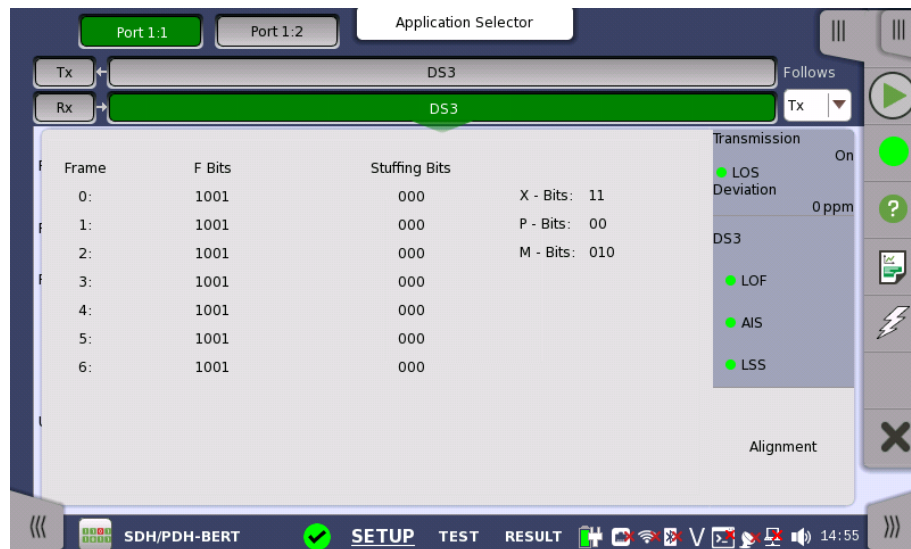

Alignment status when the frame type is M13

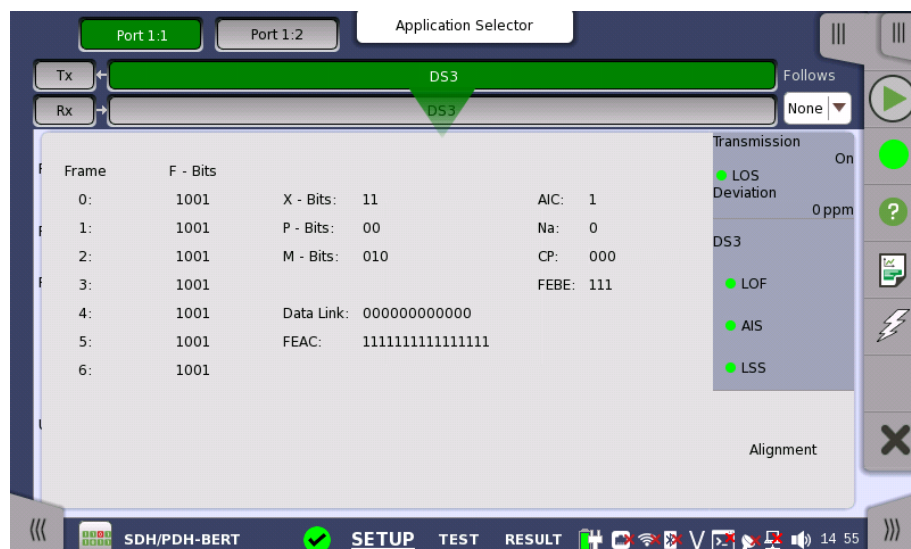

Alignment status when the frame type is C-bit

This screen provides information on the frame alignment when available. The frame alignment information includes the below bits contained in seven subframes.

- F-Bits: Framing bits
 - Stuffing Bits: Bit stuffing control bits
 - X-Bits: Message bits
 - P-Bits: Parity bits
 - M-Bits: Multiframing bits
 - AIC: Application Identification Channel
 - Na: Reserved Network Application bit
 - CP: C-bit Parity
 - FEBC: Far-End Block Error
 - Data Link: Data links for application
 - FEAC: Far-End Alarm and Control Channel
- The x of "0xxxxxx01111111" indicates [Code Word](#).

Refer to [M13 Frame Overhead](#) and [C-bit Frame Overhead](#).

5.6.4 Errors/Alarms Insertion

Refer to [Errors/Alarms Insertion](#) in E1 Setup and Status section.

5.7 E4 Setup and Status

E4 represents the 139.264 Mbit/s PDH layer. The [Ports Setup](#) screen gives you access to the PDH layer setup for the transmitter and/or receiver of the currently selected port.

E4 allows transmission of data streams that are nominally running at the same rate, however allowing for some variation in the speed around a nominal rate (+/-125 ppm variation around 139.264 Mbit/s).

E4 frame has 2988 bits consisted 6 sets of 488 bits. FAS (Frame Alignment Signal) bits are located at top of E4 frame.

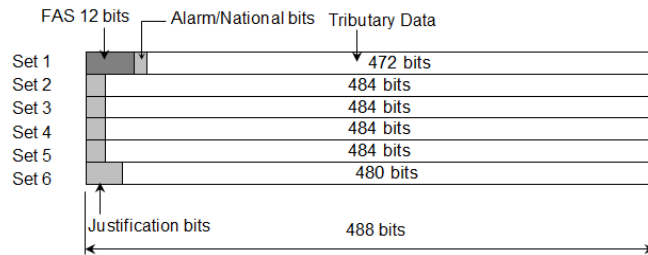

E4 Frame Structure



The E4 interface uses the electrical BNC connectors.

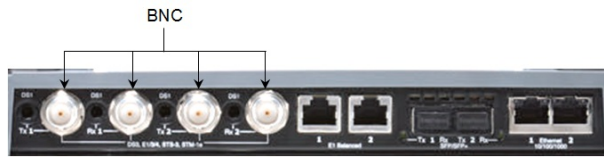

MU100010A Connector Panel

5.7.1 Transmitter Setup

5.7.1.1 Physical Setup

When the transmitter is set up with only an E4 interface, selecting the Tx button in the navigation area will launch the following screen.

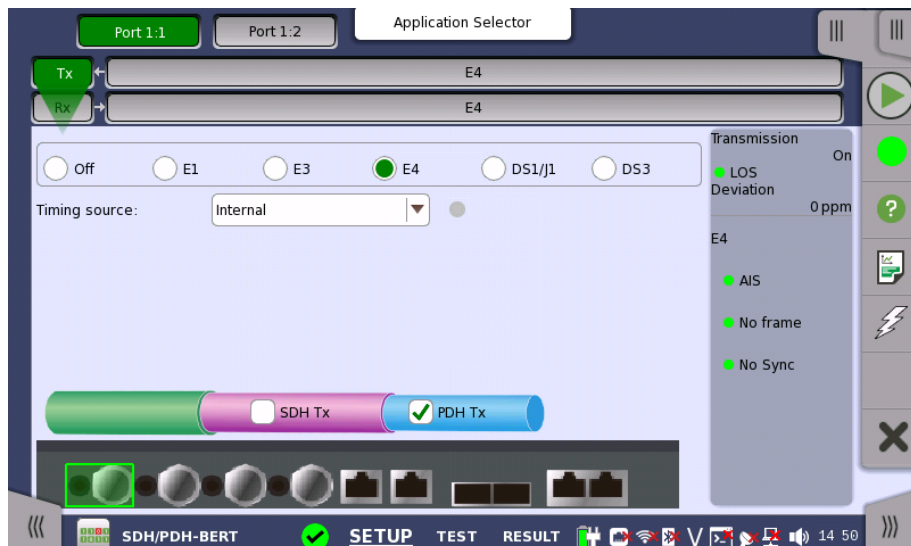

For the switching method between PDH Tx and DSn Tx, refer to [Physical Setup](#) in "E1 Setup and Status". Touch **E4** radio button. Touching **Off** radio button disables the transmitter.

This screen allows you to make the physical setup of the PDH transmitter in E4 mode. It can also be used to inspect the current status of the selected port.

The configuration options available in the setup area of the screen are described below. The status information is described in a separate section.

Timing source

Select the clock source.

Internal: Internal clock of the module

External: The clock provided from the Ext Clock connector

Received: The clock generated from the received signal

When **External** or **Received** is set, the right hand lamp indicates whether clock is detected or not.

5.7.1.2 E4 Signal Setup

Touching the navigation area button which represents the transmitter's E4 layer will display the same screen as [E3 Signal Setup](#).

Follows

To make the Port 2 transmitter follow the Port 1 transmitter (i.e. copy its settings) when using Port 1 and Port 2, touch the drop-down menu in the navigation area and select the **Tx1**. The Port 2 settings continue to follow the Port 1 transmitter change. The default setting is **None**. Note that the Port 1 transmitter cannot follow the Port 2 transmitter.

PCM frame

Use the **PCM frame** radio buttons to enable (**On**) or disable (**Off**) insertion of PCM frame in the transmitted signal.

Pattern type

Select the pattern to be inserted in the transmitted signal. Refer to [Pattern type](#) in "E1 Setup and Status". Available patterns are:

- Off
- User [32] bit, User [2048] bit
- PRBS 9 to PRBS 31
- QRSS 20
- All 0's, All 1's
- Alternating 1:1, Alternating 1:3, Alternating 1:7, Alternating 3:24

Touch 'Normal' or 'Inverse' pattern type.

Touching the 'ITU standard' button will apply ITU-T O.150 recommended **Pattern type** for 140 Mbit data rates (PRBS 23 Inverse).

User pattern

User pattern field is enabled if Pattern type is set to **User [32] bit** or **User [2048] bit**. Touch the **User pattern** field and use the launched **Pattern Editor** dialog box to define the user pattern. Depending on the selected pattern type, different user pattern setup options will be available.

The length can be any length from 1 bit to 32 bits or from 1 bit to 2048 bits.

5.7.2 Receiver Setup

5.7.2.1 Physical Setup

When the receiver is set up with only an E4 interface, selecting the **Rx** button in the navigation area will launch the following screen.

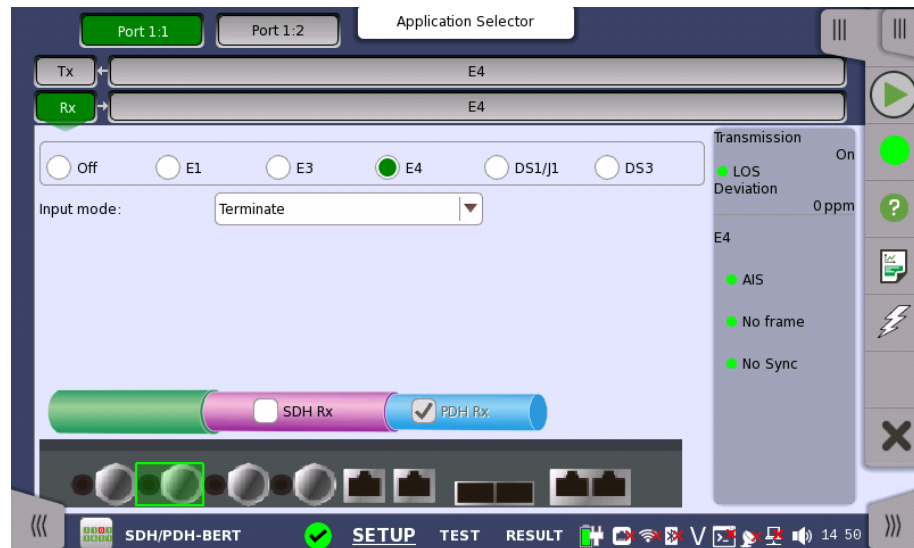

For the switching method between PDH Rx and DS_n Rx, refer to [Physical Setup](#) in "E1 Setup and Status". Touch **E4** radio button. Touching **Off** radio button disables the receiver.

This screen allows you to make the physical setup of the PDH receiver in E4 mode. It can also be used to inspect the current status of the selected port.

The configuration options available in the setup area of the screen are described below. The status information is described in a separate section.

Input mode

Select the mode of input.

Terminate

Used when the instrument is used as a tester and the receiver is the only device connected to the line. The input impedance is nominal.

Monitor

Used when connecting to protected monitoring points. The input impedance is nominal.

5.7.2.2 E4 Signal Setup

Touching the navigation area button which represents the receiver's E4 layer will display the same screen as [E3 Signal Setup](#).

Follows

To make the currently selected receiver follow either the transmitter or Port 1 receiver (i.e. copy its settings), touch the drop-down menu in the navigation area and select the relevant value. The receiver settings continue to follow the change of either the transmitter or Port 1 receiver. The default setting is **None**. Note that the Port 1 receiver cannot follow the Port 2 receiver.

PCM frame

Use the **PCM frame** radio buttons to enable (**On**) or disable (**Off**) the status of the PCM frame.

Pattern type

Select the pattern to be inserted in the transmitted signal. Available patterns are the same as the transmitter setup. Refer to [Pattern type](#) in "E1 Setup and Status".

Touch 'Normal' or 'Inverse' pattern type.

Touching the 'ITU standard' button will apply ITU-T O.150 recommended **Pattern type** for 140 Mbit data rates (PRBS 23 Inverse).

User pattern

User pattern field is enabled if Pattern type is set to **User [32] bit** or **User [2084] bit**. Touch the **User pattern** field and use the launched **Pattern Editor** dialog box to define the user pattern. Depending on the selected pattern type, different user pattern setup options will be available.

The length can be any length from 1 bit to 32 bits or from 1 bit to 2048 bits.

5.7.3 Status Information

This section describes the status information available for the E4 layer in the status area of the **Ports Setup** screen.

5.7.3.1 Status Summary

The status summary displayed for the E4 layer consists of the following information:

Physical Status

The topmost part of the status area gives you access to information about the current physical status of the selected interface. A summary consisting of the most relevant status indicators is displayed constantly. By touching the summary, you can launch a display that contains the detailed status information.

Alarm/Error Status

The middle part of the status area gives you access to alarm and error information for the selected interface. The current status is indicated by the lamp color.

A summary consisting of the most relevant alarm/error indications is displayed constantly. By touching the summary, you can launch a display that contains all alarms/errors.

5.7.3.2 Physical Details

Refer to [Physical Details](#) in "E1 Setup and Status". The nominal bit rate of E4 is 139 264 000 bps.

5.7.3.3 Alarms and Errors

Touching the middle summary box in the status area of the **Ports Setup** screen displays the status shown below.

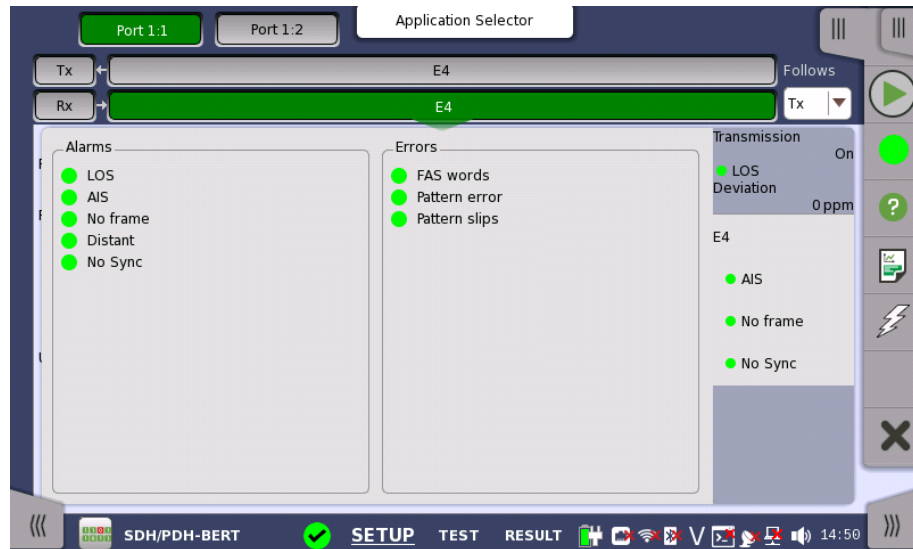

This screen contains detailed alarm and error information related to the E4 interface. Status is indicated by the use of [colored Lamp icons](#).

Alarms

- **LOS**: Loss of Signal
- **AIS**: Alarm Indication Signal
- **No frame**: No frame
- **Distant**: Distant
- **No Sync**: No synchronization

Errors

- **FAS words**: Frame Alignment Signal words
- **Pattern error**: Pattern error
- **Pattern slips**: Pattern slips

5.7.4 Errors/Alarms Insertion

Refer to [Errors/Alarms Insertion](#) in E1 Setup and Status section.

5.8 APS



The Automatic Protection Switching (APS) test described in this section is applicable for SDH/SONET/PDH/DSn interfaces.

For APS test of OTN interface, refer to [APS](#) in "OTN Application".

On SDH/SONET

K1,K2 protocol decoding is performed, as well as measurement of average and maximum duration of a specified reference event (alarm/error).

On PDH/DSn

The average and maximum duration of a specified reference event is measured, as is the number of events that have occurred.

5.8.1 Ports Setup and Status

The first step in running an application is to set up the port interfaces. This is done on the **Ports Setup** screen, which also provides port status information.

The setup options and status information related to each interface type are described in separate sections:

- [SDH Setup and Status](#)
- [SONET Setup and Status](#)
- [E1 Setup and Status](#)
- [DS1/J1 Setup and Status](#)
- [E3 Setup and Status](#)
- [DS3 Setup and Status](#)
- [E4 Setup and Status](#)
- [OTN Setup and Status](#)

Please refer to the sections relevant for your current port setup requirements.

5.8.2 Test Setup

5.8.2.1 Threshold

Touching the **Threshold** button in the navigation area displays the following screen.

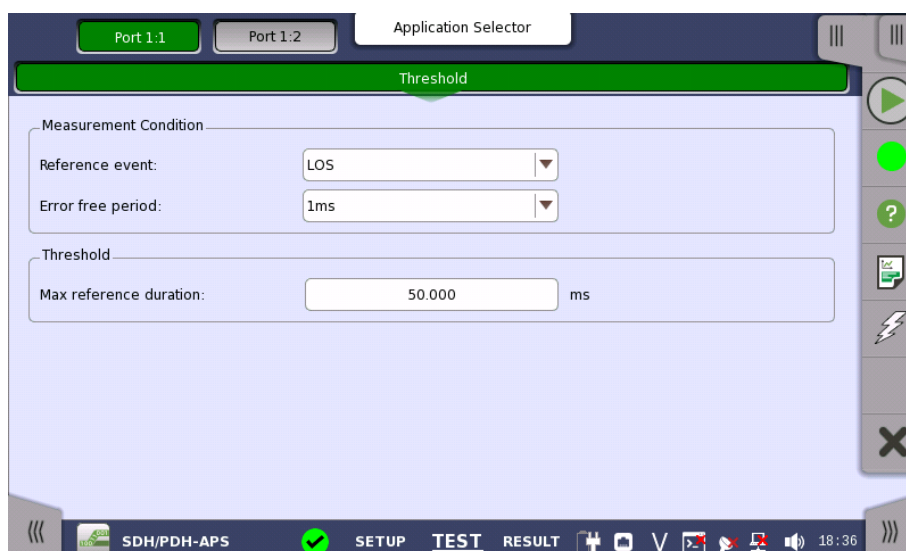

This screen contains the parameters for setting up the threshold values for alarms/errors and Pass/Fail status.

Measurement Condition

Reference event

Use the drop-down menu(s) to select the relevant event (**Any errors**, LOS, LOF, OOF etc.).

If selecting **Any errors**, all alarms and errors displayed on the list are treated as the trigger.



LOS does not appear when using the electrical interface (STM-1e or STS-3). For the PDH interfaces the lists of relevant events are different.

*The errors which can be set as Reference event do not contain all items listed in **Alarms** and **Errors** on Application Toolbar. For example, LSS and TC-REI are not handled as a trigger even if **Any errors** is selected in case of SDH.*

Error free period

Appears when SDH or SONET layer is present.

If a reference event is not generated within the time of this cycle, end the switching time measurement.

Threshold

Max reference duration

Allows you to specify the maximum duration of the selected reference event(s). Valid values are from **0.000 ms** to **10000.000 ms** for SDH/SONET and **0.000 ms** to **4000.000 ms** for PDH.



The setup of the protection and the requests used in an 'APS' test on SDH or SONET layer is done on the Test Results > Detailed screen.

5.8.3 Test Results

5.8.3.1 Summary

Touching the **Summary** button in the navigation area will display the screen shown below.

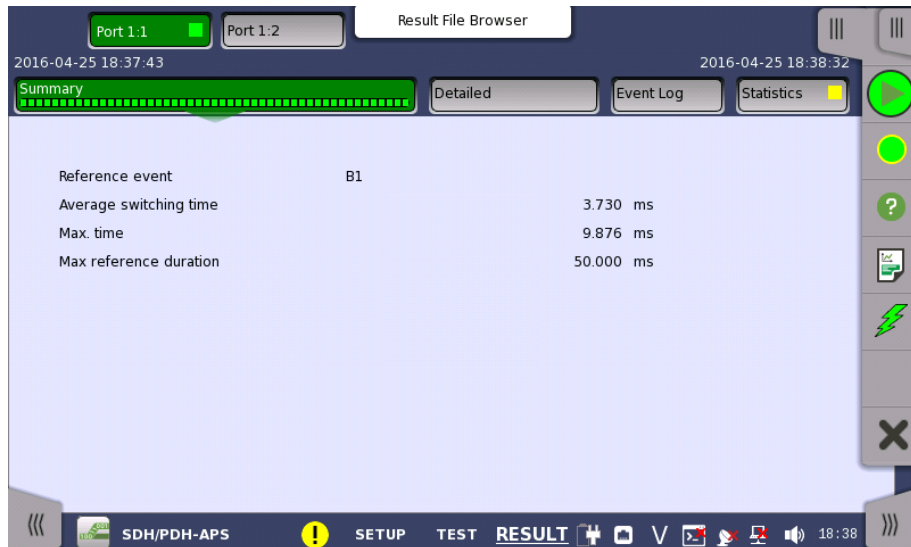

This screen presents a summary of the results of the APS test.

For each port the following information is displayed:

- Reference event
- Average switching time
- Max. time
- Max reference duration

5.8.3.2 Details for APS

Touching the **Detailed** button will display the screen shown below.

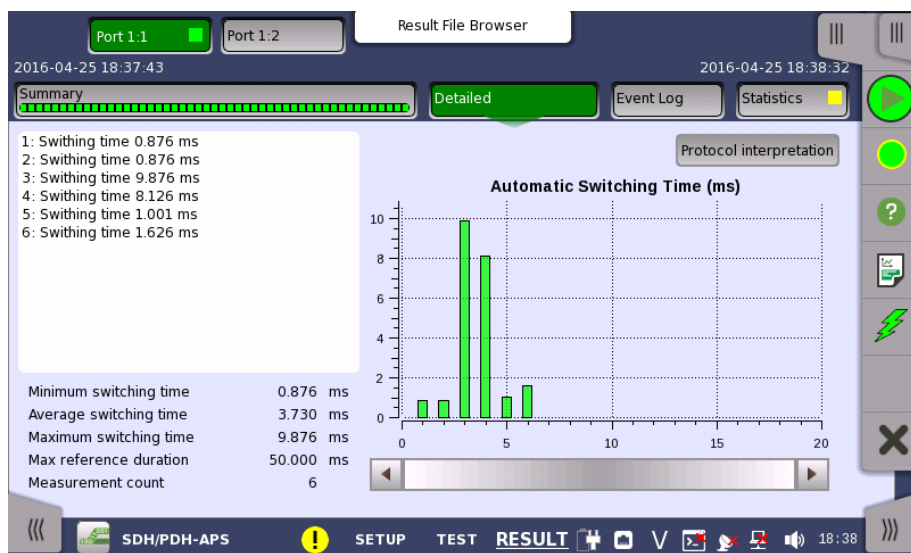

This screen shows the duration of all reference events, both in a list and in a graphic representation. This screen contains the summary field displayed below the list.

Summary field

Consists of the minimum, maximum, and average automatic switching times in milliseconds, the specified Max. reference duration value, the number of measurements.

List-form information

Presents the automatic switching times in list-form.

Graphical presentation The graphical presentation consists of a bar diagram of the automatic switching times. Results may be affected by unexpected alarms/errors.

Protocol interpretation Shows the screen displaying the Protocol interpretation.



Protection interpolation button appears when SDH or SONET layer is present.

5.8.3.3 Protocol interpretation

Touching the **Protocol interpretation** button on the **Detailed** screen will display the following screen.

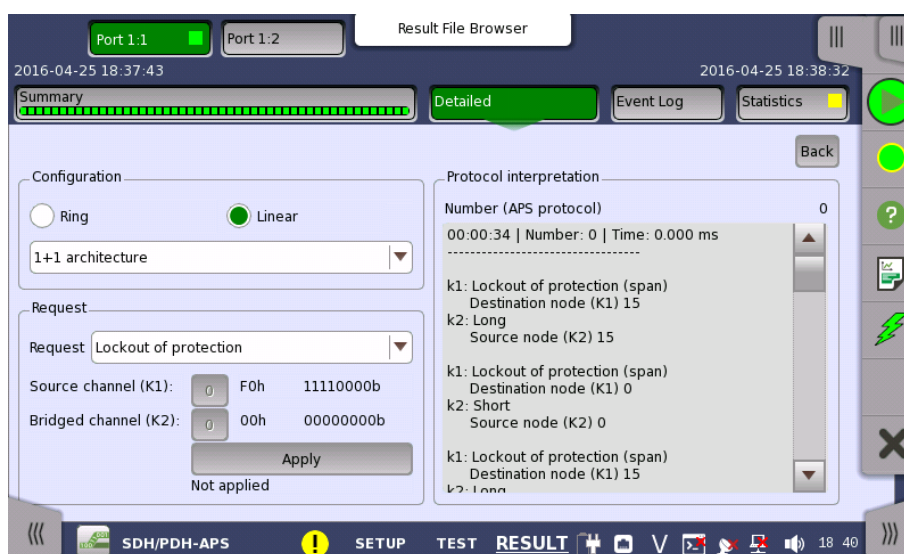

This screen shows a protocol interpretation for the selected port (i.e. detailed decoding information about K1 and K2 during the test). It also contains a set of parameters that allow you to configure the requests used in the test.

Configuration Select the configuration from below.

- **Ring:** MS shared protection ring / BLSR (Bidirectional line switched ring)
- **Linear:** Linear VC trail protection / UPSR (Unidirectional path switched ring)
- **Short path, Long path:** Type of substitute path for Ring protection.
- **1+1 architecture, 1:n architecture:** Type of the architecture for Liner protection.

Request **Request**

Use the drop-down menu to select the relevant request type (**Forced switch, Signal fail** etc.).

Destination node / Source channel (K1)

Touch the field to set the channel number of the K1 byte (bits 5-8). Possible values are **0** to **15**.

Source node / Bridged channel (K2)

Touch the field to set the channel number of the K2 byte (bits 1-4). Possible values are **0** to **15**.

Apply

Touch the **Apply** button to apply the specified APS request to the SDH/SONET transmitter.

5.8.3.4 Event Log

Touching the **Event Log** button in the navigation area displays the screen providing the event log data. Refer to [Event Log](#) of SDH/SONET/PDH/DSn BERT application.

5.8.3.5 Statistics

Touching the **Statistics** button in the navigation area displays the screen providing the statistics data. Refer to [Statistics](#) of BERT for the operation.

5.9 BERT



The Bit Error Rate Test (BERT) described in this section is applicable for SDH/SONET/PDH/DSn interfaces.

For BERT of OTN interface, refer to [BERT](#) in "OTN Application".



The interface settings on the Ports Setup screen determines whether the current application is SDH, SONET, PDH and/or DSn BERT.

5.9.1 Ports Setup and Status

The first step in running an application is to set up the port interfaces. This is done on the **Ports Setup** screen, which also provides port status information.

The setup options and status information related to each interface type are described in separate sections:

- [SDH Setup and Status](#)
- [SONET Setup and Status](#)
- [E1 Setup and Status](#)
- [DS1/J1 Setup and Status](#)
- [E3 Setup and Status](#)
- [DS3 Setup and Status](#)
- [E4 Setup and Status](#)
- [OTN Setup and Status](#)

Please refer to the sections relevant for your current port setup requirements.

5.9.2 Test Setup

5.9.2.1 Measurement Mode

Touching the **Measurement Mode** button in the navigation area displays the following screen.

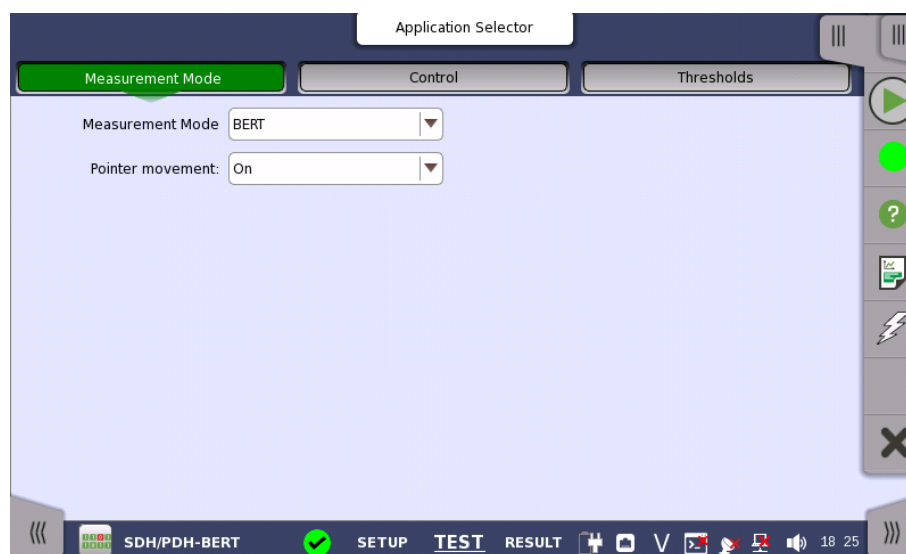

This screen allows users to switch the application.



Measurement Mode button appears in the Navigation area only when starting the BERT by Application selector.

Measurement Mode

Touch the field to select the application.

- BERT
- RTD
- APS

Pointer movement

Touch the field to select the **Pointer movement** button display in Result screen. Selecting **On** displays the **Pointer movement** button.

If selecting **Off**, **Pointer movement** button on Test screen is hidden. However, Estimate of test duration varies depending on the **Interval length** setting.

5.9.2.2 Control

Touching the **Control** button in the navigation area displays the following screen.

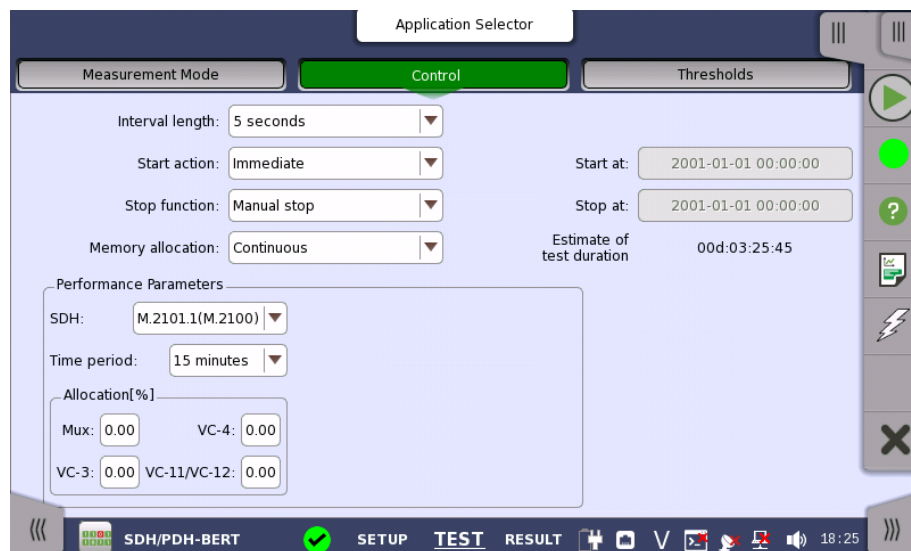

This screen contains the parameters that are generally required in a BERT test setup.

Interval length

Allows you to specify the length of the measurement intervals.

Start action

Allows you to specify when the measurement is started.

- **Immediate**: Starts the measurement when you touch the **Start** button.
- **Start at**: Starts the measurement at the time specified in the **Start at** field on the right.

Stop function

Allows you to specify when the measurement ends. Select the relevant option from the drop-down menu:

- **Manual stop:** Stops the measurement immediately when you touch the **Stop** button.
- **Stop at:** Stops the measurement at the time specified in the **Stop at** field on the right.
- **Duration:** Performs the measurement for the duration of time specified on the right.

Memory allocation

Allows you to specify how the measurement will be stored in the Network Master's memory. Select the relevant option from the drop-down menu:

- **Use all storage:** When Network Master's memory became full of measured data, the whole measurement is stopped.
- **Continuous:** When Network Master's memory became full of measured data, the oldest records in that memory will be overwritten. When the memory became full, it is recorded in [Event log](#).

The Network Master's memory size (the file size of measurement results) is 64 Mbytes per one port. The result file size is less than 64 Mbytes because it is compressed when saving to the file.

Estimate of test duration

Contains an estimation of the time (in days, hours, minutes and seconds) before the whole memory will be filled out by the test. During an ongoing measurement, the estimate will be recalculated periodically.

Performance Parameters

The titles of ITU-T Recommendation are below.

- **G.821** Error performance of an international digital connection operating at a bit rate below the primary rate and forming part of an Integrated Services Digital Network
- **G.826** End-to-end error performance parameters and objectives for international, constant bit-rate digital paths and connections
- **G.828** Error performance parameters and objectives for international, constant bit-rate synchronous digital paths
- **G.829** Error performance events for SDH multiplex and regenerator sections
- **G.8201** Error performance parameters and objectives for multi-operator international paths within the Optical Transport Network (OTN)
- **M.2100** Performance limits for bringing-into-service and maintenance of international multi-operator PDH paths and connections
- **M.2101.1** Performance limits for bringing-into-service and maintenance of international SDH paths and multiplex sections
- **M.2401** Error performance limits and procedures for bringing-into-service and maintenance of multi-operator international paths and sections within an optical transport network
- **M.2110** Bringing into service international multi-operator paths, sections and transmission systems

The performance parameters vary depending on the selected standard.

Performance Parameters

Parameter Name	PDH			SDH, SONET	OTN
	G.821	G.826	M.2100	G.826, G.828+G.829, M.2101.1	G.8201,M.2401
ES	✓	✓	✓	✓	
SES	✓	✓	✓	✓	✓
BBE		✓		✓	✓
ALS	✓	✓	✓		
UAT	✓	✓	✓		✓*
UNAV				✓	
AVT	✓	✓	✓		
EFS	✓	✓	✓		

*: "UAS" is displayed.

OTN-related

These items appear if **OTN Tx** and **OTN Rx** are selected on Setup screen.

OTN

G.8201, M.2401 (M.2110)

Time period

15 minutes, 1 hour, 2 hours, 24 hours, 7 days

Allocation

Touching the **Setup** button launches the dialog box. Refer to [Performance Parameters](#) in "OTN Application" .

SDH/SONET-related

These items appear if **SDH Tx** and **SDH Rx**, or **SONET Tx** and **SONET Rx** are selected on Setup screen.

SDH/SONET

G.826, G.828+G.829, M.2101.1(M.2100)

Time period

15 minutes, 1 hour, 2 hours, 24 hours, 7 days

Allocation [%]

Set the allocation ratio of the performance objectives defined in ITU Recommendation.

For G.826 and G.828+G.829, the PO limits used for Pass/Fail judgement are calculated by multiplying the allocation by the performance objectives of ITU Recommendation.

For M2101.1(M.2100), the PO limits are calculated by multiplying the allocation and Time period (unit in seconds) by the performance objectives of ITU Recommendation.

PDH/DSn-related

These items appear if **PDH Tx** and **PDH Rx**, or **DSn Tx** and **DSn Rx** are selected on Setup screen.

E1

G.821, G.826, M.2100, G.821 (expired)

E3

G.826, M.2100

E4

G.826, M.2100

DS1/J1

G.821, G.826, M.2100, G.821 (expired)

DS3

G.826, M.2100

Apply G.821 to the equipment designed prior to the adoption of revised ITU-T Recommendation G.826 on 14 December, 2002.

G.821(expired) is provided for backward compatibility to the previous model CMA3000. This standard is not recommended for normal use.

5.9.2.3 Thresholds

Touching the **Thresholds** button in the navigation area displays the following screen.

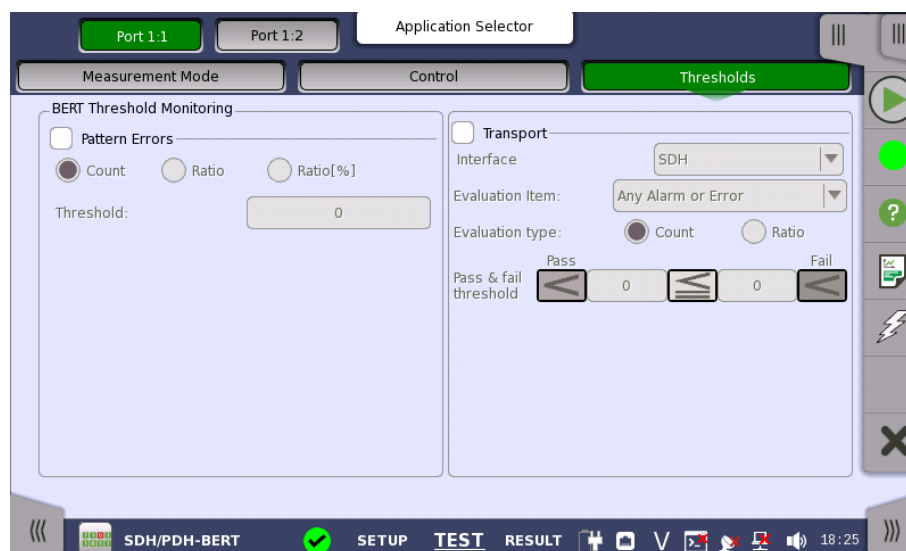

This screen contains the parameters for setting up the various threshold values (i.e. limits) for errors and Pass/Fail status that are used during the monitoring.

Pattern Errors

Allows you to enable monitoring of pattern errors (i.e. bit errors) and to set up a threshold value for the bit error ratio.

Choose whether the threshold is specified as an absolute value or a percentage, using the **Count**, **Ratio** and **Ratio [%]** radio buttons, and then specify the value in the **Threshold** field.

Transport

Select the check box to enable the transport-related parameters.

Interface

Select the item to evaluate from OTN, SDH, SONET, E4, E3, E1, DS3 or DS1/J1.

Evaluation item

Select the item to evaluate. If selecting other than **Any Alarm or Error**, another menu appears.

Evaluation type

Select the relevant type.

Pass & fail threshold

Touch the left-hand number to set the lower limit for "Warning". Touch the right-hand number to set the lower limit for "Fail". The lower limit of "Fail" must be equal to or greater than the lower limit of "Warning" (defining a "Within limits" range in between them).

5.9.3 Test Results

5.9.3.1 Summary

When you go to the test results of the SDH/SONET/PDH/DSn BERT application, the following screen is displayed.

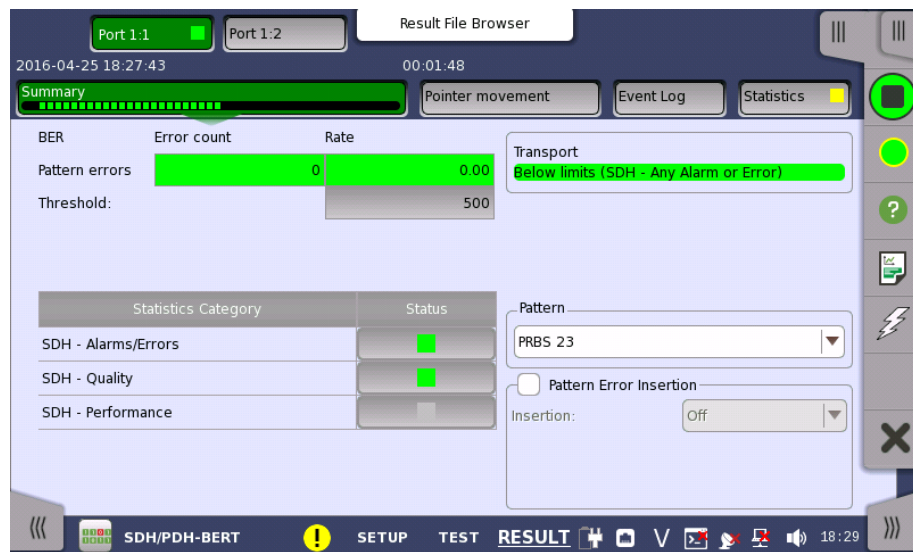

This screen contains a summary of OTN/SDH/SONET/PDH/DSn BERT results.

Statistics Category

The lamp icon in Status column shows the Pass or Fail results for each category. Touching the Status column displays the statistics results.

Transport

Displays the results of Transport test. This result appears if 'Transport' check box is selected in the Test Setup screen.

Pattern

Select the pattern.

Pattern Error Insertion

Select the check box to enable the pattern error insertion.

Insertion

Select the timing of the error insertion from the drop-down menu.

- **Off**: Stops the error insertion.
- **Manual**
- **1E-04 to 1E-10**
- **Alternate**

Burst length

If 'Insertion' is set to **Manual**, touch the button and set the burst length to insert.

Normal length

If 'Insertion' is set to **Alternate**, touch the button and set the normal length.

Error length

If 'Insertion' is set to **Alternate**, touch the button and set the error length.

5.9.3.2 Pointer Movement

Touching the **Pointer Movement** button in the navigation area displays the screen shown below.

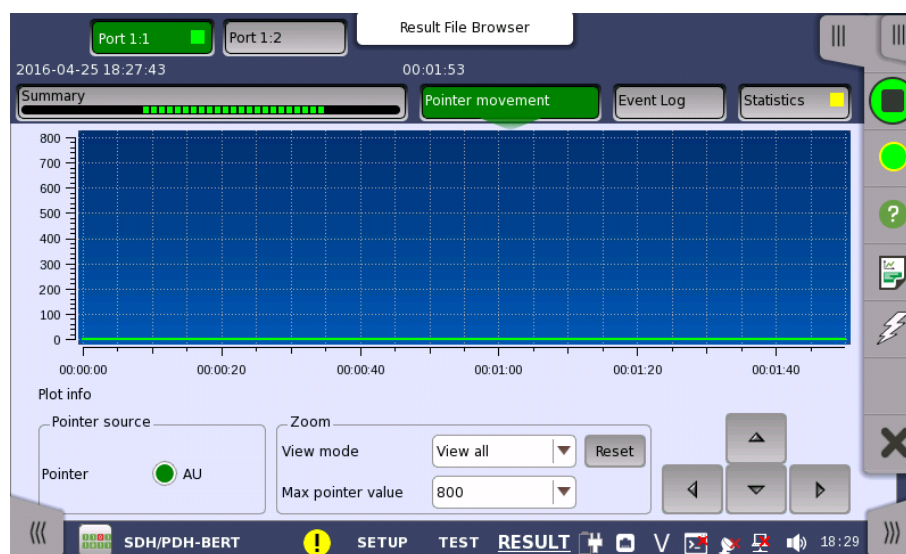

This screen presents a detailed analysis of pointer movements in the monitored signal. The results are displayed as a graph, showing the positions of a specific pointer over time.

Using the graph area itself and the controls displayed below the graph, you can specify which pointer's data is displayed as well as [zoom](#) in on specific details of the graph.



In general, you use direct touch-manipulation of the graph area to zoom in and use the controls to zoom out.

Pointer source

Pointer

Select the radio button corresponding to the pointer whose movements you want to monitor.

Zoom

To zoom in, select a zoom area directly in the graph area by drawing a rectangle with a finger or the stylus (delivered with the instrument).

When releasing the finger or stylus, the graph area zooms in to show the selected part of the graph.

To zoom out, use the view settings below the graph:

View mode

Used to set the x-scaling for the graph. The possible settings are:

- **Last 24H to Last 5m**: Shows a sliding graph area with max. width of 24 hours to 5 minutes.
- **View all**: Shows a graph area with a width as the duration of the test.
- **Custom**: This is automatically selected when the graph area is touch-manipulated.

Max pointer value

Used to set the y-scaling of the view. The maximum amplitude of the plot always originates from the zero line.

5.9.3.3 Event Log

Touching the **Event Log** button in the navigation area displays the screen shown below.

No.	Time	Port	Type	Src.	Description	Dur./Count
1	2016-04-25 18:27:43			Test	Started	
2	2016-04-25 18:28:22	1:2	●	SDH	A1A2	966
3	2016-04-25 18:28:23	1:2	●	SDH	A1A2	15.552 k
4	2016-04-25 18:28:24	1:2	●	SDH	A1A2	15.552 k
5	2016-04-25 18:28:25	1:2	●	SDH	A1A2	15.552 k
6	2016-04-25 18:28:26	1:2	●	SDH	A1A2	15.552 k
7	2016-04-25 18:28:27	1:2	●	SDH	A1A2	15.552 k
8	2016-04-25 18:28:28	1:2	●	SDH	A1A2	15.552 k
9	2016-04-25 18:28:29	1:2	●	SDH	A1A2	15.372 k

Event log display functions

The slide-out panel on the left-hand side of the screen contains the following event log functions:

- Define time format.
- Enabling event log filter.
- Event log filter configuration.
- Clear event log filter configuration.

Summary Pointer movement Event Log

Filter Clear filter Time format: Absolute

Event Number range

Only from specific source(s) From: 1

Specify To: 1

SDH Date/Time range

From: 2001-01-01 00:00:00

For an event to be displayed, it must pass the **Event** filter, the **Number range** filter and the **Date/Time range** filter if they are all enabled.

The **Event** filter has seven filter modes:

- Show events from specific sources only.
- Do not show events from specific sources.
- Show specific events from specific sources only.
- Do not show specific events from specific sources.
- Show specific types only.
- Do not show specific types.
- Show events where the source- or the description field matches a user specified text string only.

Choose the desired event filter mode and touch the **Specify** button in order to select the specific sources and events.



The test start event (Started) and stop event (Stopped) are always shown in the event log.

The **View** setting applies a port filter. A single port or all ports can be selected. Events with no port association will always pass.

The **CSV export** button is for writing all events (un-filtered) to a file in a CSV format (Comma Separated Values). The separator used can be configured in the **Instrument Toolbar > Configuration > General** menu screen, under **Miscellaneous**. It is not possible to export the file during a test.

The event log list

The events are displayed in a scrollable table. The content of the seven columns are:

No.

The index in the log.

Time

The time when the event was detected.

Port

Port number for events related to a port. Otherwise this field is blank.

Type

Event type icon.

- Alarm events are indicated by a red icon.
- Error events are indicated by a yellow icon.
- Threshold events are indicated by either a red or yellow icon with a T in the middle.

Src.

The source of the event. This row denotes the originating interface/technology or application.

Description

The event description. The alarms and errors in this column match those found in the **Statistics** screen.

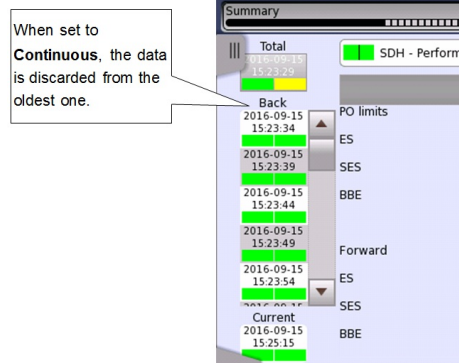

If "Memory for Statistics reached full!" is displayed, data is handled depending on the Memory allocation setting.

- **Use all storage:** Once the memory is full, the measurement stops. No data is discarded.
- **Continuous:** The measurement continues even if the memory is full. The saved data will be discarded from the oldest one. (Refer to left figure).

If "Event Log reached full!" is displayed, outputting the event stops. No event later than that will be recorded in the log.

Dur./Count

For alarms, this is the alarm duration measured in seconds. An alarm event where the duration is not know yet, will show the text **On**.

For errors, this is the number of errors in the errored second.

Event log and statistics can show different alarm duration and error count when values are summed up and compared. This is because statistics discards the last interval if it is not complete when the test is stopped. There will be no differences if the test duration is set to a multiple of the interval length or if intervals are disabled.

5.9.3.4 Statistics

Touching the **Statistics** button in the navigation area displays the screen shown below.

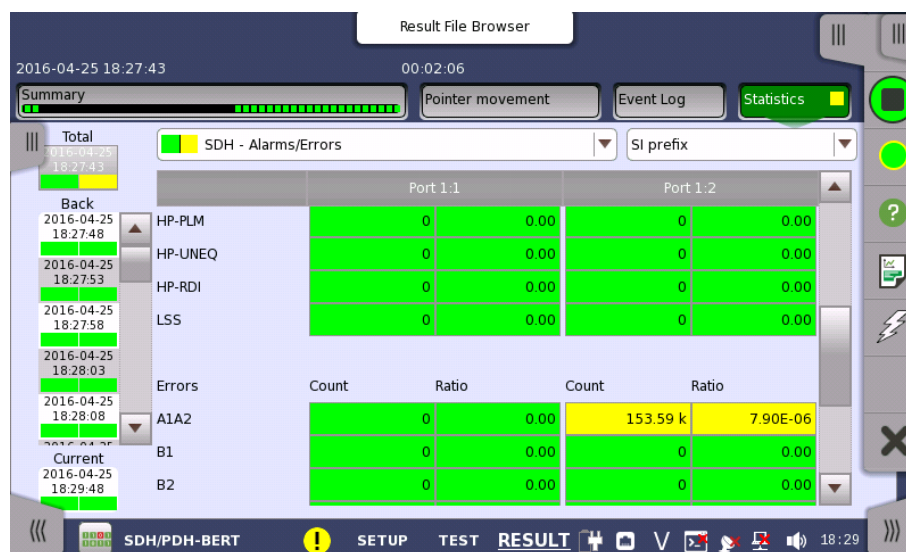

This screen presents a detailed analysis of the test results. You can choose to view either the total results from measurement start or the results of a specific interval during the test. You can also zoom in on a specific result item. The results can be displayed either in table (list) form or as a graph.

Selecting which results to view

Selecting the interval time

Touch the **Total** button to switch the total values measured in all interval times. The start time of measurement is displayed on the button.

Touching the button in left side **Back** field shows the measured values in the interval time. The end time of the interval is displayed on the button.

Current button is displayed at left bottom when the measurement is running. Touching the **Current** button shows the measured values in the current interval time.

The slide-out panel on the left-hand side of the screen contains the following functions:

- Only show intervals that contains errors
- Time format

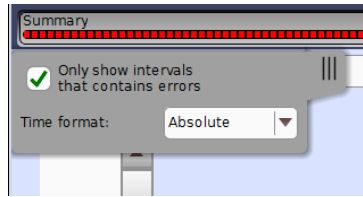

If you have stopped measurement during the interval time, the measurement results of the current interval are discarded. The log of the current interval is not displayed in **Back** field.

In this case, result data are re-calculated excluding the data of the current interval when the measurement is stopped. This causes that "Count" and "Ratio" displayed after the measurement will be different from that of during measurement.

The sum of interval time (multiplied interval time by the number of back logs) may not match the differential time between displayed time at left top and right top after the measurement.

Selecting type of results

Open the middle drop-down menu in the top row of buttons to select which results you want to display on the screen.

OTN	SDH, SONET	E1, E3, E4, DS1/J1, DS3
Alarms/Errors Performance	Alarms/Errors Quality Performance TCM	Alarms/Errors Performance

OTN options appear if the SDH/SONET signal is carried by OTN.

Studying a specific result

Touch a specific cell in a result table to zoom in on the corresponding result item. The **Count** and **Ratio** fields are displayed on a **Zoom** tab page. A **Time vs. Statistics** tab page is also available. Touch the **Back** button to return to the statistics screen.

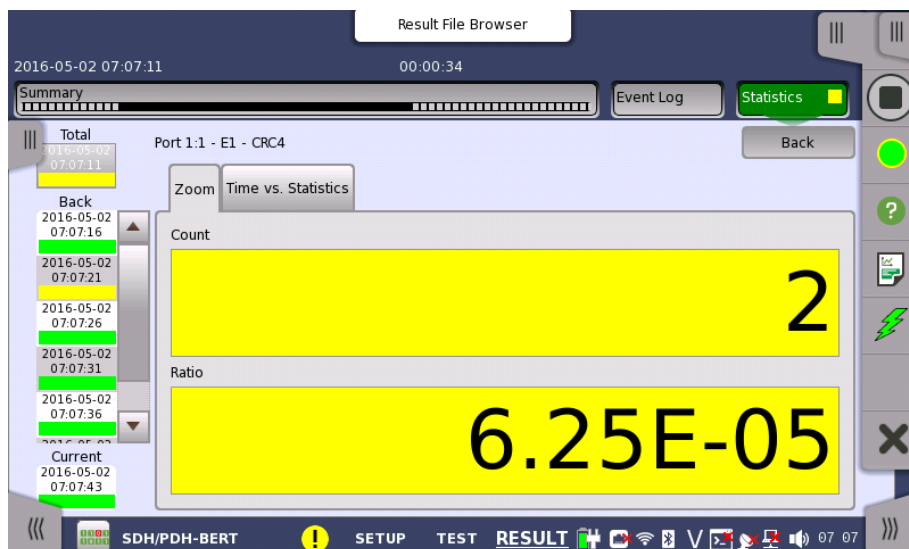

Selecting how results are displayed

Selecting notation

Select the required notation for the results from the notation drop-down menu.

- **Unformatted** - e.g. 71892
- **SI prefix** - e.g. 71.892 k (k means "kilo")

- **Engineering** - e.g. 71.892E3
- **Scientific** - e.g. 7.1892E4

Results

Results are displayed according to your choice. OTN appears when 'BERT on OTN' is running.

OTN Alarms/Errors	Refer to Results in "OTN Application"
OTN Performance	Refer to Results in "OTN Application"
SDH Alarms/Errors	Alarms Errors
SDH Quality	Frequency* ¹ MUX AU VC-4/3 TU VC-3 TU VC-12/11 Bulk AU Pointer TU Pointer Justification* ²
SDH Performance	Frequency* ¹ MUX AU VC-4/3 TU VC-3 TU VC-12/11
SDH TCM	Alarms Errors
SONET Alarms/Errors	Alarms Errors
SONET Quality	Frequency* ¹ MUX STS-3c/1 TU VC-3 VT-2/1.5 Bulk STS Pointer VT Pointer Justification* ²
SONET Performance	Frequency* ¹ MUX STS-3c/1 TU VC-3 VT-2/1.5
SONET TCM	Alarms Errors
E1 Alarms/Errors	Alarms Errors
E1 Performance	FAS errors Pattern errors CRC4 errors

	E-Bit errors *3
E3 Alarms/Errors	Alarms Errors
E3 Performance	FAS errors Pattern errors
E4 Alarms/Errors	Alarms Errors
E4 Performance	FAS errors Pattern errors
DS1/J1 Alarms/Errors	Alarms Errors
DS1/J1 Performance	FAS errors Pattern errors CRC-6 *4
DS3 Alarms/Errors	Alarms Errors
DS3 Performance	FAS errors Pattern errors

*1: Frequency results appear only when no OTN layer.

*2: **Justification** appears when 'PDH Rx' or 'DSn Rx' is selected.

*3: **E-Bit errors** appears when 'E-bit' is set to On in Frame tab of E1 receiver.

*4: **CRC6 errors** appears when 'ESF' or 'J1' is selected.

SDH/SONET Performance Measurement Items

This paragraph describes the performance result items.

EB (Errored Block) is defined as:

A block in which one or more errors occurred

SDH/SONET Performance Parameters

Items	Definition
ES	<p>Errored Second</p> <p>Count: The number of seconds during which one or more EBs occurred or one or more alarms were detected.</p> <p>Ratio: Ratio of ES to total seconds in availability time (ESR: Errored Second Ratio)</p>
SES	<p>Severely Errored Second</p> <p>Count: The number of seconds during which 30% or more EBs occurred or one or more alarms were detected.</p> <p>Ratio: Ratio of SES to total seconds in availability time (SESR: Severely Errored Second Ratio)</p>
BBE	<p>Background Block Error</p> <p>Count: EBs that occurred in non-SES.</p> <p>Ratio: Ratio of BBE to all blocks excluding blocks in SES (BBER: Background Block Error Ratio)</p>
UNAV	<p>Unavailable Time</p> <p>When SES continues for ten seconds, UNAV starts from the beginning of the time. When items other than SES occur, UNAV ends at one second before the time.</p>

The following is the alarms which are counted as ES or SES:

SDH

MS-AIS, MS-RDI, AU-AIS, AU-LOP, HP-TIM, HP-UNEQ, HP-RDI, TU-AIS, TU-LOP, LP-TIM, LP-UNEQ, LP-RDI

SONET

AIS-L, RDI-L, AIS-P, LOP-P, TIM-P, UNEQ-P, RDI-P, AIS-V, LOP-V, TIM-V, UNEQ-V, RDI-V

When the standard of Performance Parameters is set to G.826 or G.828+G829, PO (Performance Objective) limit is displayed for ES, SES, and BE respectively. PO limit is the calculated value by multiplying allocation in Performance Parameters by the Performance Objective defined in ITU Recommendation. When the measured value is equal to, or less than PO limit, the result is judged as Pass.

When the standard of Performance Parameters is set to M.2101.1, BIS (Bringing-Into-Service) limit is displayed as the Performance Objective.

BIS limit

Items	Definition
S1-ES	The ES threshold for deciding Accepted
S2-ES	The ES threshold for deciding Unaccepted
S1-SES	The SES threshold for deciding Accepted
S2-SES	The SES threshold for deciding Unaccepted

S1-ES, S2-ES, S1-SES, and S2-SES are the calculated values according to ITU Recommendation, and vary depending on Allocation and Period of Performance Parameters. When the measured ES value is equal to or less than S2-ES or the measured SES value is equal to or less than S2-SES, the result is judged as Pass.

PDH Performance Measurement Items

This paragraph describes the performance result items. Measurement time definitions are as below.

S_{Total}

Total measurement time. This is the total time of the measurement excluding the time of power failure.

S_{Avail}

Available time of measurement. Calculated from the following formula:

$$S_{Avail} = S_{Total} - S_{Unavail}$$

$S_{Unavail}$

Unavailable time of the measurement. Refer to UAT definition.

Performance Parameters

Items	Definition
ES	Errored Second Within S_{Avail} , the number of seconds during which one or more errors occurred.
SES	Severely Errored Second Within S_{Avail} , the number of seconds during which any of the following is detected. <ul style="list-style-type: none"> • 10^{-3} or more errors • AIS • LOS
BBE*	Background Block Error Within S_{Avail} , the number of errors during which SES is not detected.
ALS	Alarm Second Within S_{Avail} , the number of seconds during which any of the following is detected. <ul style="list-style-type: none"> • AIS • LOS
UAT	Unavailable Time When SES or ALS continues for ten seconds, UAT starts from the beginning of the time. When items other than SES continues for ten seconds, UAT ends at one second before the time. Refer to the figure of Example of Unavailable Time Detection . First, the time (when determining the start of UAT) is not counted as UAT, and then if determined, the UAT is recounted. First, the time (when determining the end of UAT) is counted as UAT, and then if determined, the UAT is recounted. In a word, the values of UAT may be reduced later. The same is applied to other items.
AVT	Available Time The available time of the measurement $S_{Avail} = S_{Total} - S_{Unavail}$
EFS	Error Free Second Within S_{Avail} , the number of seconds during which no errors occurred.

*: Appears when the standard of Performance Parameters is set to G.826.

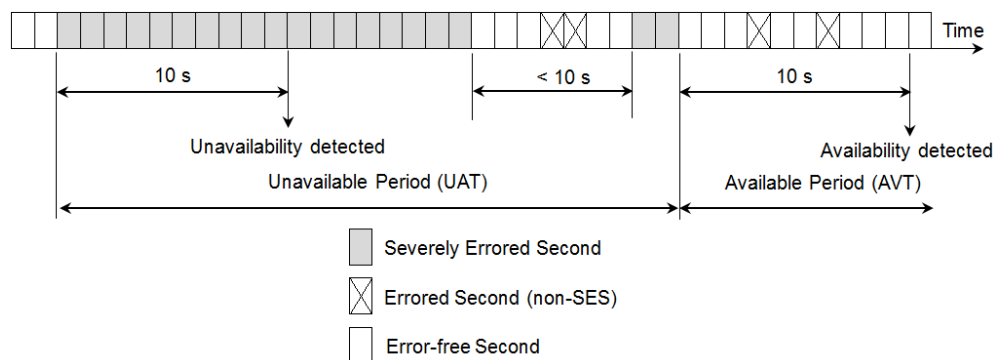

Example of Unavailable Time Detection

The performance objectives defined in ITU Recommendation are shown in the following table. When the measured value is equal to or less than these values, the cell is displayed in green.

Performance Objectives

Items	G.821	G.826	M.2100
ES Ratio	0.08	0.04	0.02
SES Ratio	0.002	0.002	0.001

5.10 RTD



The Round-Trip Delay (RTD) test measures the time that the data which is transmitted by the transmitter returns to the receiver.

The RTD test described in this section is applicable for SDH/SONET/PDH/DSn interfaces.

For RTD test of OTN interface, refer to [RTD](#) in "OTN Application".

5.10.4 Ports Setup and Status

The first step in running an application is to set up the port interfaces. This is done on the **Ports Setup** screen, which also provides port status information.

The setup options and status information related to each interface type are described in separate sections:

- [SDH Setup and Status](#)
- [SONET Setup and Status](#)
- [E1 Setup and Status](#)
- [DS1/J1 Setup and Status](#)
- [E3 Setup and Status](#)
- [DS3 Setup and Status](#)
- [E4 Setup and Status](#)
- [OTN Setup and Status](#)

Please refer to the sections relevant for your current port setup requirements.

5.10.5 Test Setup

5.10.5.1 Control

When you go to the test setup of the RTD application, the following screen is displayed.

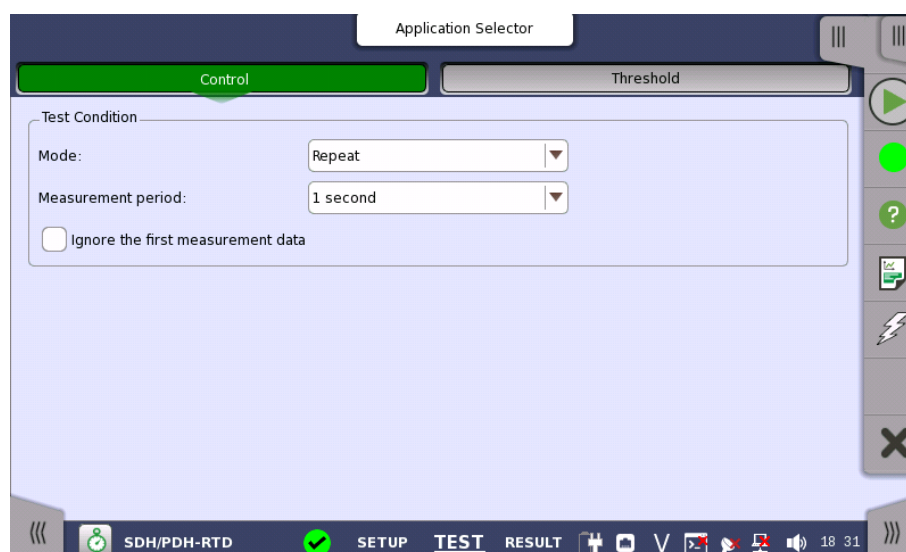

This screen allows you to configure the RTD test conditions for the currently selected port(s).

Test Condition Allows you to define the test duration in one of two ways:

Mode

- **Single** - Used to perform RTD test once.
- **Repeat** - Used when a *persistent RTD test* is needed.

Measurement period

Select the measurement period from **0.5 seconds** to **10 seconds**.

5.10.5.2 Threshold

Touching the **Threshold** button in the navigation area displays the following items.

Threshold

Maximum limit

Allows you to specify a threshold value of RTD in micro seconds (μs).

5.10.6 Test Results

5.10.6.1 Summary

Touching the **Summary** button in the navigation area will display the screen shown below.

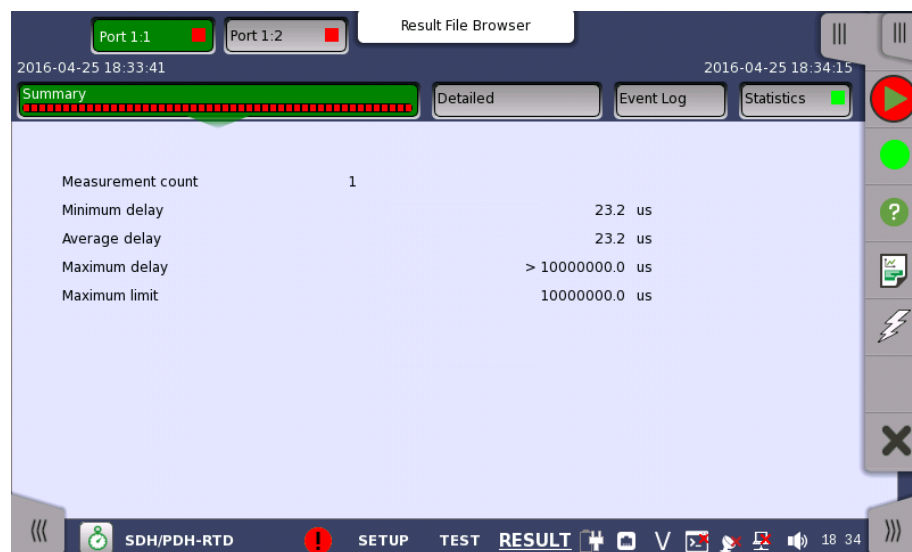

This screen presents a summary of the RTD test results, for all of the ports included in the test. For each port, the information consists of:

- Measurement count
- Minimum, average, and maximum round-trip delay times in micro seconds
- Threshold value

5.10.6.2 Detailed

Touching the **Detailed** button in the navigation area will display the screen shown below.

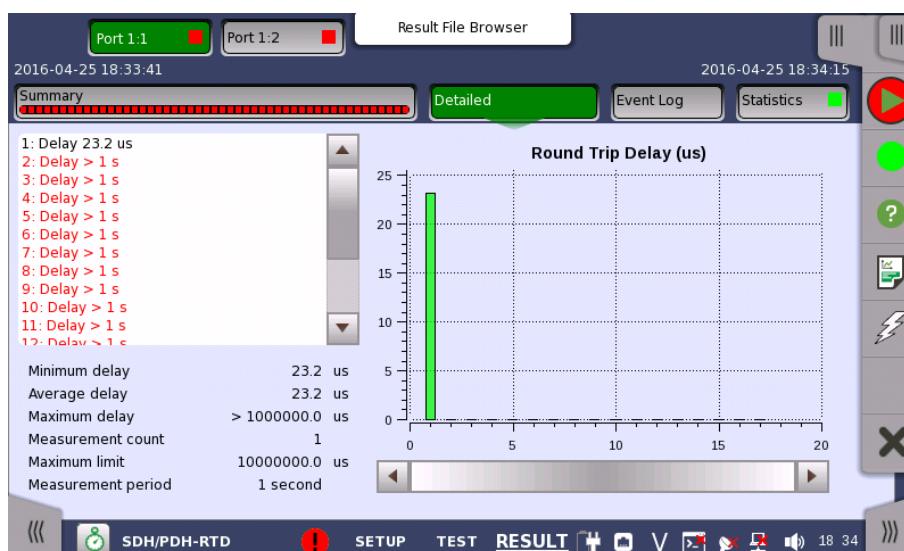

Buttons for selecting the relevant port are displayed at the top of the screen, with a color indication of the pass/fail status of the test.

This screen presents the detailed results of an RTD test. The result is shown in both list-form and in a graphical presentation. This screen contains the summary field displayed below the list.

Summary field

Consists of the minimum, average, and maximum round-trip delay times in microseconds, the number of measurements, the specified threshold value and measurement period.

List-form information

Presents the results of an RTD test in list-form.

Graphical presentation

The graphical presentation consists of a bar diagram of the round-trip delay times.

5.10.6.3 Event Log

Touching the **Event Log** button in the navigation area displays the screen providing the event log data. Refer to [Event Log](#) of SDH/SONET/PDH/DSn BERT application.

5.10.6.4 Statistics

Touching the **Statistics** button in the navigation area displays the screen providing the statistics data. Refer to [Statistics](#) of BERT for the operation.

6 Ethernet Applications

This chapter describes the graphical user interface (i.e. screens, sub-screens and major dialogs) related to Ethernet applications. Sub-screens and dialogs are described under the main screen from which they are activated/launched.

The following setting and applications are available:

- [Ethernet Setup and Status](#)
- [BERT](#)
- [Cable](#)
- [Channel Statistics](#)
- [Mon/Gen](#)
- [Pass Through](#)
- [Ping](#)
- [Reflector](#)
- [RFC 2544](#)
- [RFC 6349](#)
- [SAT 1564](#)
- [Traceroute](#)
- [Sync Test](#)
- [Discovery](#)

6.1 Ethernet Setup and Status

Ethernet is globally used for data communication. Ethernet transmits variable length frames up to 1500 bytes in length, each containing a header with the source and destination addresses and a trailer that contains error correction data.

When setting an Ethernet application on OTN, in the navigation area of the [Ports Setup](#) screen, the Ethernet layer may initially be shown as a single **Ethernet** button which will change into a row of buttons when you touch it. Each button represents an aspect of Ethernet port setup and gives you access to the related setup options.



The Ethernet interface uses the Electrical RJ45 connectors or the optical ports.



MU100010A Connector Panel

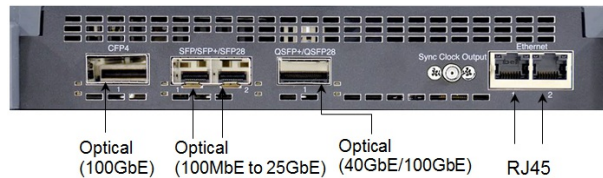

MU100011A Connector Panel

6.1.1 Physical Port Setup

When the port is set up with an Ethernet interface, touching the **Port** button in the navigation area will display the following screen.

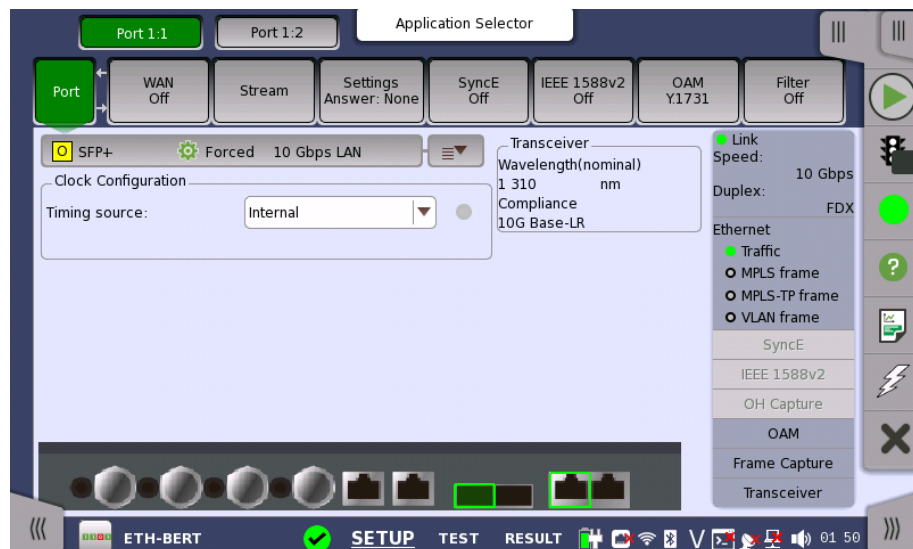

This screen allows you to specify the physical port configuration of the currently selected [Ethernet](#) port. It can also be used to inspect the current status of the selected port.

The configuration options available in the setup area of the screen are described below. The status information is described in a separate section.

6.1.1.1 Port configuration parameters

Port definition

You can use either a 'quick mode' or a 'detailed mode' to set up the port. Touching the long button at the top of the setup area will launch the [Port Setup](#) dialog box. Touching the right part of the button () will open the *quick setup menu*.

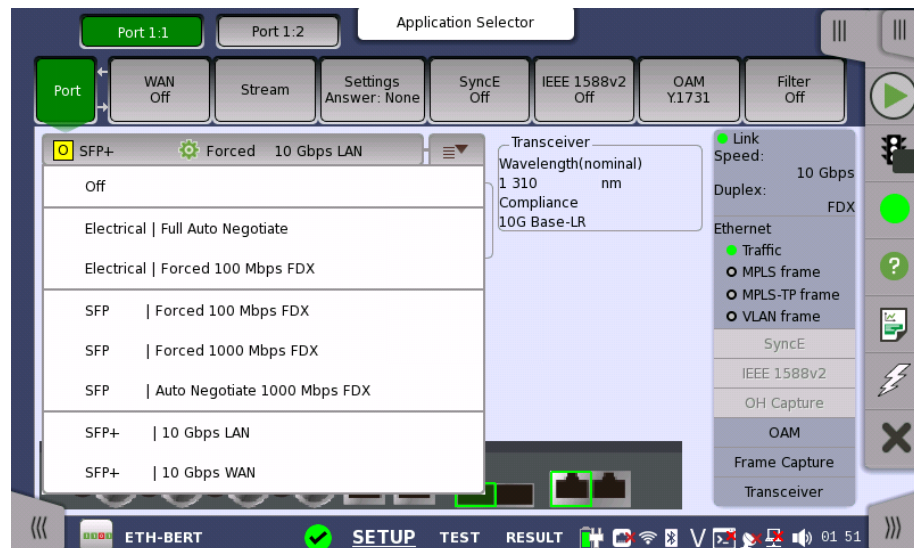

The quick setup menu contains a number of predefined port configurations (e.g. **Electrical | Forced 100 Mbps FDX**). The detailed mode dialog allows you to specify the configuration yourself.



The detailed mode (**Port Setup**) dialog box is described in a separate section below.

Clock Configuration

Timing source

Select a source to synchronize all Ethernet transmitters to.

The possible sources are:

- Internal
- External
- GPS
- Received
- IEEE 1588v2

Received appears when the interface type is set to SFP, SFP+, SFP28, QSFP+, QSFP28 or CFP4

IEEE 1588v2 appears when the interface type is set to Electrical SFP, or SFP+.

Sync Port

This item appears when using MU100011A and Interface Type is set to SFP28, QSFP28 or CFP4. Selects the output of Sync Clock Output connector on MU100011A panel.

- Off: does not output the clock.
- 1/8: outputs 1/8 divided clock of the data synchronized clock (approximately 3.222 GHz).
- 1/16: outputs 1/16 divided clock of the data synchronized clock (approximately 1.611 GHz).

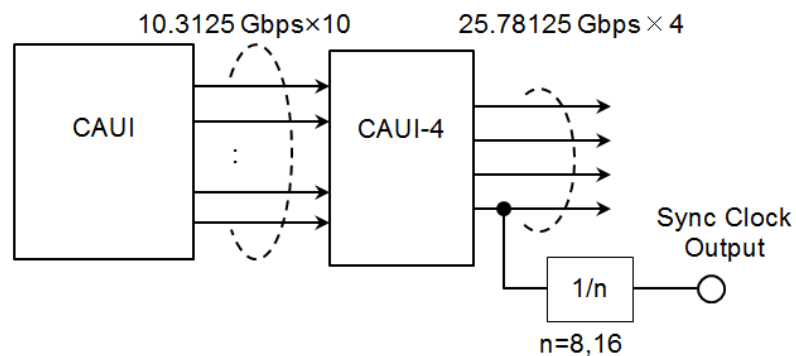

Block Diagram of MU100011A Tx Part (QSFP28, CFP4)

FEC

FEC enable

This setting appears when using MU100011A and Interface Type is set to SFP28, QSFP28 or CFP4.

- On: The calculated forward error correction data will be added to the 25G Ethernet frame and the 100G Ethernet frame.
- Off: FEC is not added to the 25G Ethernet frame and the 100G Ethernet frame.

Transceiver

Displays the Transceiver information.

Multi lane mapping

In case of 40G or 100G interface, touching the Lane Mapping button launches the following dialog box.

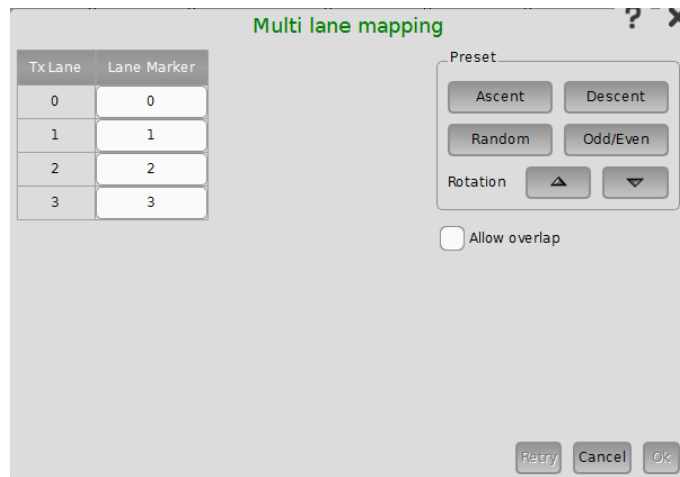

The number of lanes depends on the interface type. Touching **Lane Marker** field allows to set the PCS lane marker.

Use buttons in **Preset** frames to preset the lane markers.

Allow overlap

If check box is selected, you can set overlapped number to the lane marker.

6.1.1.2 Port Setup (detailed mode)

The contents of the dialog box (i.e. which parameters are displayed) depends on your combined choice of *interface type* and *port mode*.

MU100010A

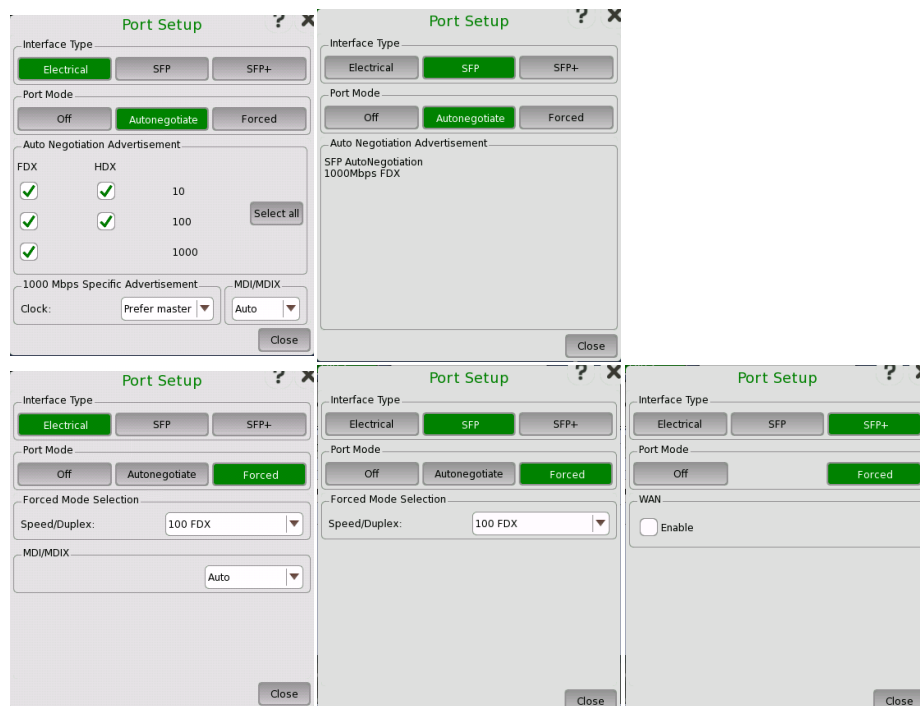

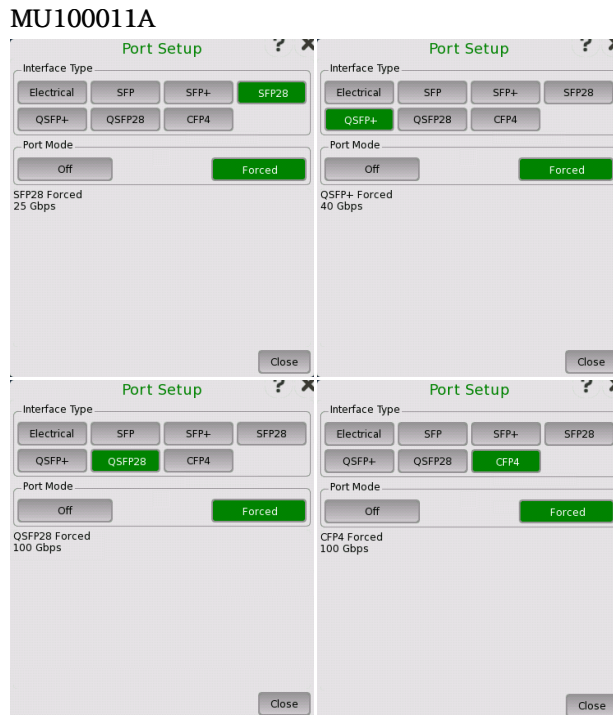

Port Mode = Off

Selecting the **Off** port mode will shut down the Ethernet port and stop the physical link.

Electrical + Autonegotiate

Selecting the **Autonegotiate** port mode with interface type specified as **Electrical** will display the following parameters:

Auto Negotiation Advertisement

Allows you to set the speed and duplex capabilities that are advertised to the link partner.

- **FDX** can be set to **10**, **100** and **1000**.
- **HDX** can be set to **10** and **100**.

Using the **Select all** will automatically set check marks in every check box.

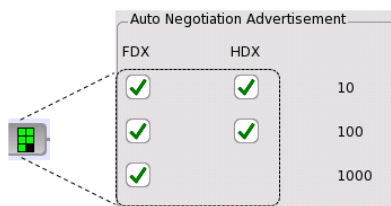

The selected negotiations are indicated by the icon on the button.

1000 Mbps Specific Advertisement

Open the **Clock** drop-down menu to select one of the following settings:

Prefer master, Prefer slave, Master, or Slave.

MDI/MDIX

Set the pin assignment of the electrical port.

- **Auto** sets the pin assignment of the Network Master electrical port to MDI or MDIX automatically.
- **MDI** sets the electrical port to Medium Dependent Interface. Pin 1 and 2 of the electrical port on Network Master are used for the transmission, pin 3 and 6 are used for the reception.

- **MDIX** sets the electrical port to Medium Dependent Interface Crossover. Pin 3 and 6 of the electrical port on Network Master are used for the transmission, pin 1 and 2 are used for the reception.

Selecting **Auto** allows the Network Master to communicate not depending on the LAN cable type (straight cable or cross cable) connected to the DUT.

Electrical + Forced

Selecting the **Forced** port mode with interface type specified as **Electrical** will display the following parameters:

Forced Mode Selection

Allows you to select the forced mode speed and duplex capabilities. Available choices are:

10 HDX, 10 FDX, 100 HDX, and 100 FDX



When autonegotiating with a port that is forced (i.e. not using autonegotiation), the duplex for the port that is using autonegotiation will automatically be set to Half Duplex (HDX) and the speed to the speed used by the forced port. It is thus possible to have a duplex mismatch without knowing it.

MDI/MDIX

Set the pin assignment of the electrical port.

- **Auto** sets the pin assignment of the Network Master electrical port to MDI or MDIX automatically.
- **MDI** sets the electrical port to Medium Dependent Interface. Pin 1 and 2 of the electrical port on Network Master are used for the transmission, pin 3 and 6 are used for the reception.
- **MDIX** sets the electrical port to Medium Dependent Interface Crossover. Pin 3 and 6 of the electrical port on Network Master are used for the transmission, pin 1 and 2 are used for the reception.

Selecting **Auto** allows the Network Master to communicate not depending on the LAN cable type (straight cable or cross cable) connected to the DUT.

SFP + Autonegotiate

Selecting the **Autonegotiate** port mode with interface type specified as **SFP** will display the negotiated speed.

Only 1000Mbps FDX is supported by Autonegotiate function.

SFP + Forced

Selecting the **Forced** port mode with interface type specified as **SFP** allows you to select the forced mode speed. Available choices are:

100 FDX, 1000 FDX

SFP+

When running 10G only **Forced** mode is available.

WAN

Select the **Enable** check box to enable insertion of the WAN interface sublayer (WIS).



WAN interface sublayer is available for BERT application only.

SFP28

Only **Forced** mode is available.

QSFP+

Only **Forced** mode is available.

QSFP28

Only **Forced** mode is available.

CFP4 Only **Forced** mode is available.

6.1.2 Ethernet Frame Setup

6.1.2.1 WAN

Touching the **WAN** button in the navigation area will display the screen shown below.

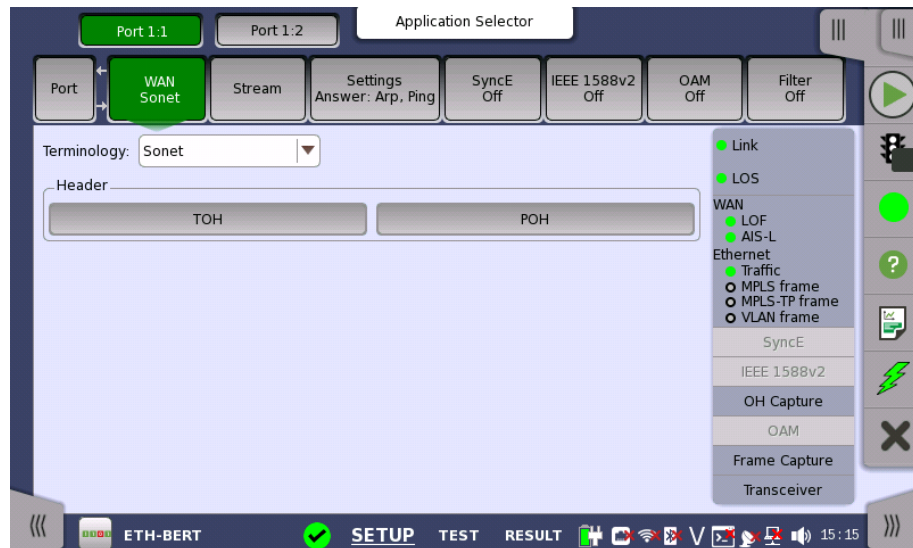

This screen allows you to specify the configuration of a WAN interface sublayer for the currently selected Ethernet port. It can also be used to inspect the current status of the selected port.

The configuration options available in the setup area of the screen are described below. The status information is described in a separate section.

Terminology

Allows you to select either **Sonet** or **SDH** notation for the naming of alarms, errors, and pointers on the WAN status and result pages.

Follows

It is possible to let the Port 2 copy the setup from Port 1 by touching the **Follow** button. When this button is displayed in green, Port 2 continues to follow Port 1 change. This button appears when the Port 1 settings can be copy to Port 2.

Header

The buttons varies depending on "Terminology" selection. Touching the buttons launches the dialog box to set **SOH**, **TOH** or **POH**.

- SOH (Section OverHead) for SDH
- TOH (Transport OverHead) for Sonet
- POH (Path Overhead)

For the operation of dialog boxes, refer to the following sections.

[SOH Editor](#) in "SDH Setup and Status"

[POH Editor](#) in "SDH Setup and Status"

[TOH Editor](#) in "SONET Setup and Status"

[POH Editor](#) in "SONET Setup and Status"

6.1.2.2 Streams

Touching the **Streams** button in the navigation area will display a screen like the one shown below.

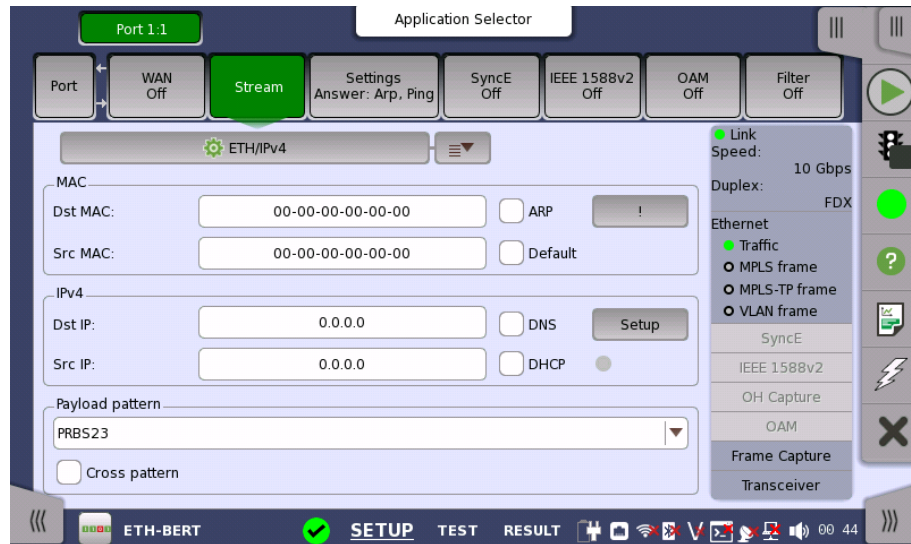

This screen contains the setup of the Ethernet frame content transmitted by the Network Master. The exact layout depends on the current selection of layers (i.e. the various encapsulation and protocol headers composing the Ethernet frame). Touching the button in the top left-hand part of the screen will display the dialog box to set options related to the layers.

Only the most important (i.e. most frequently used) configuration parameters are displayed here for each specified layer. To access all parameters, launch the frame composition 'Stream Setup' dialog box accessible via the button in the top left-hand part of the screen.

Composing the Ethernet frame

The following headers/layers are available for the frame configuration:

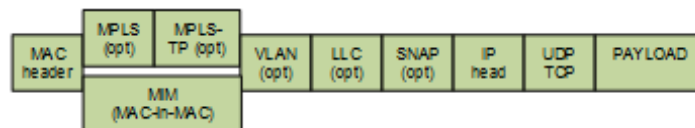

You can use either a 'quick' mode or a 'detailed' mode to set up the selection of headers/layers. Touching the button at the top of the setup area will launch the *detailed mode* dialog box (the [Stream Setup dialog box](#)). Touching the arrow to the right of the button will open the *quick selection menu*.

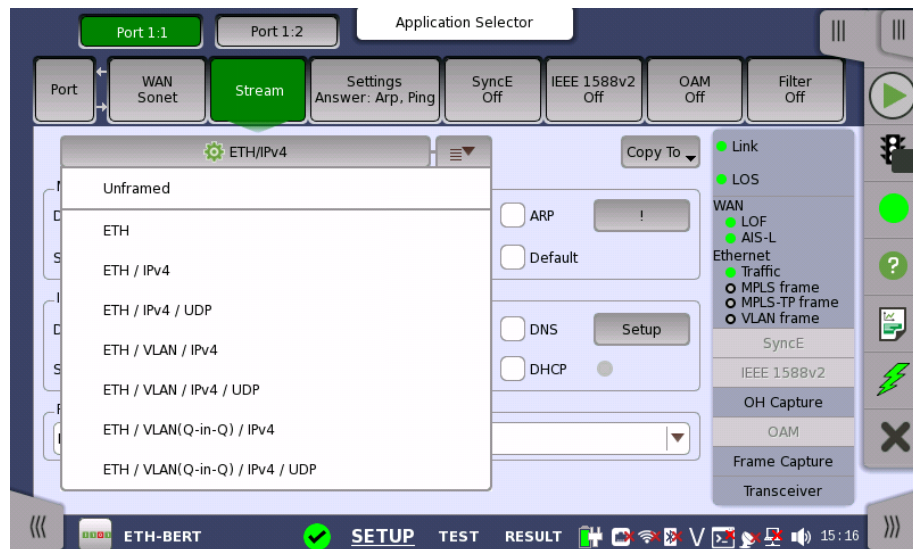

The quick selection menu contains a number of predefined frame configurations (e.g. **ETH/VLAN/IPv4**). The detailed mode dialog box allows you to specify the frame configuration yourself and also provides you with access to all configuration parameters available for the individual layers.

The detailed mode (**Stream Setup**) dialog box is described in detail below.

Follow another port



It is possible to let the Port 2 copy the setup from Port 1 by touching the **Follow** button. When this button is displayed in green, Port 2 continues to follow Port 1 change. This button appears when the Port 1 settings can be copy to Port 2.

Multistreams

Multistream setup is available in the following applications.

- Mon./Gen.
- SAT 1566
- Channel Stat.

When the Multistream is active, the screen contains a **Stream** slide-out, which allows you to select the relevant stream to view/configure. The name of the slide-out control indicates which stream is currently being displayed.

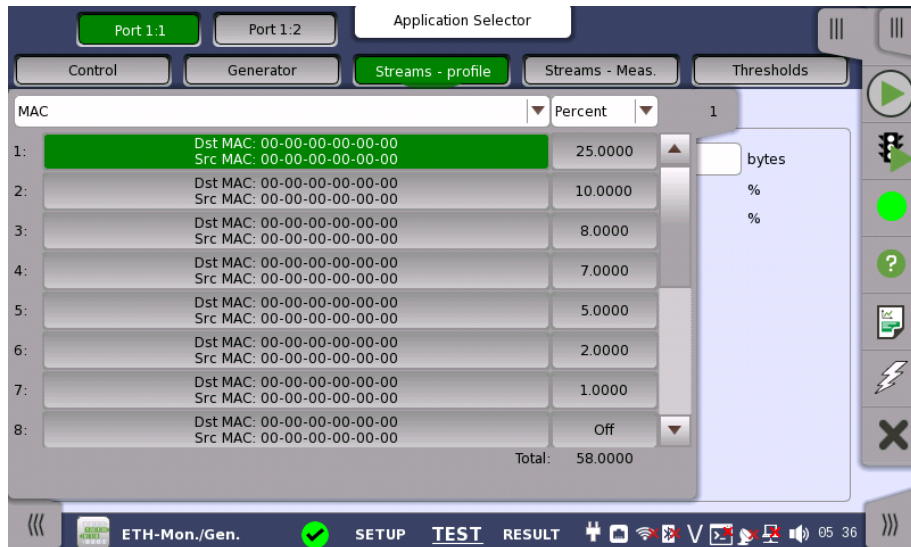

At the top of the slide-out list you can switch between MAC, IP, and VLAN information as stream identification.

Copy frame content to other stream(s) This feature allows you to copy the frame content of the stream that you are currently configuring to all streams in another port or to a single stream.

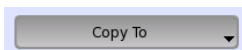

Touching the **Copy To** button opens a drop-down menu from which you can select the relevant port and all or a specific stream.

If selecting **All streams**, All Streams Copy dialog box appears.

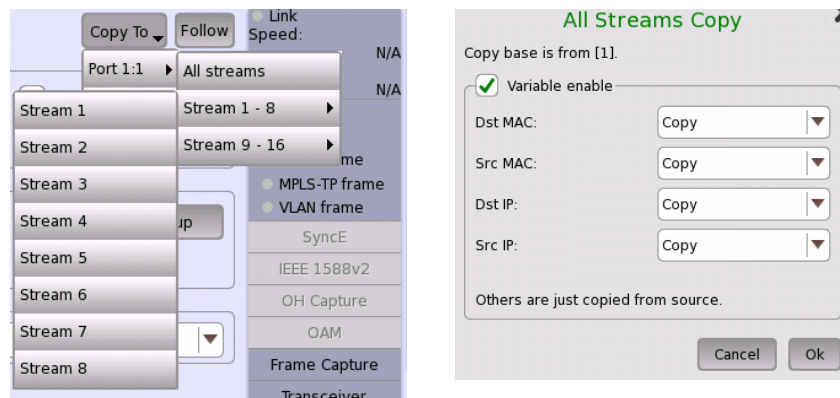

When copying settings to all streams, it is available to change MAC or IP address with selecting **Variable enable** check box. If the check box is not selected, same address is copied to all streams.

It takes a few moments to copy settings to all streams.

Change range is:

LSB 8 bits for MAC address and IPv4 address

LSB 16 bits for IPv6 address

Example is shown below:

When copied MAC address by setting with Decrement	When copied IPv6 address by setting with Increment
00-00-00-00-00-04	0000:0000:0000:0000:0000:0000:FFFF:FFFC
00-00-00-00-00-03	0000:0000:0000:0000:0000:0000:FFFF:FFFD
00-00-00-00-00-02	0000:0000:0000:0000:0000:0000:FFFF:FFFE
00-00-00-00-00-01	0000:0000:0000:0000:0000:0000:FFFF:FFFF
00-00-00-00-00-00	0000:0000:0000:0000:0000:0000:FFFF:0000
00-00-00-00-00-FF	0000:0000:0000:0000:0000:0000:FFFF:0001
00-00-00-00-00-FE	0000:0000:0000:0000:0000:0000:FFFF:0002
00-00-00-00-00-FD	0000:0000:0000:0000:0000:0000:FFFF:0003
:	:

Stream Setup (detailed mode dialog box)

This dialog box provides you with the advanced options for configuring the Ethernet frame content for a specific stream. Use the buttons in the following figure to select the stream.

The buttons on the left-hand side of the dialog box allow you to select the relevant layers. The current selection is shown at the top of the **Frame Content** area. Touching one of the layer buttons in the **Frame Content** area will display the setup parameters for that layer.

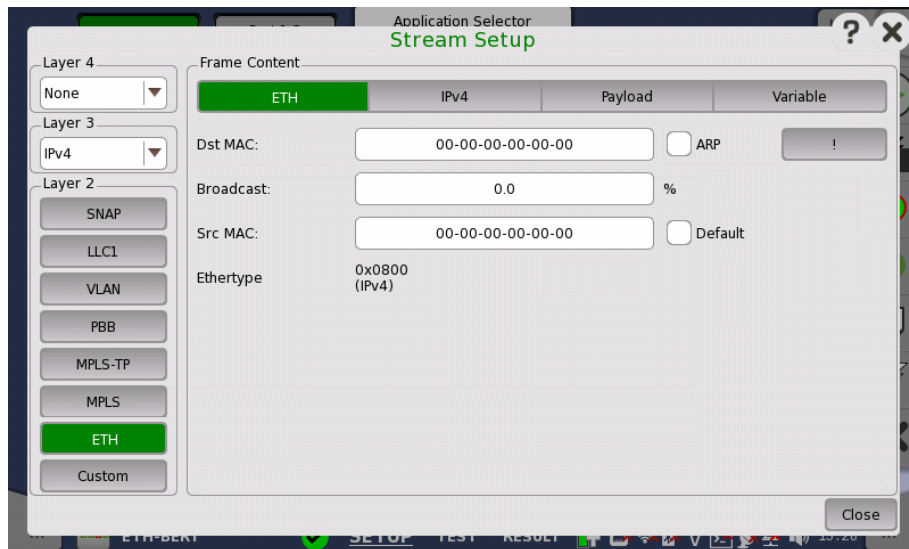

The layer buttons are arranged in order from bottom to top and from left to right. The TCP/UDP protocols are the uppermost layer and Ethernet the lowermost as depicted below compared to the OSI model.

#	OSI layer name	Protocol
4	Transport	TCP, UDP
3	Network	IPv4 ⁽¹⁾ , IPv6 ⁽¹⁾ , ICMP ⁽²⁾ , ARP
2	Data Link	IEEE 802.2 LLC Type 1/ LLC1 + SNAP ⁽¹⁾ , VLAN ⁽¹⁾ , PBB, MPLS-TP, MPLS, Ethernet ⁽¹⁾
1	Physical	Electrical / SFP / SFP+, 10 Mbps / 100 Mbps / 1000 Mbps / 10 Gbps, FDX / HDX
<p>(1) Protocols can be excluded and the content changed.</p> <p>(2) ICMP appears in case of Ping application.</p>		



Encapsulation affects the Ping and RFC2544/Router Latency test, i.e. Ping replies will only be sent if the Ping request contains the same encapsulation as the one selected.

Touching **Close** will save your current settings and close the dialog. The settings done in dialog box will be reflected on the ports setup screen.

Layer configuration parameters

The settings related to each layer are described in detail below. The following layer buttons are available:

- [Custom](#) (Custom header)
- [Unframed](#)
- [ETH](#) (MAC header)
- [MPLS](#)
- [MPLS-TP](#)
- [PBB](#)
- [VLAN](#)
- [LLC1](#)
- [SNAP](#)
- [IPv4](#)
- [IPv6](#)
- [UDP](#)
- [TCP](#)
- [Payload](#)
- [Variable](#)

Custom

Custom header can be set on BERT application, allows users to edit the specific area in the header. To set Custom header, touch the **Custom** button in Layer 2 or select **Custom** in Layer 3.

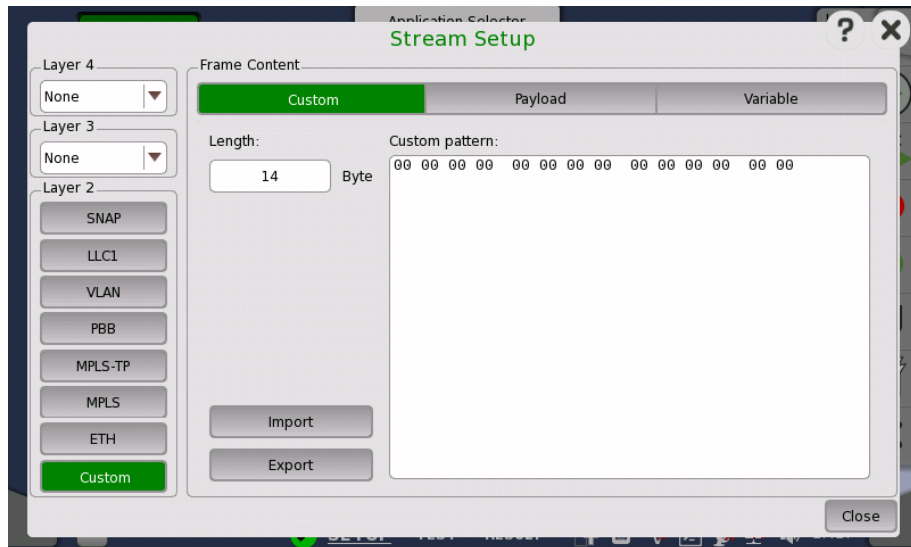

Custom appears for BERT application only.

Length

Touch the field to set header length in bytes. The bit pattern with the specified length appears in the **Custom pattern** field.

Touching the **Custom pattern** field launches the Pattern Editor similar to that of dialog box.

To add the header corresponding to Ethernet header, enter 14 in Layer 2 Custom header.

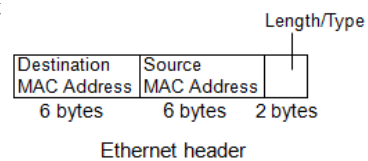

To add the header corresponding to IPv4 header, enter 20 in layer 3 Custom header.

Be sure to set **Ethertype** in **ETH** layer.

Import

Touching this button launches the **Import Custom Header** dialog box. Select the header file (*.txt), and touch **Import** button.

Export

Touching this button launches the **Export Custom Header** dialog box. Enter the file name and touch **Export** button.

Unframed

Following operation on Steam Setup dialog box will display the parameter of the unframed stream. The frames of Unframed stream do not contain MAC header, but are consisted from the preamble and the payload pattern.

- Touching the **ETH** button on green in Layer 2
- Touching the **Custom** button on green in Layer 2

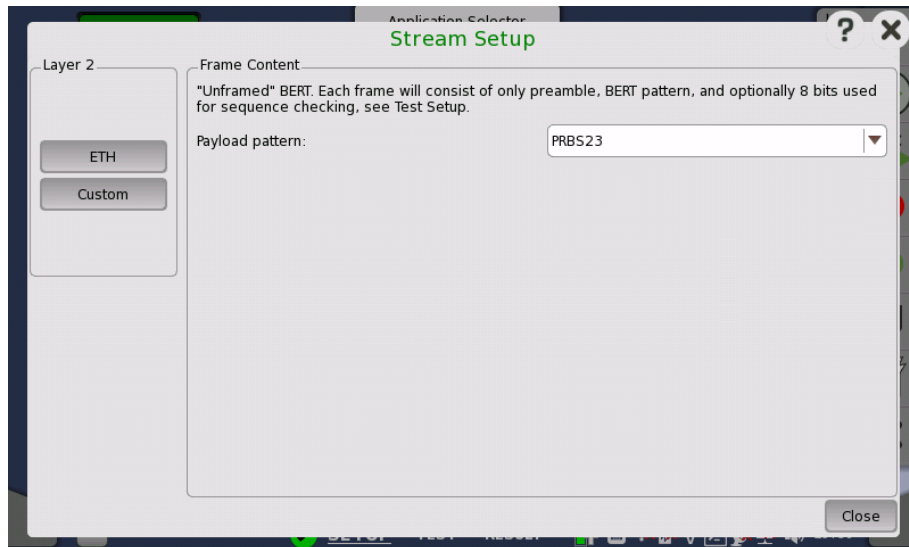

Custom button appears for BERT application only.

Frame Content

Touch the **Payload patten** field to set the pattern for the bit error rate test. Each frame consists of only preamble and payload pattern.

One byte for the sequence check will be appended by selecting **Enable sequence checking** on [Stream](#) screen of Test Setup.

ETH

Touching the **ETH** layer button displays the parameters available for the Ethernet header.

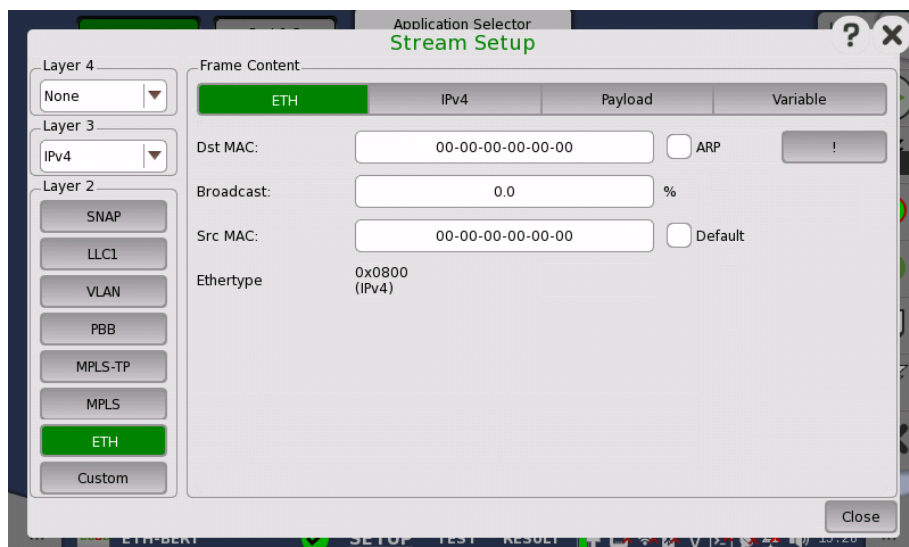

The Ethernet (MAC) header contains MAC addresses and Ethertype.

Dst MAC

The *Destination MAC address* can either be specified manually. This can be decided based on an ARP lookup when IPv4 is set to Layer 3 or based on an NDP when IPv6 is set to Layer 3.

To enable ARP or NDP, select the **ARP** check box or the **NDP(NS/NA)** check box to the right of the **Dst MAC** field.

The ! button is an *instant* button which when touched will perform an ARP or NDP lookup immediately, instead of waiting until the transmitter starts.

Broadcast

The *Broadcast Share* control is used to set the ratio between Unicast and Broadcast frames transmitting.

Src MAC

The *Source MAC address* can be specified manually, but the instrument comes with a default unique MAC address for each port.

If the **Default** check box is selected, the default unique MAC address is used.

Ethertype

When **IPv4** or **IPv6** is set to Layer 3, the Ethertype is automatically defined, based on the next protocol element. When **None** is set to Layer 3, it can be set between 0x05DD to 0xFFFF.

MPLS

Touching the **MPLS** layer button displays the parameters available for the MPLS protocol layer.

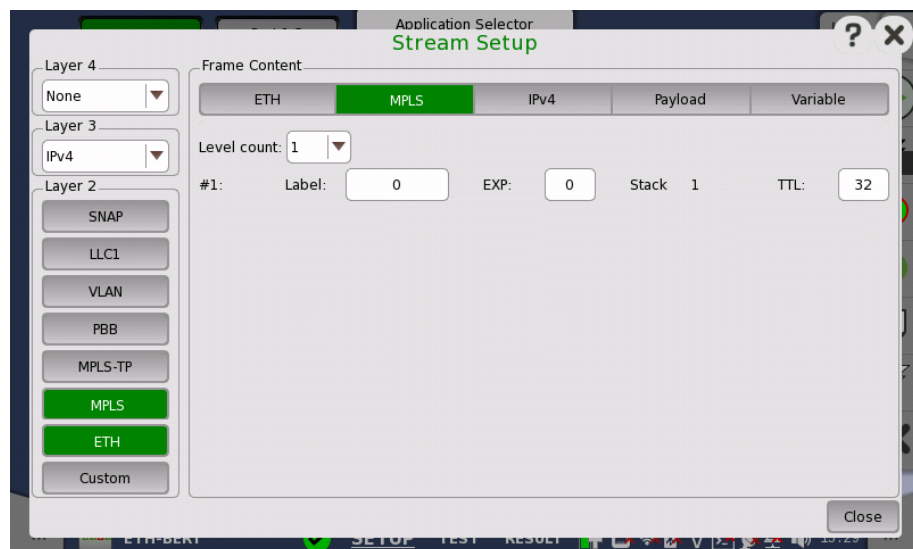

Level count

Up to eight levels of MPLS fields can be inserted in the frame. The number of MPLS fields is selected through the **Level count** drop-down menu, and each level is set up individually.

Label

Allows you to set up a denoting of the MPLS.

EXP

Allows you to set up the 3 bit value EXP (Experimental - used in MPLS to support differentiated services (priority)).

TTL

Allows you to set up the 8 bit value TTL (Time To Live).

MPLS-TP

Touching the **MPLS-TP** layer button displays the parameters available for the *MPLS-TP* protocol layer.

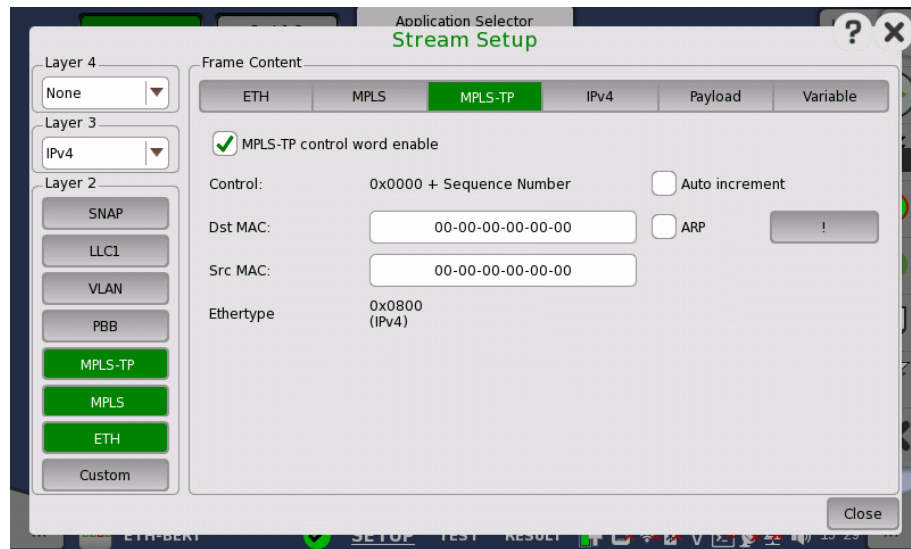
**MPLS-TP control word enable**

When selecting the check box, a control word will be inserted in the frame.

Auto increment

Selecting the **Auto increment** check box makes the sequence number in the RFC4448 control word increment automatically instead of being fixed to zero.

The remaining fields are described under the [ETH](#) layer.



*When MPLS-TP is active the **ARP** button and **NDP(NS/NA)** button will be moved away from the [ETH](#) layer.*

PBB

Touching the *PBB* layer button displays the parameters available for the Provider Backbone Bridges (*MAC-in-MAC*) header.

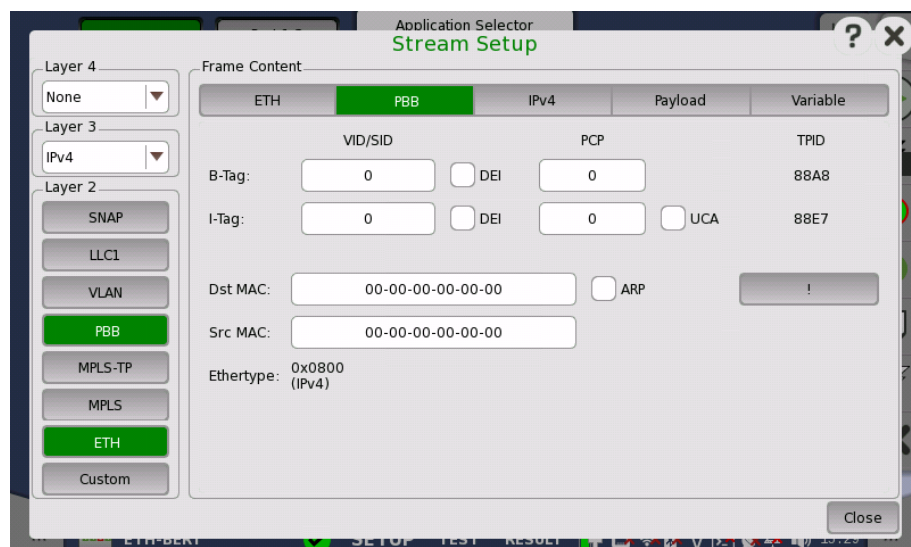
**B-Tag**

Allows you to set a VLAN Identifier (VID), a Drop Eligible Indicator (DEI) and a Priority Code Point (PCP).
Displays a Tag Protocol Identifier (TPID).

I-Tag

Allows you to set a VLAN Identifier (VID), a Drop Eligible Indicator (DEI), a Priority Code Point (PCP) and a User Customer Address (UCA).
Displays a Tag Protocol Identifier (TPID).

Dst MAC

The *MAC-in-MAC destination address* can either be specified manually, or be decided based on an ARP/NDP lookup.

When Layer 3 is set to IPv4, select the **ARP** check box to enable the ARP.

When Layer 3 is set to IPv6, select the **NDP(NS/NA)** check box to enable the NDP.

The ! button is an *instant* button which when touched will perform an ARP or NDP lookup immediately, instead of waiting until the transmitter starts.

Src MAC

Allows you to specify the *MAC-in-MAC source address*.

Ethertype

Shows the type automatically depending on layer configuration. If the value is selectable, select the value by touching the field.

VLAN

Touching the **VLAN** layer button displays the parameters available for the *Virtual LAN* protocol layer.

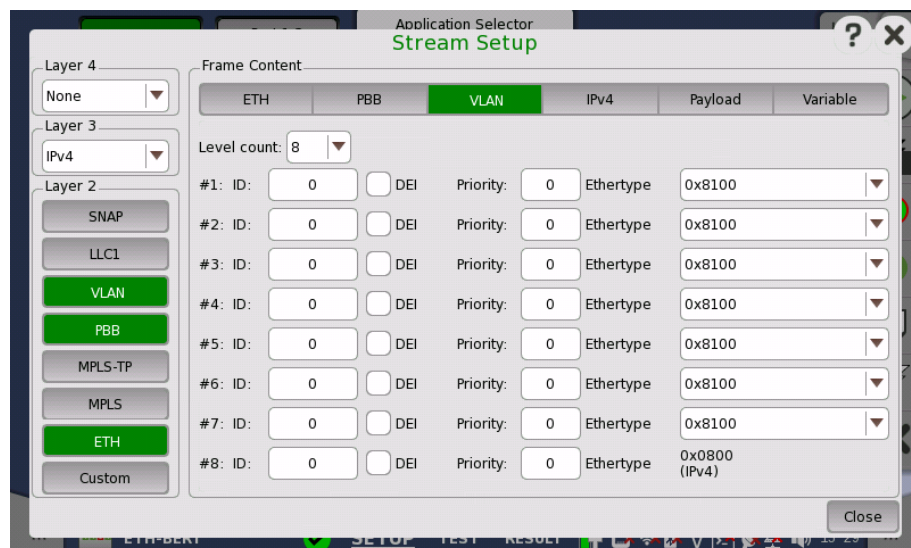

Virtual LAN (VLAN) is used to create independent logical networks within a physical network. When enabled, it adds a 16 bit IEEE 802.1Q field and a 16 bit EtherType field to the header. The 802.1Q is separated into 3 parts.



VLAN affects the Ping and RFC2544/Router Latency test, i.e. when VLAN is enabled, only frames with VLAN tag will be accepted. Furthermore, Ping replies will only be sent if the Ping request contains the same VLAN ID as the one selected.

Level count

Up to eight levels of VLAN can be inserted in the frame. The number of VLAN fields is selected through the **Level count** drop-down menu, and each level is set up individually.



For Ping application, the VLAN level count is supported up to 2. When the VLAN level count is 2, the two VLAN levels will be designated S-VLAN and C-VLAN. S-VLAN is short for Service provider VLAN and C-VLAN is short for Customer VLAN.

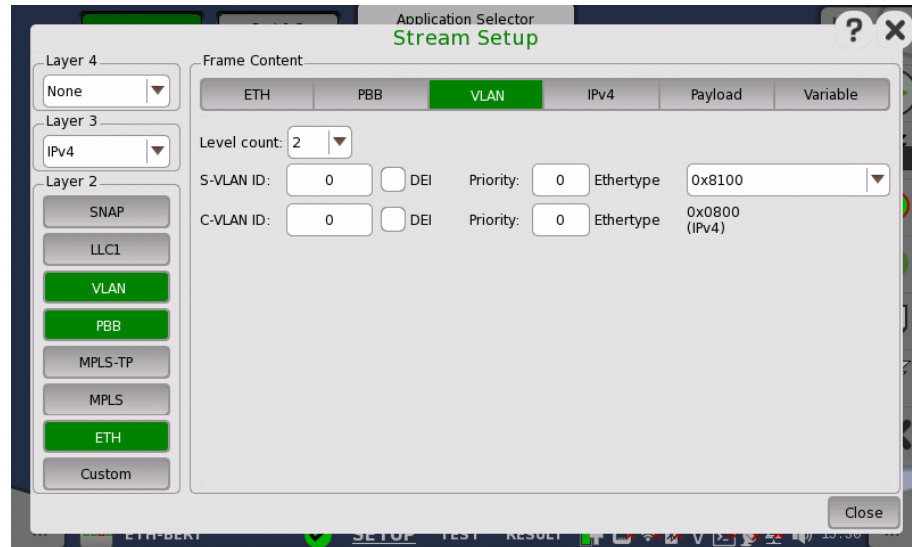

ID

Touching the **ID** (VLAN ID) button launches a setup dialog box from which it is possible to set up a denoting of the virtual LAN.

DEI

Selecting the **DEI** check box sets a 1-bit flag denoting whether MAC addresses inside the frame are in canonical format.

Priority

It is possible to set up the priority level of each frame.

Ethertype

When the Level count is more than one, select the type from **0x8100**, **0x88A8**, **0x9100** or **0x9200**.

When **IPv4** or **IPv6** is set to Layer 3, the Ethertype of the highest level is automatically defined, based on the next protocol element. When **None** is set to Layer 3, it can be set between 0x05DD to 0xFFFF.

LLC1

Touching the **LLC1** layer button displays the parameters available for the *Logical Link Control* protocol layer.



The **DSAP**, **SSAP** and **Control** fields are set automatically, based on the upper protocol layer.

- **DSAP**: Destination Service Access Point value (8 bits)
- **SSAP**: Source Service Access Point value (8 bits)
- **Control**: Control field value (8 bits or 16 bits)

SNAP

Touching the **SNAP** layer button displays the parameters available for the *Sub Network Access Protocol* protocol layer.

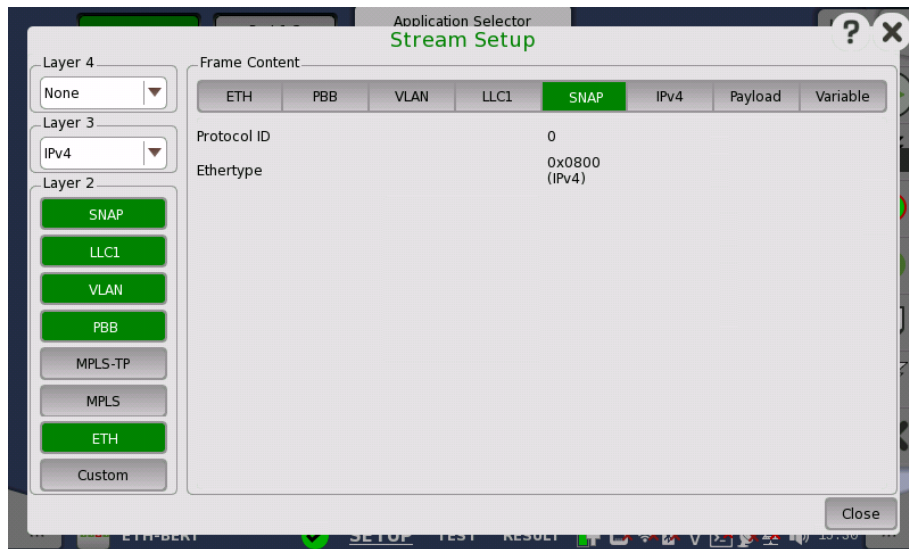

The **Protocol ID** is fixed to **0**, and the **Ethertype** field depends on the upper protocol layer.



'SNAP' is not possible without 'LLC1'!

IPv4

Touching the **IPv4** layer button displays the parameters available for the *Internet Protocol version 4* layer.

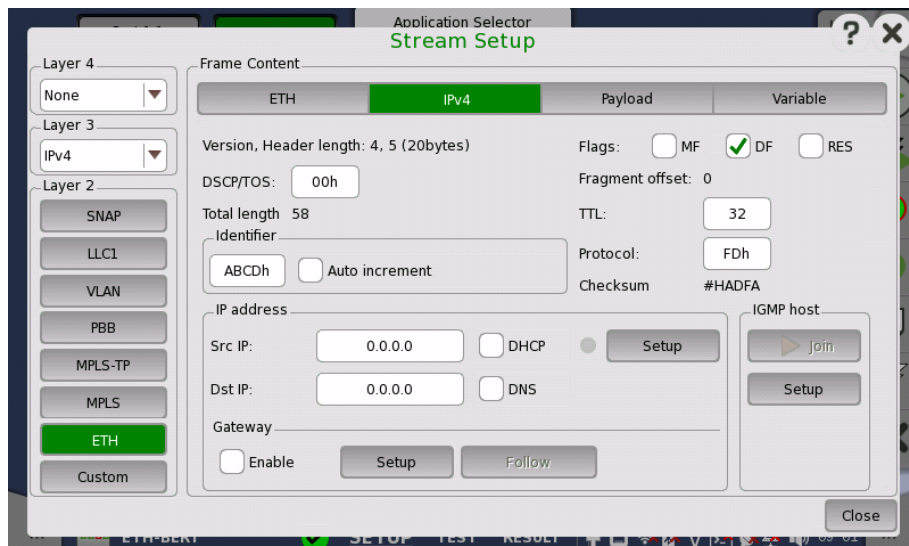

IPv4 header is defined in RFC 791 as below.

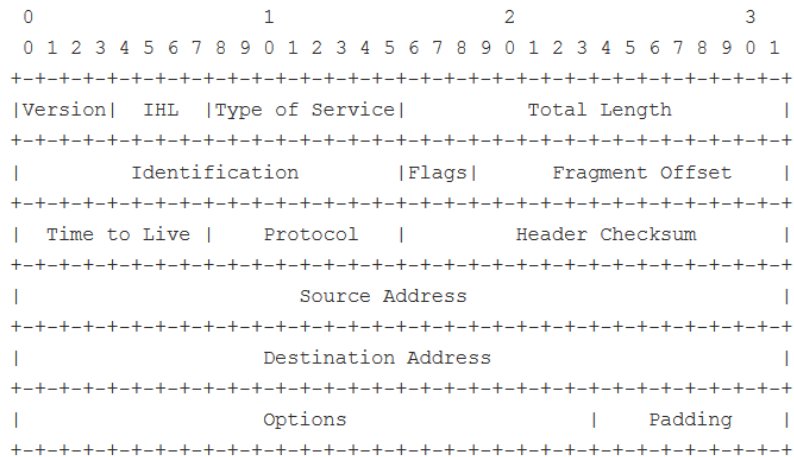

Version, Header length

Shows Version and Header length in the IPv4 header.

DSCP/TOS

When changing the **DSCP/TOS** (Differentiated Service Code Point/Type of Service) setting, it is possible to define some handling characteristics of the datagram, originally defined in RFC 791. Other uses of the **DSCP/TOS** setting are VoIP, DiffServ and ECN.

Total length

Shows Total length in the IPv4 header.

Identifier

The *Identifier* is mainly used for uniquely identifying fragments of an IP datagram. When the **Auto increment** check box is selected, the Identifier will be different for each sent frame.

Flags

Selecting a check box sets its flag bit to "1".

- If the **MF** (More Fragments) flag is set: When a packet is fragmented, all fragments have the MF flag set except the last fragment.
- If the **DF** (Don't Fragment) flag is set: When fragmentation is required to route the packet, then the packet will be dropped.
- **RES** (Reserved) must be zero (i.e. not set).

Fragment offset

Shows Fragment Offset value in the IPv4 header.

TTL

TTL (Time To Live) defines the number of 'hops' a datagram can do before it no longer is forwarded.

Protocol

The **Protocol** field defines the upper/next layer protocol encapsulated in the IP datagram. Typical values in hex are: *1 = ICMP, 6 = TCP* etc.

Checksum

Shows a checksum.

IP address

Src IP and Dst IP can be entered using the format: *255.255.255.255*.



When Multistream traffic is sent from one port to another, make sure that the source address on one port is the same as the destination address on the other port for each of the active streams. This applies both if the two ports are in one instrument and if they are in two different instruments.

The following addresses cannot be used for RFC 6349 application tests.

- All numbers are zero. (i.e, 0.0.0.0)
- Multicast address

Selecting the **DHCP** check box located next to the **Src IP** field will enable the Dynamic Host Configuration Protocol function.

Selecting the **DNS** check box located next to the **Dst IP** field changes the field name to **Hostname**, allowing you to specify the domain name server.

Touching the **Setup** button next to the virtual Lamp in the **Src IP** line will open the **DHCP/DNS Setup** dialog box.

- Selecting the **Renew lease when link is reestablished** check box enables the function that automatically renews the lease when the link is reestablished.
- Selecting the **Get gateway servers through DHCP** check box enables the function that automatically assigns the gateway.
- Selecting the **Get DNS setup through DHCP** check box enables the function that automatically assigns the DNS server.
- **Primary DNS** and **Secondary DNS** allow you to define these IPv4 addresses for the specific stream.
- When allocating IP addresses using DHCP, it is 'leased' for a certain period of time defined by the network. The time when the lease expires is indicated as *Current lease expire time*.
- Touching the **Renew now** button will renew the allocation of the IP address.
- Touching the **Close** button closes the dialog box.

Gateway

Select the **Enable** check box to enable the use of a gateway. When gateway is enabled and the gateway/source address mask falls outside the network mask, an ARP lookup for the gateway IP address will be made. The resulting MAC address is used as destination. Gateway is usually used with ARP enabled as well.

Touching **Setup** next to the **Enable** check box will open the **Gateway Setup** dialog box.

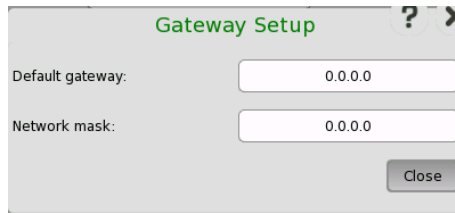

- **Default gateway:** Set the IP address for the default gateway.
- **Network mask:** Set bits, which are used for network mask, to "1" consecutively from the first bit.

Example

Default gateway 128.15.0.1

Network mask 255.255.0.0

In this example, the first eight bits (portion of 128.15) will be a network address.

When the [Follow](#) button is green on the Stream screen, the **Follow** button for Gateway is available. If you select the **Enable** check box when the **Follow** button is in green, **Follow** will be canceled. To set **Follow** again, close the Stream Setup dialog box and turn the **Follow** button in green.

IGMP host

IGMP host is displayed in the following applications.

IGMP stands for Internet Group Management Protocol.

- BERT
- Mon./Gen.

1. Touch **Setup** to set the group address, and **Join** becomes available.
2. Touch **Join** to send a Join message to the IGMP host.

The button name changes to **Leave**.

In this state, the Network Master receives packets whose source address matches the group address. The **Src IP** address in the Stream Setup screen is not used in receiving packets.

Also, the IP address display is followed by **(multicast host)**.

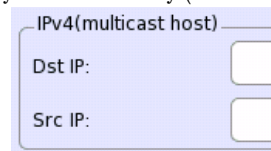

3. Touch **Leave** to send a Leave message to the IGMP host.

Touching **Setup** for IGMP host will open the **IGMP host setup** dialog box.

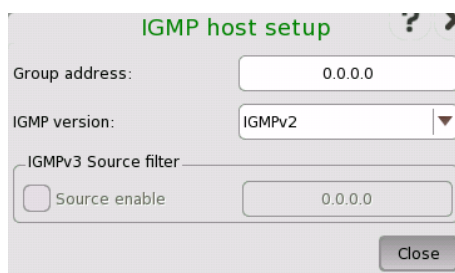

Touch the **Group address** box to set the multicast address of the group. (224.0.0.0 to 239.255.255.255)

Select a version from the **IGMP version** list. The supported functions vary depending on the protocol version.

Option	Function				
	Join	Leave	General Query	Group specific query response	Source filter
IGMPv1	✓	-	✓	-	-
IGMPv2	✓	✓	✓	✓	-
IGMPv3	✓	✓	✓	✓	*

✓: Supported, -: Not supported,

*: The Network Master does not support the function.

IGMPv3 source filter

Selecting the **Source enable** check box enables the Source filter function. Set the IP address for the IGMP frame source.

IPv6

Touching the **IPv6** layer button displays the parameters available for the *Internet Protocol version 6* layer.

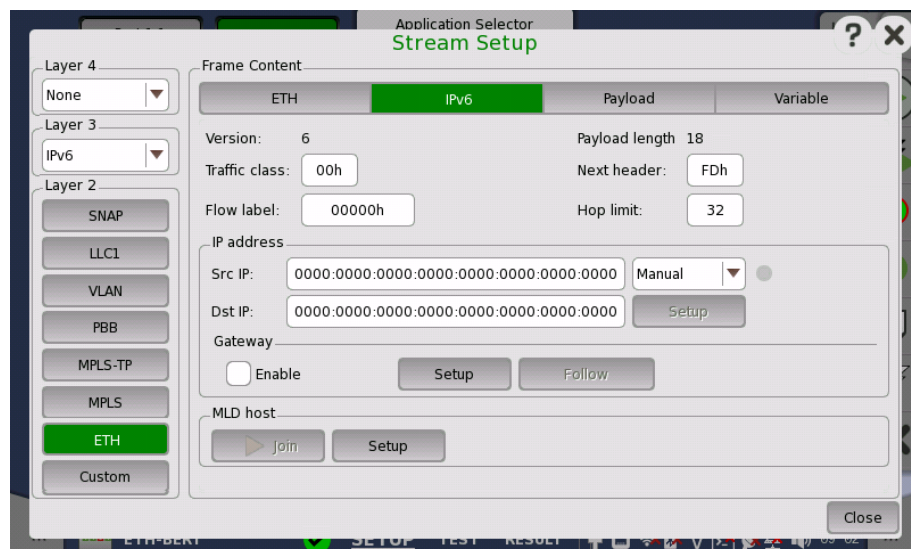

IPv6 header is defined in RFC 2460 as below.

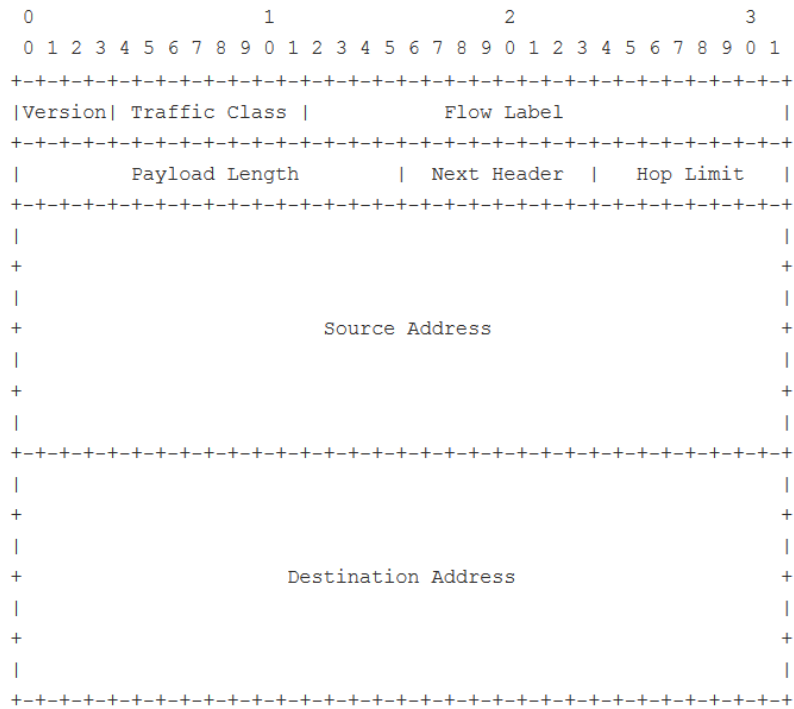

Version

Shows Version in the IPv6 header.

Traffic class

Traffic class is similar to IPv4's **DSCP/TOS** and is used for the class and priority. This is defined in RFC 2474.

Flow label

The *Flow label* indicates that the datagram belongs to a specific sequence of traffic between a source and destination. The default value is **0**.

Payload length

Shows Payload length in the IPv6 header. This value is calculated automatically.

Next header

The *next header* indicates the upper/next layer protocol encapsulated in the IP datagram. Typical values in hex are: *1 = ICMP, 6 = TCP* etc.

Hop limit

The *hop limit* defines the number of 'hops' a datagram can do before it no longer is forwarded.

IP address

Src IP

Select setting mode using drop-down menu.

- **Manual:** touch the field to enter 32 Hex values.
- **Stateless:** configures the address automatically. The lamp lit in green if the automatic configuration has succeeded.
This option is available when PBB nor MPLS-TP is not set to Layer 2.

Touching the **Setup** button next to the virtual Lamp in the **Src IP** line will open the **Stateless IPv6 Setup** dialog box.

Selecting the **Use src MAC** check box configures the interface ID from the MAC address.

When the check box is clear, touch the field to set the interface ID.

Touching **Renew now** starts the source IP address configuration.



*The measurement via routers by using a router advertising message is available for RFC 6349 application test. In that case, select **Stateless**.*

Dst IP

Touch the field to enter 32 Hex values.



The following addresses cannot be used for RFC 6349 application tests.

- All numbers are zero. (i.e., ::)
- Multicast address

For link local addresses (First 16 bits of prefix is FE80), RFC 6349 application tests can be performed if the following requirements are met:

Requirement 1: Both Dst IP address and Src IP address are link local addresses.

Requirement 2: Src IP address satisfies the followings.

- Prefix: FE80:0000:0000:0000
- Interface ID: Modified EUI-64 format generated from Src. MAC

Gateway

Select the **Enable** check box to enable the use of a gateway. Packets whose destination IP address is not found in the network are forwarded to the default gateway address.

Touching **Setup** next to the **Enable** check box will open the **Gateway Setup** dialog box.

- **Default gateway:** Set the IP address for the default gateway.
- **Prefix mask:** Set bits, which are used for the prefix mask, to "1" consecutively from the first bit.

Example

Default gateway 2001:0DBB:0000:0056:0000:1234:5678:9ABC
 Prefix mask FFFF:FFFF:FFFF:FFFF:0000:0000:0000:0000
 In this example, the prefix is 2001:0DBB:0000:0056/64.

When the [Follow](#) button is green on the Stream screen, the **Follow** button for Gateway is available. If you select the **Enable** check box when the **Follow** button is in green, **Follow** will be canceled. To set **Follow** again, close the Stream Setup dialog box and turn the **Follow** button in green.

MLD host

MLD host is displayed in the following applications.

MLD stands for Multi Listener Discovery.

- BERT
- Mon./Gen.

1. Touch **Setup** to set the group address, and **Join** becomes available.
2. Touch **Join** to send a Join message from the Network Master to the MLD host. The button name changes to **Leave**.

In this state, the Network Master receives packets whose source address matches the group address. The **Src IP** address in the Stream Setup screen is not used in receiving packets.

Also, the IP address display is followed by **(multicast host)**.

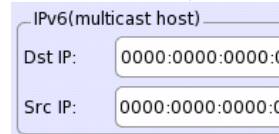

3. Touch **Leave** to send a Leave message to the MLD host.

Touching **Setup** for MLD Host will open the **MLD host setup** dialog box.

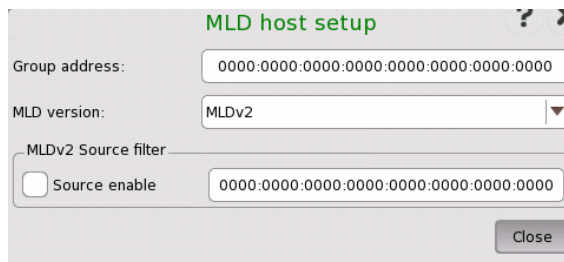

Touch the **Group address** box to set the multicast address of the group. (All the first eight bits are "1".)

Select a version from the **MLD version** list. The supported functions vary depending on the protocol version.

Option	Function				
	Join	Leave	General Query	Group specific query response	Source filter
MLDv1	✓	✓	✓	✓	-
MLDv2	✓	✓	✓	✓	*

✓: Supported, -: Not supported,

*: The Network Master does not support the function.

MLDv2 Source filter

Selecting the **Source enable** check box enables the Source Filter function. Set the IP address for the MLD frame source.

UDP

Touching the **UDP** layer button displays the parameters available for the *User Datagram Protocol* layer.

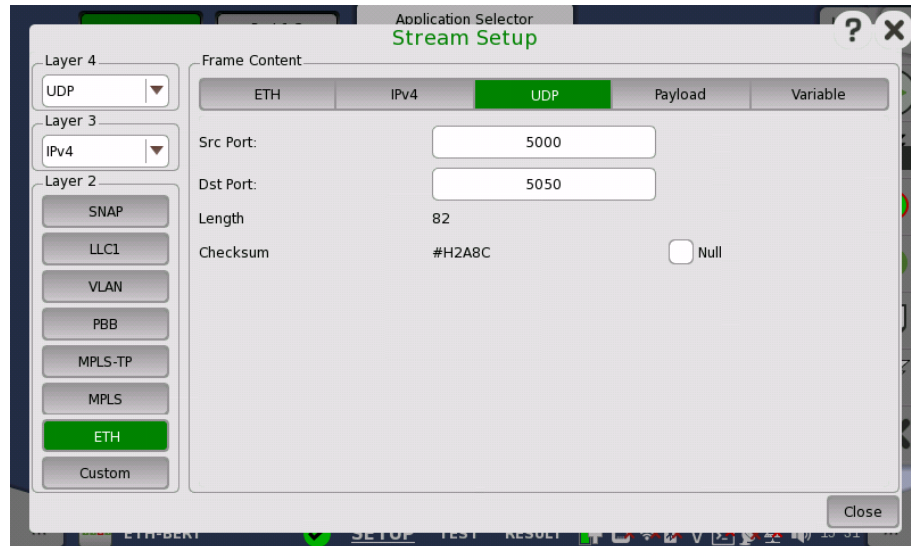

User Datagram Protocol is a core protocol of the Internet protocol suite. The UDP provides a minimal and simple interface between a network layer below and a session layer or application above. This protocol does not guarantee reliable and in-order delivery from sender to receiver.

UDP header is defined in RFC 768 as below.

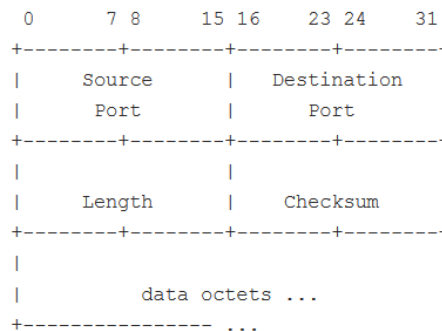

Src Port

Source port identifies the sending port and should be assumed to be the port to reply to if needed. If not used, then it should be zero.

Dst Port

Destination port identifies the destination port and the setting is required.

Length

Shows the packet length in bytes.

Checksum

Optionally, the Checksum may be forced to zero, by selecting the **Null** check box.

TCP

Touching the TCP layer button displays the parameters available for the *Transmission Control Protocol* layer.

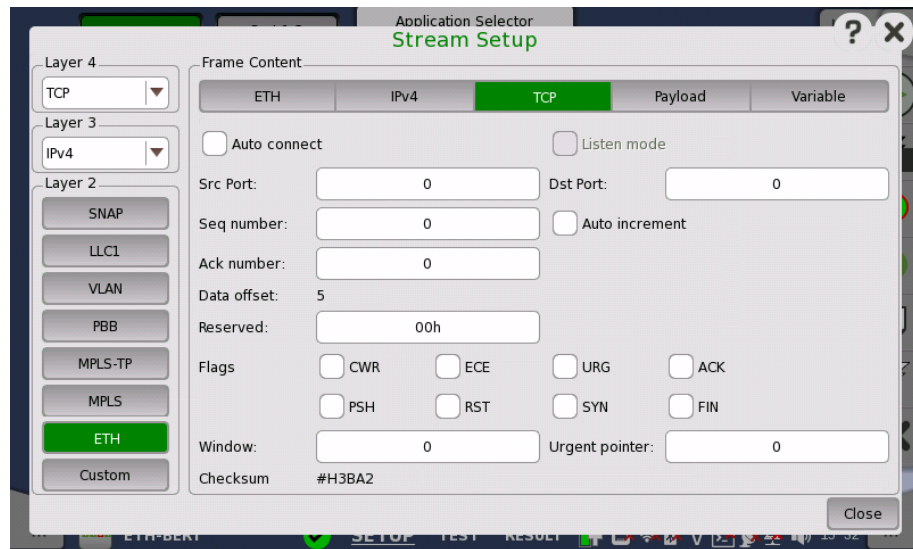

Transmission Control Protocol is a core protocol of the Internet protocol suite. It is the intermediate layer between the Internet Protocol below it and the application above it. This protocol guarantees reliable and in-order delivery from sender to receiver.

The Network Master supports sending frames that resemble TCP frames, but the traffic transmitted will not constitute a real TCP stream, as no handshake is performed.

TCP header is defined in RFC 793 as below.

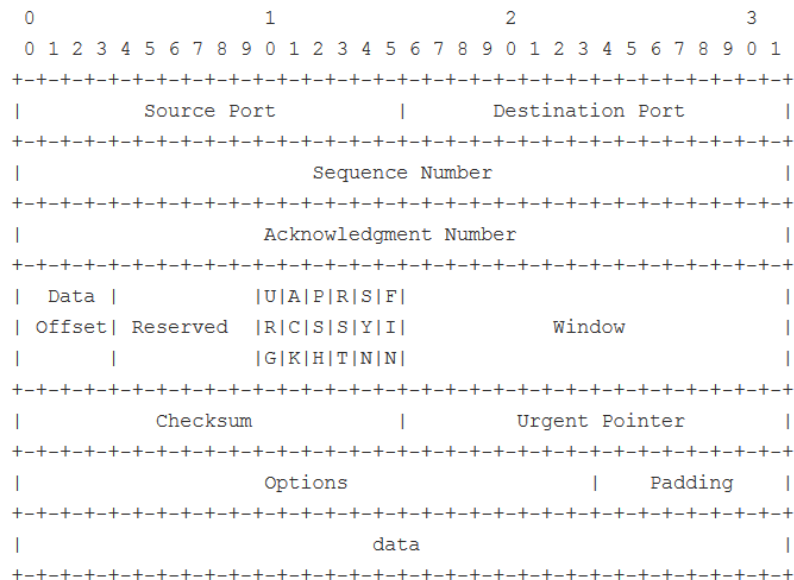

Auto connect

By enabling *Automatic TCP connect*, it is possible to force the transmitter to establish a TCP connection before the actual traffic frames are sent. This makes it possible to pass a firewall/nat router from the inner side.

Listen mode

When *Listen mode* is enabled, the transmitter will await an external TCP connection before the actual traffic frames are sent. This makes it possible to pass a firewall/nat router from the other side (Remark: you must have something establishing the TCP connection from the inner side e.g. Network Master). In this mode the peers MAC, IP, and Port are taken from the incoming TCP connection.

Src Port

Source port identifies the sending port.

Dst Port

Destination port identifies the receiving port.

Seq number

- If the **SYN** flag is present, this is the initial sequence number and the first data byte is the sequence number plus 1.
- If the **SYN** flag is not present, then the first data byte is the sequence number.

The **Auto increment** check box may be selected in order for the Sequence number to follow the number of data bytes sent (Remark: the first data byte will be number zero in this mode, and not the number entered into the **Seq number** field).

Ack number

If the **ACK** flag is set then the value of this field is the sequence number that the sender of the acknowledgment expects next.

Data offset

Data offset specifies the size of the TCP header in 32-bit words. This is set automatically.

Reserved

Reserved for future use and should be set to zero.

Flags

Contains 8 bit flags (control bits). The flags may be programmed individually, however when *Automatic TCP connect* is enabled, most of the flags are controlled by the TCP state engine.

Window

Specifies the size of the *sliding window* (i.e. the maximum receiver buffer). The *window* defines the number of bytes that may be sent before waiting for an acknowledgement from the receiver.

Checksum

The 16-bit checksum field is used for error-checking of the header and data.

Urgent pointer

If the **URG** flag is set then this 16-bit field is an offset from the sequence number indicating the last urgent data byte.

Payload

The *Payload* layer allows you to set the pattern of the Payload of the transmitted frames.

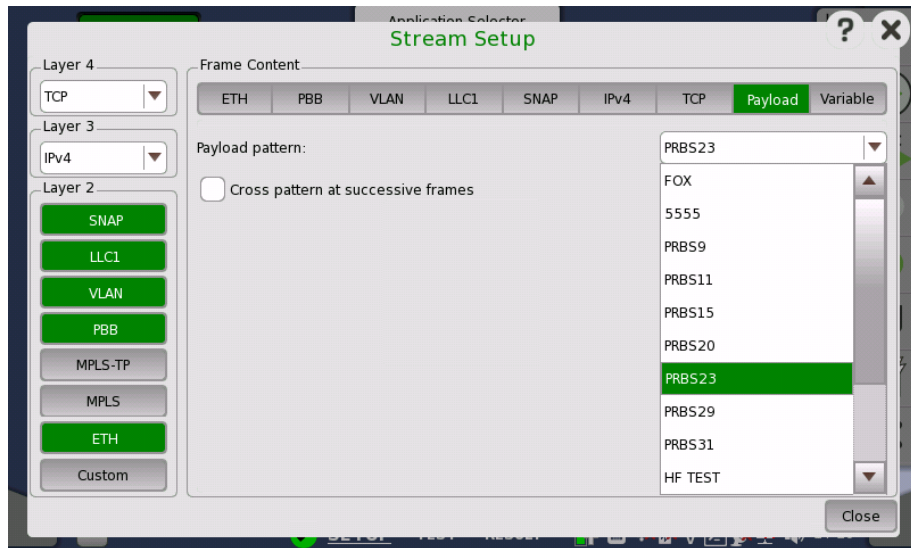

Open the **Pattern** drop-down menu to select the relevant pattern.

- **FOX**: ASCII code bit sequence of "THE QUICK BROWN FOX JUMPS OVER THE LAZY DOG".
- **5555**: Repetition of "0101010101010101".
- **PRBS9** to **PRBS31**: Pseudo-random bit sequence. For PRBS9, its bit length is $511 (=2^9-1)$.
- **HF TEST**: High frequency test pattern. (Defined in IEEE802.3 Annex 48A)
- **CRPAT**: Continuous random test pattern. (Defined in IEEE802.3 Annex 48A)
- **JTPAT**: Jitter tolerance test pattern.
- **SPAT**: Supply noise pattern.
- **User 32 bit**: Repetition of the user defined 32 bits.

If you select the **User 32 bit** pattern, a button appears with which you can open the [Pattern Editor](#) dialog box.

Selecting **Cross pattern at successive frames** sets the payload in Ethernet frames as successive payload pattern through multiple frames.



Cross pattern at successive frames is available for BERT application only.

Following is the explanation of an example when:

- Payload pattern is set to **PRBS15**.
In this case, the pattern length is 32767 bit (≈ 4096 byte).

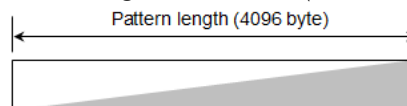

- Frame size is set in Stream on *Test* setup screen so that the payload length will be 1024 byte.

When the check box *is not* selected, Top of 1024 bytes in the payload pattern are set to the payload in Ethernet frames.

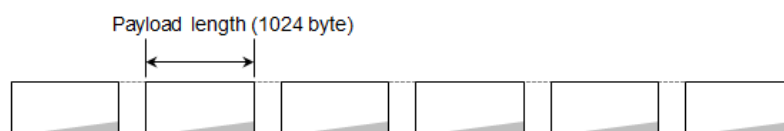

When the check box *is* selected, Payload pattern is divided and set to the payload in Ethernet frames so that the payload pattern is successive through Ethernet frames.

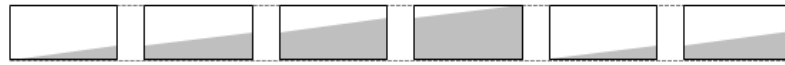

An identifier and time stamp (4 to 13 bytes) for the measurement are put at the head of the payload followed by the pattern specified for **Pattern**.

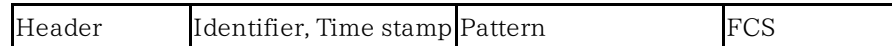

Variable

The *Variable* allows you to set variables in the transmitted frames.

- When **ETH** button in layer 2 is green.

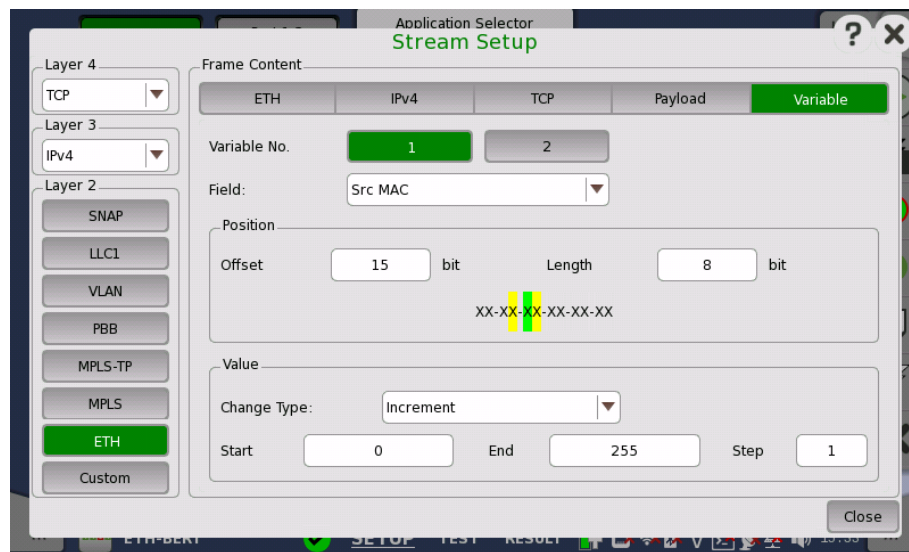

- When **Custom** button in layer 2 is green.

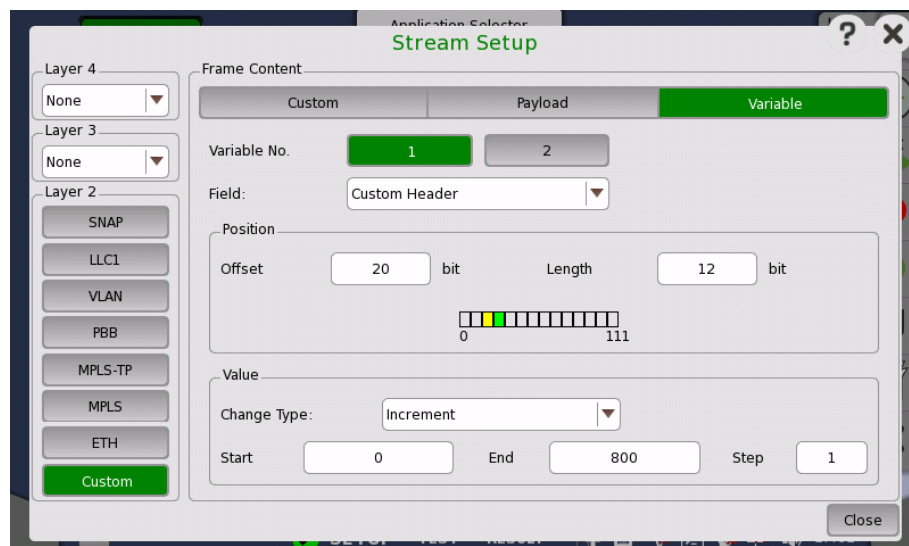

Variable No.

Select which of the two variables you want to define.

Field

Use the drop-down menu to select the type of field. Note that the contents of the drop-down list depends on which protocol layers are currently chosen for the Ethernet frame.

Position

Allows you to specify a bit position and bit length for the variable by **Offset** and **Length** field. The position of a variable is shown in green. 'X' means four bits. When Custom button in Layer 2 is green, row of boxes appears. A box indicates eight bits.

The part in green shows that all bits are variable. The part in yellow shows that partial bits are variable.

Value

Use the **Change Type** drop-down menu to specify how the variable will change: **Increment**, **Decrement** or **Random**.

Specify **Start** and **End** values for the variable, as well as the number of **Steps**.

6.1.2.3 Swap

Touching the **Swap** button in the navigation area displays the following screen. **Swap** button appears in Reflector application.

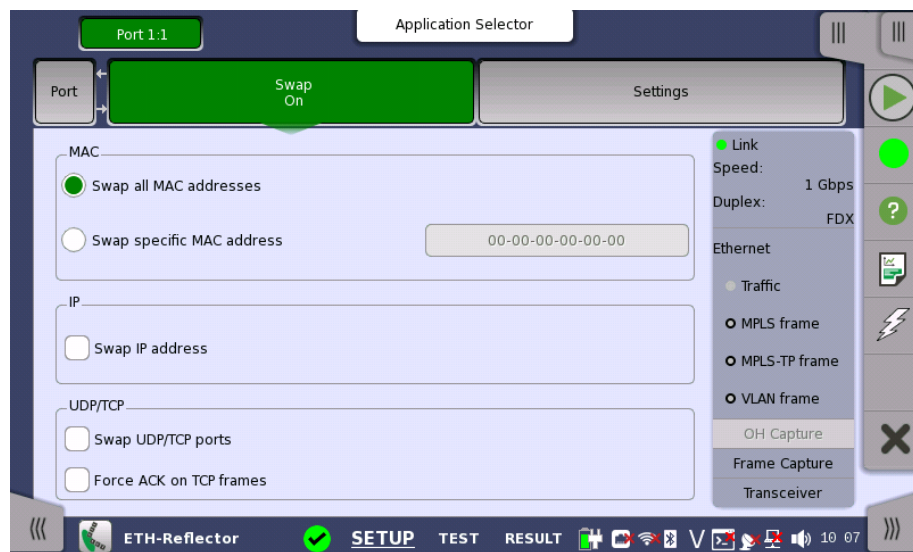

This screen is where you configure the traffic loop by specifying how addresses and/or ports are to be swapped and reflected.

Selecting **Swap all MAC addresses** will transmit/reflect all received frames with their MAC addresses swapped. Use **Swap specific MAC address** to swap and reflect only the frames with a specific MAC address.

The IP addresses and UDP/TCP ports may also be swapped inside the reflected frames. Additionally, the ACK flag may be forced set inside reflected TCP frames.

6.1.2.4 Settings

Touching the **Settings** button in the navigation area will display the screen shown below.

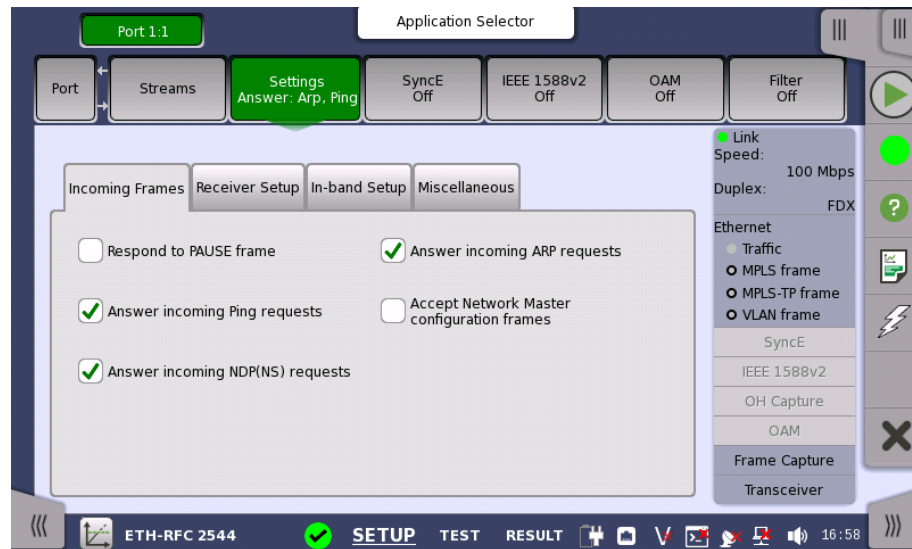

This screen allows you to specify how the Network Master handles incoming frames on the currently selected Ethernet port. It can also be used to inspect the current status of the selected port.

Follows

It is possible to let the Port 2 copy the setup from Port 1 by touching the **Follows** button. This button appears when you can copy the Port 1 settings to Port 2.

The configuration options available in the setup area of the screen are described below. The status information is described in a separate section.

Incoming Frames

Respond to PAUSE frame

Selecting this check box will force the transmitter to pause for a short period of time if a pause frame (defined in IEEE 802.3x) is received, e.g. in case of congestion of the foreign receiver.

Answer incoming Ping requests

When this function is *enabled*, the Network Master will reply to ping requests, using the Source MAC and IP addresses in the replies.

Note that when using the Ping application, this setting is ignored, and replies will always be sent - also from the passive port.

Answer incoming NDP(NS) requests

When this function is *enabled*, the Network Master will reply to incoming NS (Neighbor Solicitation) requests, using the Source MAC and IP addresses in sending out replies.

NDP: Neighbor Discovery Protocol

Note that when using the Ping application, this setting is ignored, and replies will always be sent - also from the passive port.

Answer incoming ARP requests

When this function is *enabled*, Network Master will reply to incoming ARP requests, using the Source MAC and IP addresses in sending out replies.

ARP: Address Resolution Protocol

Note that when using the Ping application, this setting is ignored, and replies will always be sent - also from the passive port.

Accept Network Master configuration frames

This setting appears in the RFC2544 and SAT1564 applications.

When the check box is selected, Network Master can be configured by another Network Master via test interface.

Receiver Setup

Expected preamble length

Allows you to specify the preamble length that the receiver should consider as 'normal' (that is, non-erroneous). The default setting is 8 bytes. The range is from 3 to 15 bytes.

Ignore preamble violations

Select this check box if you want to ignore preamble violations.

IFG lower threshold

Allows you to specify the minimum allowed receiver interframe gap. The default setting is 12 bytes. The range is from 8 to 15 bytes.

Filter IFG violations caused by master/slave clock synchronization

Applies only to Gigabit mode, where the IFG will not be constant, which leads to a larger number of IFG violated frames than expected. Select this function to hide those violations.

Jumbo frame size upper limit

Allows you to specify the size of the Jumbo frames (that is, Ethernet frames longer than 1518 that are not counted as oversized/erroneous). The default setting is 9018 bytes. The range is from 1519 to 16000 bytes.

Enable remote fault

When the check box is selected, the remote fault detection is enabled and Remote fault status is displayed in [Link partner abilities](#) of status information.

In-band Setup

This tab provides the settings for the remote control using commands via the test interface.

In-band control communication supports the following protocols.

- Ethernet/IPv4/TCP
- Ethernet/VLAN/IPv4/TCP

The TCP port number is set in [Remote Control](#) on the Instrument Tool bar.

Allow In-band control

Selecting the check box enables the remote control using commands via test interface.



Only one port is able to allow In-band control. When In-band control is allowed at another port, this setting cannot be made.

*When Port Setup is set to **10Gbps WAN**, In-band control is not performed.*

This tab is not displayed in the Cable, Pass Through, and Discovery applications.

For the Discovery application, In-band control is allowed internally and the remote control via test interface is enabled.

*For the Reflector application, selecting **Allow In-band control** selects the following settings in the [Swap](#) forcibly.*

- Swap IP address
- Swap UDP/TCP ports

Src. MAC

Set a MAC address of the port used for the In-band control communication.

Selecting **Default** uses the MAC address assigned to the port hardware.



When the following MAC addresses are set, Network Masters are not searched in the Discovery application.

- Multicast MAC address (including FF-FF-FF-FF-FF-FF)
- 00-00-00-00-00-00

Src. IP

Set an IP address of the port used for the In-band control communication.

Selecting **DHCP** obtains an IP address automatically. Following setting values are fixed.

- DSCP/TOS: 0x00
- TTL: 20



*Do not set the same address for **Src. IP** of Discovery application one in the application which is searched for.*

The following addresses cannot be set.

- The same IP address as the IP address set at [Ethernet](#) in the Network screen on Instruments tool bar
- Address whose first one byte value is 0 or 224 to 225
- Loopback address (129.0.0.1)
- Network address (all bits in host part are set to '0')
- Broadcast address (all bits in host part are set to '1')

Network mask

Set a network mask for In-band control.



Set a network mask and IP address so that the network does not duplicate with one specified in [Ethernet](#) in Network screen on Instruments tool bar.

Gateway

Selecting check box allows users to set the default gateway IP address.

Password

When the check box is selected, a password with 4 to 8 characters can be set.

VLAN Level

When VLAN is set to the In-band control communication, set **Level** and **ID**.
Following setting values are fixed.

- DEI: OFF
- Priority: 0
- Ethertype: 0x8100 (IPv4)

Miscellaneous

Allow changes to interface setup while a test is running

Select this check box if you want to be able to make changes to the following interface setup during a measurement.

- WAN
- Stream
- Settings
- SyncE
- IEEE 1588v2
- OAM
- Filter

Compatible pattern with CMA3000

Select this check box if you want the PRBS pattern for CMA3000 compatibility. (CMA3000 is the previous model of Network Master Pro.)

Compatible configuration frames with CMA3000 and V2.X or older

This check box appears in SAT (Y.1564) application.

Select this check box if you want the configuration frames to support communication with CMA3000 and Network Master Version 2.X or older.

6.1.2.5 SyncE

Touching the **SyncE** button in the navigation area will display the screen shown below.

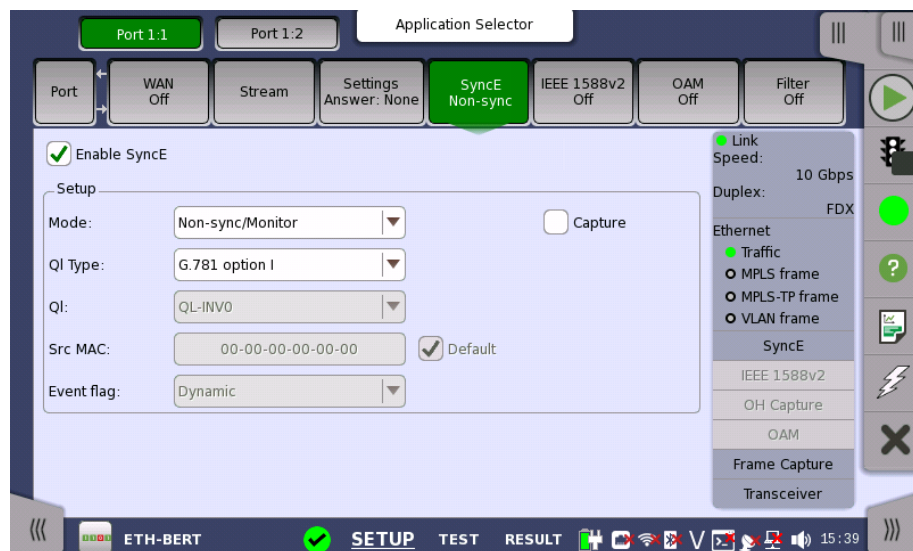

This screen allows you to configure the setup parameters related to Synchronous Ethernet. It can also be used to inspect the current status of the selected port.

The configuration options available in the setup area of the screen are described below. The status information is described in a separate section.

Enable SyncE

The check box is enabled when the interface bit rate is 10 Gbps or less.

Select this check box to enable statistics of the quality level reported in the received ESMC (Ethernet Synchronization Messaging Channel) messages and the generation of Sync Alarm when such messages are missing.



Due to the properties of 10 Mbps Ethernet, the transfer of SyncE timing cannot be guaranteed at this rate.

Follows

It is possible to let the Port 2 copy the setup from Port 1 by touching the **Follow** button. When this button is displayed in green, Port 2 continues to follow Port 1 change. This button appears when the Port 1 settings can be copy to Port 2.

Setup

Mode

- **Non-sync/Monitor:** Does not transmit an ESMC message.
- **Synchronous:** Forces the quality levels specified in *QL* to be transmitted in an ESMC message every second.

QI Type

Allows you to select a protocol/option. This changes the textual representation of the quality levels on the result- and status pages.

QI

Allows you to specify the quality level to be indicated in the transmitted Ethernet signal.

Combination of QI Type and QI

G.781 option I	G.781 option II	G.781 option III	G.8264
QL-INV0	QL-STU	QL-UNK	QL-INV0
QL-INV1	QL-PRS	QL-INV1	QL-INV1
QL-PRC	QL-INV2	QL-INV2	QL-INV2
QL-INV3	QL-INV3	QL-INV3	QL-INV3
QL-SSU-A	QL-TNC	QL-INV4	QL-INV4
QL-INV5	QL-INV5	QL-INV5	QL-INV5
QL-INV6	QL-INV6	QL-INV6	QL-INV6
QL-INV7	QL-ST2	QL-INV7	QL-INV7
QL-SSU-B	QL-INV8	QL-INV8	QL-INV8
QL-INV9	QL-INV9	QL-INV9	QL-INV9
QL-INV10	QL-ST3	QL-INV10	QL-EEC2
QL-SEC	QL-INV11	QL-SEC	QL-EEC1
QL-INV12	QL-SMC	QL-INV12	QL-INV12
QL-INV13	QL-ST3E	QL-INV13	QL-INV13
QL-INV14	QL-PROV	QL-INV14	QL-INV14
QL-DNU	QL-DUS	QL-INV15	QL-INV15

Src MAC

Allows you to specify the MAC address to be used in ESMC messages. You can either use the **Default** check box to force an instrument-specific default value, or touch the address field to enter an address yourself.

Event flag

When Mode is set to **Synchronous**, sets the event flag of packets.

- **Dynamic:** Sets to 1 to the first packet, sets to 0 to other packets.
- **Static Off:** Sets to 0.
- **Static On:** Sets to 1.

Capture

Selecting this check box enables recording of ESMC messages. The captured packet data are saved to file with extension "pcap" when the measurement has ended. The destination folder of the captured data file is the same folder where the measurement result file is saved.



When capturing the packets concerning SyncE protocol, FCS values of Ethernet frames are not included in the captured packet data file.

6.1.2.6 IEEE 1588v2

Touching the **IEEE 1588v2** button in the navigation area will display the screen shown below.

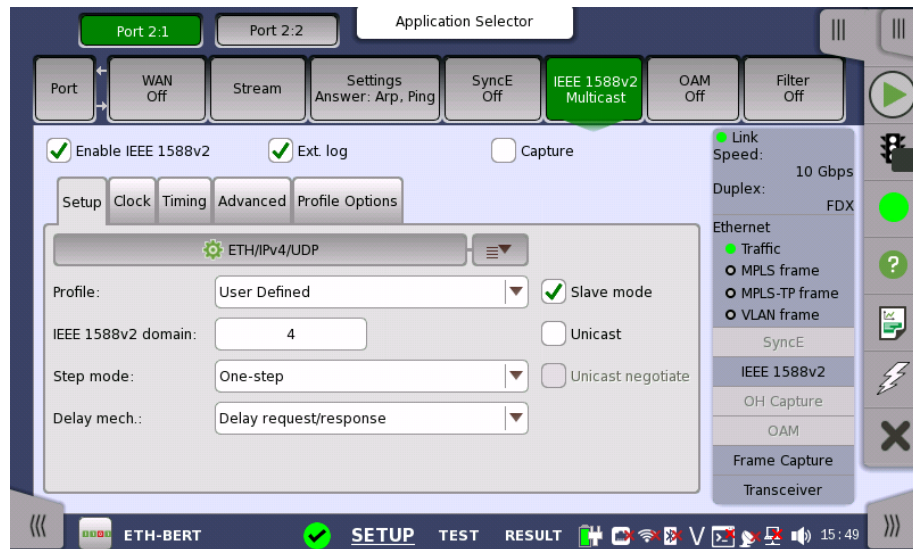

This screen allows you to configure the IEEE 1588 clock (based on the IEEE 1588 Precision Time Protocol (PTP), which is used to distribute absolute time across the Ethernet network). An IEEE 1588 clock can act either as a timing master or as a slave. The screen also contains information about the current status of the selected port.

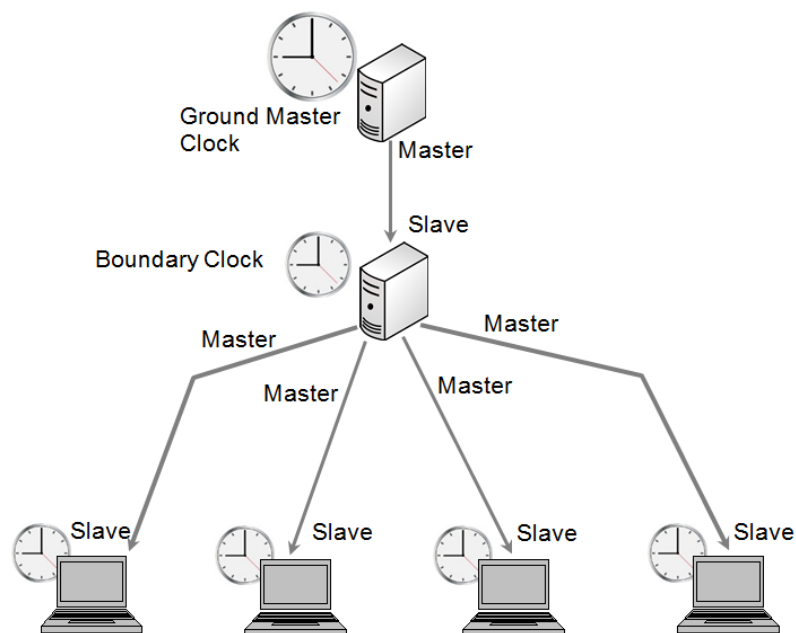

The clock may be set up in either normal or unicast mode.

Enable IEEE 1588v2

The check box is enabled when the interface bit rate is 10 Gbps or less.

Select this check box to start the clock. The settings of the **Slave mode** and **Unicast** check boxes in Setup tab will determine whether the clock runs as a slave or will become the grandmaster clock.



When the Network Master becomes a grandmaster, and if the internal clock is selected (or if the GPS is not available), the IEEE 1588 clock is set from the Network Master's internal time (offset by the selected UTC offset). This action only takes place when the clock is restarted (e.g. disable/enable the clock will force this).

When the Network Master is grandmaster in unicast mode, only one slave will be accepted at a time. Other slaves are just ignored.

Ext. Log

Used to record the external log. If you select this, the **IEEE1588v2 Log** button appears in the navigation area of Test Result.

Capture

Used to capture the packets concerning IEEE 1588 v2 protocol. The captured packet data are saved to file with extension "pcap" when the measurement has ended. The destination folder of the captured data file is the same folder where the measurement result file is saved.



When capturing the packets concerning IEEE 1588v2 protocol, FCS values of Ethernet frames are not included in the captured packet data file.

Follows

It is possible to let the Port 2 copy the setup from Port 1 by touching the **Follow** button. When this button is displayed in green, Port 2 continues to follow Port 1 change. This button appears when the Port 1 settings can be copy to Port 2.

The configuration options available in the setup area of the screen are described below. The status information is described in a separate section.

The setup area of this screen contains the following groupings of parameters, placed on separate tab pages:

- [General setup parameters](#)
- [Master clock specific parameters](#)
- [Timing-specific parameters](#)
- [Advanced parameters](#)
- [Profile option parameters](#)

Setup tab

The **Setup** tab contains the general setup parameters for IEEE 1588v2.

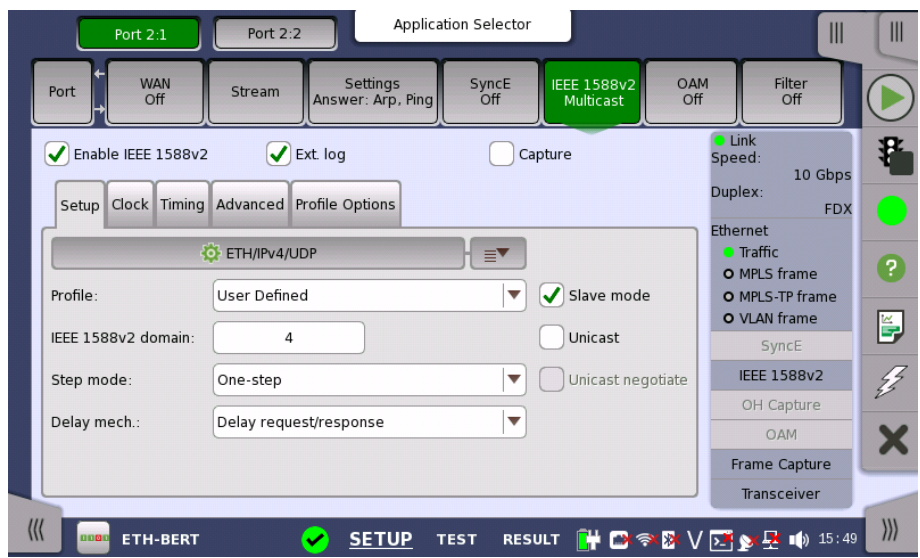

Transport protocol

You can set up the transport protocol(s) for PTP messages either by selecting one of the predefined configurations from the *quick selection menu* (e.g. **ETH/VLAN/IPv4/UDP**) or by configuring the protocols via the *detailed mode* dialog box. Touching the protocol button will launch the *detailed mode* dialog box (the [IEEE 1588v2 Protocol](#) dialog box). Touching the arrow to the right of the button will open the *quick selection menu*.

Depending on the transport protocol setting, Profile setting will be forced to **User Defined**.

Profile

Select the profile of PTP (Precision Time Protocol) from below.

- **User Defined:** Allows you to define the PTP profile. Available IEEE 1588v2 domain is 0 to 255. Unicast/Multicast and the delay mechanism can be set.
- **G.8265.1:** Uses the PTP profile defined in ITU-T G.8265.1. This profile is used for unicast mode. Available IEEE 1588v2 domain is 4 to 23. Transport protocol will be set to **ETH/IPV4/UDP**.
- **G.8275.1:** Uses the PTP profile defined in ITU-T G.8275.1. This profile is used for multicast mode. Available IEEE 1588v2 domain is 24 to 43. Transport protocol will be set to **ETH**.
- **G.8275.2:** Uses the PTP profile defined in ITU-T G.8275.2. In this profile, **Unicast** and **Unicast negotiation** check boxes are both selected. Available IEEE 1588v2 domain is 44 to 63.
- **SMPTE 2059-2:** Uses the PTP profile defined by Society of Motion Picture and Television Engineers (SMPTE). This profile is displayed in the BERT, Mon./Gen., and Sync Test applications.

IEEE 1588v2 domain

Touch the button to set the domain. The PTP messages and data sets are associated with a domain and therefore the PTP protocol is independent for different domains.



In multicast mode, review the attributes in the timing section when changing the domain. Otherwise the best master algorithm may fail for all IEEE 1588v2 clocks in the domain.

Step mode

Allows you to choose between the two step modes: **One-step** and **Two-step**.

- **One-step:** The timestamp of the time when the master send a Sync message is inserted into the Sync message itself. Follow_up message is not sent.
- **Two-step:** The timestamp of the time when the master send a Sync message is inserted into the Follow_up message which follows the Sync message. For Network Master, the same timestamp is inserted into both the Sync message and the Follow_up message.

Delay mech.

Allows you to choose which mechanism to use for calculating the mean path delay: **Delay request/response** or **Peer delay**.

Slave mode

Used to specify that the port can only act as a slave clock. Used in both multicast (normal) and unicast mode.

Unicast

Used to enable the unicast profile. For domains 0 to 3 static unicast is enabled. For domains 4 to 23 the Telecom Profile (ITU-T G.8265.1 IEEE 1588 v2 profile for telecommunication) is used.



If Slave mode is checked, the clock will always run as a slave in both normal and unicast mode. If Slave mode is not checked in normal mode, the best master clock algorithm is run and the result of this will determine if the Network Master can become a grandmaster clock. In unicast mode, if the Slave mode is not checked, the Network Master will become a grandmaster clock.

Unicast negotiate

Selecting the check box enables the unicast negotiation. This check box is available when Profile is set to **User Defined** and the **Unicast** is selected.

Clock tab

The **Clock** tab contains the parameters related to the clock-specific setup. Note that it is not enabled if the port is set in Slave Mode.

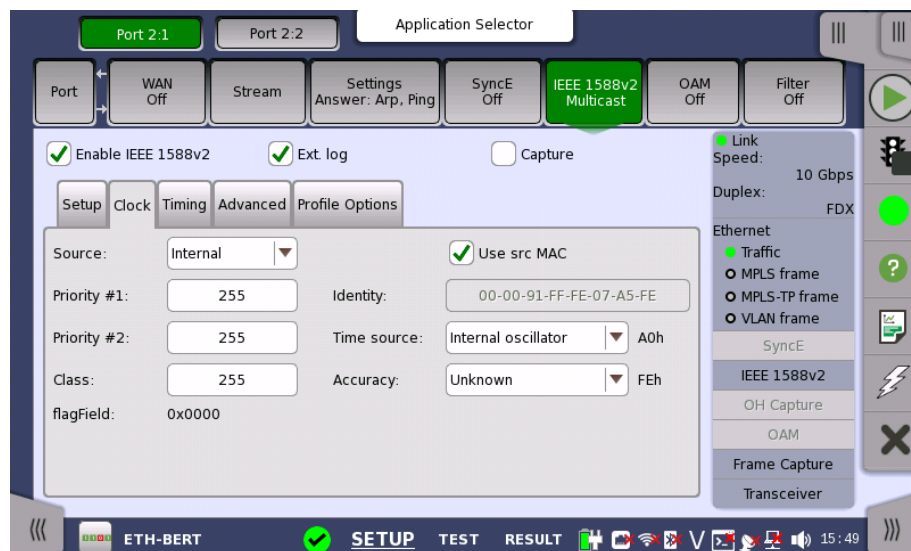

Source

Allows you to specify where the time of the clock should come from.

- **Internal:** Current instrument time
- **GPS:** GPS time (Requires external GPS receiver)

Priority #1/#2

Allows you to specify the priority 1 and priority 2 values. Acceptable values are between 0 and 255.

Class

Allows you to specify the clock class. Acceptable values are between 0 and 255.

Identity

Allows you to specify the 64 bit clock identity. You can either use the Source MAC to generate the identity (by selecting the **Use src MAC** check box) or you can type the identity yourself (using the address field).

Time source

Either choose one of the predefined time sources in the drop-down menu, or select **User defined** and enter a value manually. Acceptable values are between **0x00** and **0xFF**.

Accuracy

Either choose one of the predefined accuracy in the drop-down menu, or select **User defined** and enter a value manually. Acceptable values are between **0x00** and **0xFF**.

ePRTC connected, **PRTC connected**, and **PRTC not connected** are available when:

- Profile is set to **G.8275.1**, **G.8275.2** or **User Defined** and **Slave mode** is cleared.

PRTC: Primary Reference Time Clock

flagField

Displays the flag field of the announce message in hexadecimal. You can edit this value on the [Advanced](#) tab.

Timing tab

The **Timing** tab contains the timing-specific parameters.

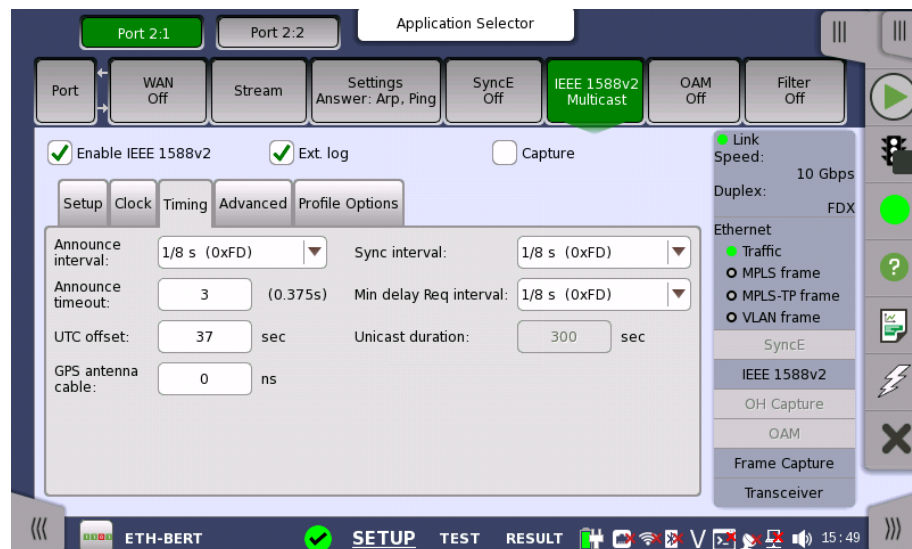

*In multicast mode, it is important that all IEEE 1588v2 clocks in the same domain uses the same announce interval and announce timeout values. Otherwise the best master algorithm may fail. **Sync interval** and **Min. delay Req. interval** should also match the domain.*

Announce interval

Allows you to specify the sending interval of announce messages. Available values are between **1/8 s** and **32 s**.

The data to send actually is displayed in hexadecimal.

Announce timeout

Allows you to specify the number of missed announce intervals before announce timeout. Acceptable values are between **2** and **255**.
The calculated time is displayed right hand of the field.

UTC offset

Set the time difference between the internal clock or Coordinated Universal Time (UTC) and Internal Atomic Time (TAI). For the time of January 2017, set 37 seconds as the difference between UTC and TAI. This value is used when converting the internal time or a GPS based UTC time to TAI based time, which is used in an IEEE 1588 clock. The correct UTC/TAI offset value changes when leap seconds are applied to the UTC time.

GPS antenna cable

Allows you to specify the delay time of GPS antenna cable connected to the Network Master in nano second unit.

When calculating the delay time from the cable length, it is recommendable to use 5 ns/m as the conversion factor.

When using the following GPS provided by Anritsu, set 25 ns.

- G0325A
- MU100090A (When using J1706A GPS antenna of the standard accessory)

Sync interval

Allows you to specify the interval between transmitted sync messages.

Available values are between **1/128 s** and **32 s**.

The data to send actually is displayed in hexadecimal.

Min delay Req. interval

Allows you to specify the minimum interval between transmitted delay request messages. Available values are between **1/128 s** and **32 s**.

The data to send actually is displayed in hexadecimal.

Unicast duration

In unicast slave mode, you ask a master to emit announce, sync and delay response messages for some time. This setting is enabled when the [Setup](#) tab is set to either of the following.

- Profile is set to **G.8265.1** and **Slave mode** is selected.
- Profile is set to **User Defined** and **Slave mode**, **Unicast**, **Unicast negotiate** are selected.

After this period, the master forgets everything about your request. The Unicast duration is this period in seconds. Legal values are from **60** to **1000** seconds. A Network Master unicast slave will renew the request 10 seconds before timeout.

Advanced tab

On the **Advanced** tab, you can edit the flag field of the announce message if the **Slave mode** check box is not selected on the Setup tab.

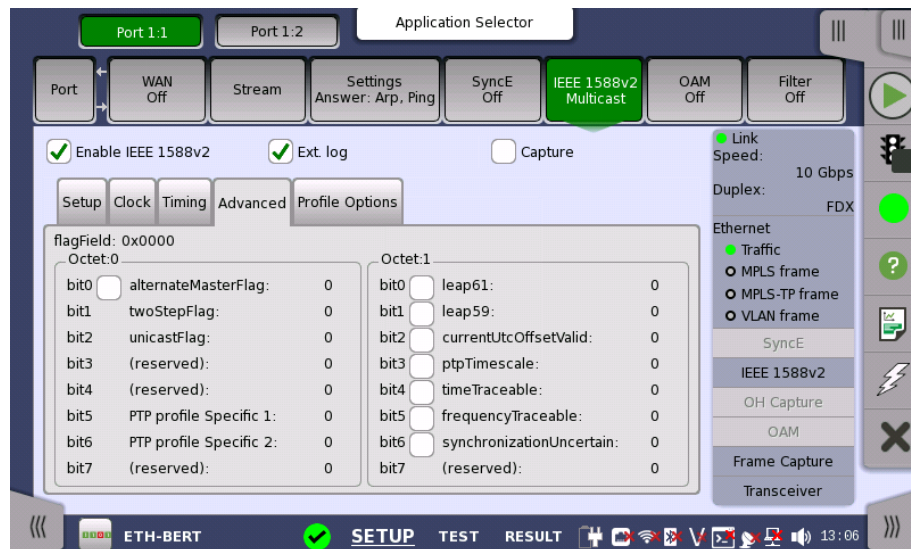

flagField

Displays the bit settings of Octet:0 and Octet:1 in hexadecimal.

Octet:0, Octet:1

Select a checkbox to set the bit to 1.

To change flagField with keeping the time synchronization when **Unicast negotiation** on Setup tab is selected, it is necessary that addresses between the master and the slave have been resolved.

Profile Options tab

The **Profile Option** tab contains the signalling message parameter.

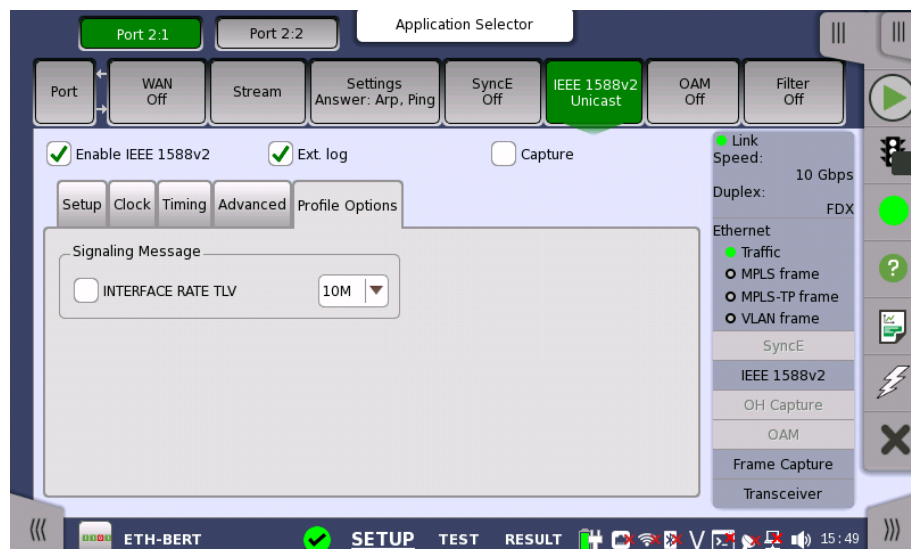

INTERFACE RATE TLV

This checkbox is available only when Profile is set to **G.8275.2** on the Setup tab. Select this check box if bit rates are different between transmitted and received signals. For INTERFACE RATE TLV, refer to the following standards.

- ITU-T G.8271/Y.1366 *Time and phase synchronization aspects of telecommunication networks*

Appendix V . Delay asymmetry resulting from interface rate change in PTP-unaware network elements

- ITU-T G.8275.2/Y.1369.2 *Internet protocol aspects . Transport Precision time protocol telecom profile for phase/time synchronization with partial timing support from the network*
Annex D . TLV for PTP interface rate

When the check box is selected, the Network Master performs the following operation:

- When the Network Master behaves as Master, INTERFACE RATE TLV is appended to Signalling Message.
- When the Network Master behaves as Slave, it calculates delayAsymmetry by using the bitrate of the received INTERFACE RATE TLV.

In the drop-down menu, you can select a desired bit rate.

Transport Protocol

The **IEEE 1588v2 Protocol** dialog box is launched by touching the protocol button on the *Setup* tab page. The dialog box allows you to configure the protocols in *detailed mode*.

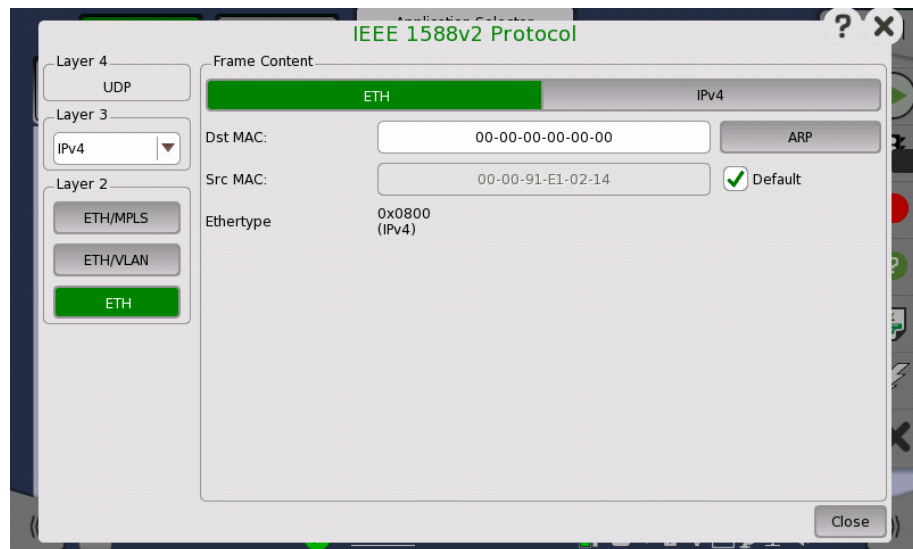

In the **IEEE 1588v2 Protocol** dialog box, the buttons on the left-hand side allow you to select the relevant layers. The current selection is shown at the top of the **Frame Content** area. Touching one of the layer buttons in the **Frame Content** area will display the setup parameters for that layer.

The following layers and parameters are available:

ETH layer

When the Layer 3 is set to **None**, you can set **Src MAC** and **Select Multicast MAC** address only.

- **Dst MAC** - Type in the destination MAC address to be used with all PTP unicast frames.
Touch the **ARP** button to solve any MAC setup in connection with IPv4.
Touch the **NDP (NS/NA)** button to solve any MAC setup in connection with IPv6.
- **Src MAC** - Type in the source MAC address to be used with all PTP frames.
Select **Default** to use the default MAC that comes with the Ethernet port.

- **Ethertype** - Ethernet type is user-selectable only in case of VLAN use.
- **Select Multicast MAC address** - The Multicast MAC address to be used in PTP frames.
 - **Automatic select**: - Multicast MAC address will be set depending on the message.
 - **01-80-C2-00-00-0E**: - Multicast MAC address used for non-peer-delay measurement mechanism messages.
 - **01-1B-19-00-00-00**: - Multicast MAC address used for peer-delay measurement mechanism messages.

MPLS layer

Select the number of levels using **Level count** drop down menu.

- **Level count** Up to eight levels of MPLS fields can be inserted in the frame. The number of MPLS fields is selected through the **Level count** drop-down menu, and each level is set up individually.
- **Label** Allows you to set up a denoting of the MPLS.
- **EXP** Allows you to set up the 3 bit value EXP (Experimental - used in MPLS to support differentiated services (priority)).
- **TTL** Allows you to set up the 8 bit value TTL (Time To Live).

VLAN layer

When the VLAN level count is 2, the two VLAN levels will be designated S-VLAN and C-VLAN. S-VLAN is short for Service provider VLAN and C-VLAN is short for Customer VLAN.

- **Level count** Up to eight levels of VLAN can be inserted in the frame. The number of VLAN fields is selected through the **Level count** drop-down menu, and each level is set up individually.
- **ID** Touching the ID (VLAN ID) button launches a setup dialog box from which it is possible to set up a denoting of the virtual LAN.
- **DEI** Selecting the **DEI** check box sets a 1-bit flag denoting whether MAC addresses inside the frame are in canonical format.
- **Priority** It is possible to set up the priority level of each frame.
- **Ethertype** When the Level count is more than one, select the type from **0x8100**, **0x88A8**, **0x9100** or **0x9200**.
The layer 3 protocol number is displayed in the lowest line.

IPv4 layer

IGMP host and **IGMP version** appear when Profile is set to **SMPTE 2059-1**.

- **Src IP** - Input the IPv4 source address.
- **Dst IP** - In unicast mode, input the IPv4 destination address.
- **DSCP(PTP events message)** and **DSCP(PTP other message)** - Set the DSCP value to be used for transmitted PTP event frames and a value for all other PTP frames. Acceptable values are between 0x00 and 0x3F.
- **IGMP host** - Touch **Join** to send a Join message from the Network Master to the IGMP host. The button display changes to **Leave**.
Touch **Leave** to send a Leave message to the IGMP host.
- **IGMP version** - Select a version from the list. Refer to [IGMP host](#) of Steram setup.

IPv6 layer

MLD host and **MLD version** appear when Profile is set to **SMPTE 2059-1**.

- **Src IP** - Select setting mode using drop-down menu.
 - **Manual**: touch the field to enter 32 Hex values.
 - **Stateless**: configures the address automatically. The lamp lit in green if the automatic configuration has succeeded.

Touching the **Setup** button under the virtual lamp in the **Src IP** line will open the **Stateless IPv6 Setup** dialog box.

Selecting the **Use src MAC** check box configures the interface ID from the MAC address.

When the check box is clear, touch the field to set the interface ID.

Touching **Renew now** starts the source IP address configuration.

- **Dst IP** - In unicast mode type in the IPv6 destination address.
- **Multicast scope** - Select one of the predefined IPv6 multicast scope values or choose **User defined** to manually enter a value. Acceptable values are between 0x0 and 0xF.
- **Payload length** - Select how to set the payload length.
 - Auto**: Payload length in the IPv6 header is set automatically.
 - Null**: Sets 0 to the payload length in the IPv6 header.
- **Extension header** - Appends the IPv6 extension header. Touching **Setup** opens the Extension Header dialog box.

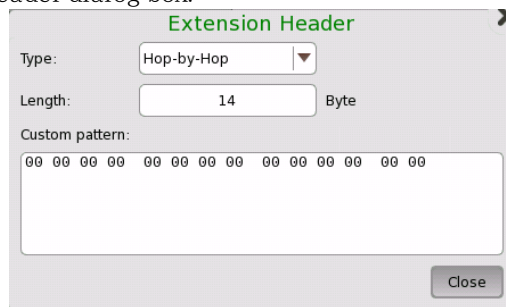

Type

Select the extension header type from **Hop-by-Hop**, **Routing (Type 0)**, **Destination**.

Length

Set the byte length of the custom pattern.

The value setting to the actual header is the truncated value after the decimal point of $(Length + 2)/8$.

Custom pattern

Touch the field to edit the pattern by using [Pattern Editor](#).

- **MLD host** - Touch **Join** to send a Join message from the Network Master to the MLD host. The button name changes to **Leave**.
Touch **Leave** to send a Leave message to the MLD host.
- **MLD version** - Select a version from the list. The function varies by version. Refer to [MLD host](#) of Steram setup.

6.1.2.7 OAM

Touching the **OAM** button in the navigation area will display the screen shown below.

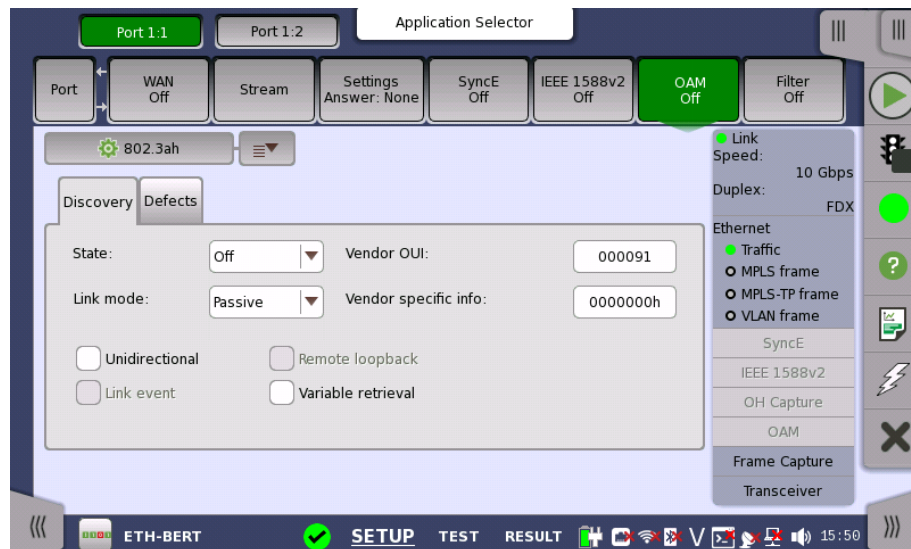

OAM (Operation, Administration and Management) is a group of management functions that provides system or network fault indication, performance monitoring, security management, diagnostic functions, configuration and user provisioning.

This screen allows you to configure the OAM application (i.e. the OAM functions). It can also be used to inspect the current status of the selected port.

Protocol

Touch the button in the top left-hand part of the screen to select the protocol. The setup parameters are grouped according to protocol.

- [802.3ah protocol](#) - Applies to the connectivity of point-to-point connections across one hop.
- [802.1ag protocol](#) - Applies to the connectivity of bridges and paths that pass through bridges. Handles both multipoint connections and point-to-point connections.
- [Y.1731 protocol](#) - An extension to the 802.1ag standard and relies upon the 802.1ag protocol for transport. Applies to both multipoint and point-to-point connections.

In addition, the 802.1ag and Y.1731 protocol screens contain a special [Discovery setup](#).



To change to a different protocol, the state of the current protocol will be set to 'Off'.

Follows

It is possible to let the Port 2 copy the setup from Port 1 by touching the **Follow** button. When this button is displayed in green, Port 2 continues to follow Port 1 change. This button appears when the Port 1 settings can be copy to Port 2.

The configuration options available in the setup area of the screen are described below. The status information is described in a separate section.

OAM Protocol

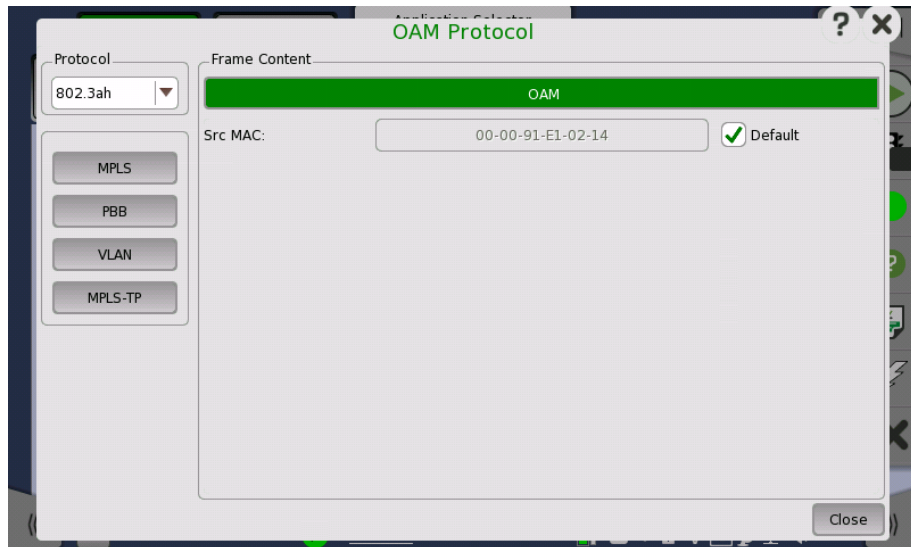

In the **OAM Protocol** dialog box the buttons on the left-hand side allow you to select the relevant layers. The current selection is shown at the top of the **Frame Content** area. Touching one of the layer buttons in the **Frame Content** area will display the setup parameters for that layer.

The following layers and parameters are available:

OAM layer

Src MAC: The MAC address of the source that sends the OAM Protocol Data Units, which is a unicast address. When selecting the **Default** check box, the MAC address which is set to the port is used.

PBB layer

- **B-Tag:** Allows you to set a VLAN Identifier (**VID**), a Drop Eligible Indicator (**DEI**) and a Priority Code Point (**PCP**).
Displays a Tag Protocol Identifier (**TPID**).
- **I-Tag:** Allows you to set a VLAN Identifier (**VID**), a Drop Eligible Indicator (**DEI**), a Priority Code Point (**PCP**) and a User Customer Address (**UCA**).
Displays a Tag Protocol Identifier (**TPID**).
- **Dst MAC:** Touch the field to enter the PBB destination address.
- **Src MAC:** Touch the field to enter the PBB source address.
- **Ethertype:** When the VLAN layer is added, select the type from **0x8100**, **0x88A8**, **0x9100** or **0x9200**.

MPLS, MPLS-TP layer

Select the number of levels using **Level count** drop down menu.

- **Level count** Up to eight levels of MPLS fields can be inserted in the frame. The number of MPLS fields is selected through the **Level count** drop-down menu, and each level is set up individually.
- **Label** Allows you to set up a denoting of the MPLS.
- **Traffic Class** Allows you to set up the 3 bit value EXP (Experimental - used in MPLS to support differentiated services (priority)).
- **TTL** Allows you to set up the 8 bit value TTL (Time To Live).

VLAN layer

When the VLAN level count is 2, the two VLAN levels will be designated S-VLAN and C-VLAN. S-VLAN is short for Service provider VLAN and C-VLAN is short for Customer VLAN.

- **Level count** Up to eight levels of VLAN can be inserted in the frame. The number of VLAN fields is selected through the **Level count** drop-down menu, and each level is set up individually.
- **ID** Touching the **ID** (VLAN ID) button launches a setup dialog box from which it is possible to set up a denoting of the virtual LAN.
- **DEI** Selecting the **DEI** check box sets a 1-bit flag denoting whether MAC addresses inside the frame are in canonical format.
- **Priority** It is possible to set up the priority level of each frame.
- **Ethertype** When the Level count is more than one, select the type from **0x8100**, **0x88A8**, **0x9100** or **0x9200**.
The higher layer protocol number is displayed in the lowest line.

802.3ah protocol setup

Selecting the **802.3ah** protocol will display the screen shown below.

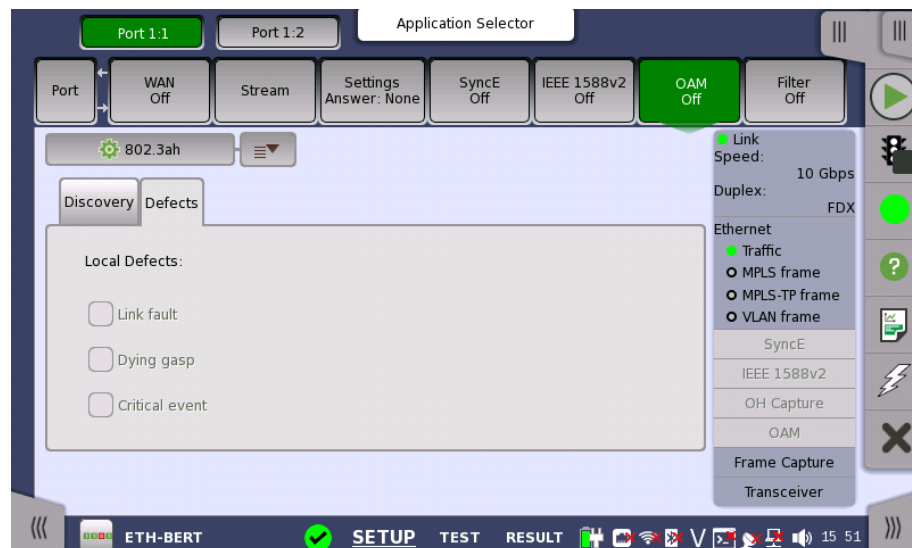

Discovery tab page

The **Discovery** tab page contains the following parameters:

State

Allows you to set the state of the protocol to either **On** or **Off**. Note that when **State** is set to **On**, the *Link mode*, *Vendor OUI* and *Vendor specific info* parameters are disabled.

Link mode

Allows you to set the DTEs to **Active** or **Passive** mode. *Active* DTEs initiate the exchange of information, while *passive* DTEs react to the initiation by the remote DTE. Note that active DTEs operate in a limited respect if the remote OAM entity is in passive mode.

Vendor OUI

Allows you to specify the 24-bit Organizationally Unique Identifier of the vendor. Touch the field to launch an editor dialog box.

Vendor specific info

Allows you to specify a 28-bit identifier that may be used to differentiate a vendor's product models/versions. Touch the field to launch an editor dialog box.

Unidirectional

Select this check box to make the device operate in unidirectional transmission mode.

Link event

This setting is reserved for future use and cannot be set.

Remote loopback

This setting is reserved for future use and cannot be set.

Variable retrieval

Select this check box to make the DTE support sending Variable Response OAMPDUs.

Defects tab page

The Defects tab page allows you to enable/disable local defects.

Link fault

Select this check box to enable a message if the PHY determines that a fault has occurred on the receive direction of the local DTE.

Dying gasp

Select this check box to enable a message if an unrecoverable local failure condition has occurred.

Critical event

Select this check box to enable a message if an unspecified critical event has occurred.

802.1ag protocol setup

Selecting the 802.1ag protocol will display the screen shown below.

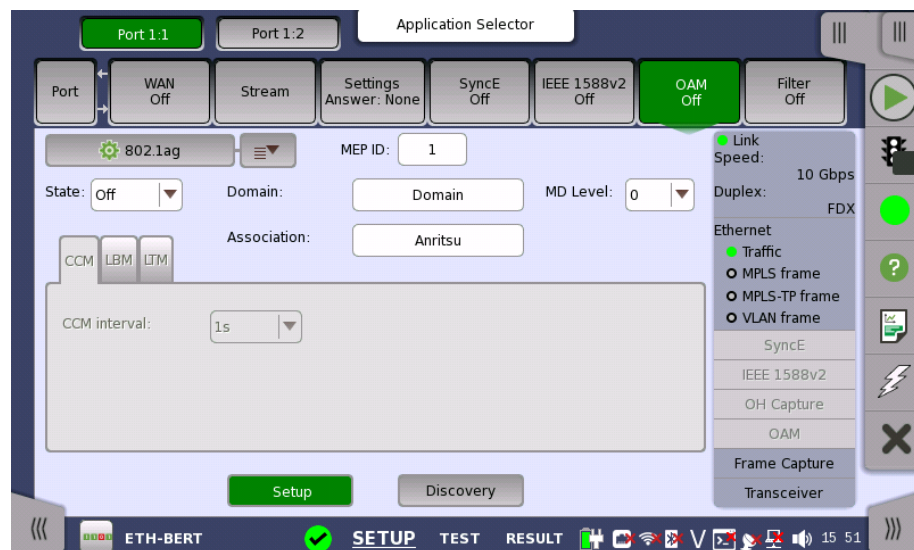

The screen contains two views: the default Setup view and the Discovery view. Use the **Setup** and **Discovery** buttons at the bottom of the screen to switch between the two views.

The Setup view is described below. The Discovery view is described in a separate section.

General parameters

State

Allows you to set the state of the protocol to either **On** or **Off**. Note that when **State** is set to **On**, the other general parameters are disabled, but the tab pages and their contents are enabled.

MEP ID

Allows you to specify the Local Maintenance Point ID, which will identify the unit in the MA.

Domain

Allows you to identify the network or part of the network for which faults in connectivity are managed.

MD Level

Use the drop-down menu to specify the level at which the MEP exists.

Association

Allows you to specify the Main Association Identifier.

CCM tab page

The **CCM** tab page contains the following parameter:

CCM interval

Use the drop-down menu to specify the frequency at which CCMs are transmitted and expected to be received.

LBM tab page

The **LBM** tab page contains the following parameters:

Optional TLV

Use the drop-down menu to select a TLV type, if relevant. The possible types are: **Data TLV** and **Test TLV**. If you select one of the TLV types, fields for specifying the length and value will appear.

Length

Only available if a Data or Test TLV type has been selected. Allows you to specify the length of the TLV.

Value

Only available if a Data or Test TLV type has been selected. Allows you to specify the value of the TLV. Note that for the Data TLV type, this field is an entry field where you open an editor and type the value; for the Test TLV type, it is a drop-down menu.

LTM tab page

The **LTM** tab page contains the following parameters:

TTL

Allows you to specify a TTL value. Used to indicate whether or not an LTM should be terminated by the receiver.

Trans ID

Allows you to specify the transaction number for the LTM.

Y.1731 protocol setup Selecting the **Y.1731** protocol will display the screen shown below.



The screen contains two views: the default **Setup** view and the **Discovery** view. Use the **Setup** and **Discovery** buttons at the bottom of the screen to switch between the two views.

The **Setup** view is described below. The **Discovery** view is described in a separate section.

General parameters

State

Allows you to set the state of the protocol to either **On** or **Off**. Note that when **State** is set to **On**, the other general parameters are disabled, but the tab pages and their contents are enabled.

MEP ID

Allows you to specify the Local Maintenance Point ID, which will identify the unit in the MEG.

MEG ID

Allows you to identify the MEG to which the MEP belongs.

MEG level

Use the drop-down menu to specify the MEG level at which the MEP exists.

CCM tab page

The **CCM** tab page contains the following parameter:

CCM interval

Use the drop-down menu to specify the frequency at which CCMs are transmitted and expected to be received.

LBM tab page

The **LBM** tab page contains the following parameters:

Optional TLV

Use the drop-down menu to select a TLV type, if relevant. The possible types are: **Data TLV** and **Test TLV**. If you select one of the TLV types, fields for specifying the ID will appear.

Length

Only available if a Data or Test TLV type has been selected. Allows you to specify the length of the TLV.

Value

Only available if a Data or Test TLV type has been selected. Allows you to specify the value of the TLV. Note that for the Data TLV type, this field is an entry field where you open an editor and type the value; for the Test TLV type, it is a drop-down menu.

LTM tab page

The **LTM** tab page contains the following parameters:

TTL

Allows you to specify a TTL value. Used to indicate whether or not an LTM should be terminated by the receiver.

Trans ID

Allows you to specify the transaction number for the LTM.

TST tab page

The **TST** tab page contains the following parameters:

Frames to send

Allows you to specify the number of frames to be transmitted.

Rate

Use the drop-down menu to select the rate at which frames are transmitted.

Optional TLV

Use the drop-down menu to select the **Test TLV** type, if relevant. Fields for specifying the length and value will then appear.

Length

Only available if the Test TLV type has been selected. Allows you to specify the length of the TLV.

Value

Only available if the Test TLV type has been selected. Use the drop-down menu to select the value of the TLV.

MCC tab page

The **MCC** tab page contains the following parameters:

OUI

Allows you to specify the Organizationally Unique Identifier for the organization defining a specific format and meaning of ETH-MCC.

Data

Allows you to specify any required additional information. The type of information depends on the specific application of ETH-MCC.

LCK tab page

The **LCK** tab page contains the following parameters:

Client MEG level

Allows you to specify the MEG level of the client MEG.

LCK rate

Use the drop-down list to select the rate of the LCK frames being transmitted.

AIS tab page

The **AIS** tab page contains the following parameters:

Client MEG level

Allows you to specify the MEG level of the client MEG.

AIS rate

Use the drop-down menu to select the rate of the AIS frames being transmitted.

1DM tab page

The **1DM** tab page contains the following parameters:

Type

Use the drop-down menu to select the relevant operation type (**On-demand operation** or **Proactive operation**). The same 1DM frame format can be used for both.

Rate

Use the drop-down menu to select the rate at which 1DM frames are transmitted.

Frames to send

Allows you to specify the number of frames to transmit.

Optional TLV

Use the drop-down menu to select a TLV type, if relevant. The possible types are: **Data TLV** and **Test TLV**. If you select one of the TLV types, fields for specifying the ID will appear.

Length

Only available if a Data TLV type has been selected. Allows you to specify the length of the TLV.

Value

Only available if a Data TLV type has been selected. Allows you to specify the value of the TLV. Note that for the Data TLV type, this field is an entry field where you open an editor and type the value.

ID

Only available if a Test TLV type has been selected. Allows you to specify the value of the ID.

DMM tab page

The **DMM** tab page contains the following parameters:

Type

Use the drop-down menu to select the relevant operation type (**On-demand operation** or **Proactive operation**).

Rate

Use the drop-down menu to select the rate at which DMM frames are transmitted.

Frames to send

Allows you to specify the number of frames to transmit.

Delay threshold

Allows you to specify a delay threshold that is used when a DMM test is active. If the delay meets or exceeds that threshold, the user is alerted.

Optional TLV

Use the drop-down menu to select a TLV type, if relevant. The possible types are: **Data TLV** and **Test TLV**. If you select one of the TLV types, fields for specifying the ID will appear.

Length

Only available if a Data TLV type has been selected. Allows you to specify the length of the TLV.

Value

Only available if a Data TLV type has been selected. Allows you to specify the value of the TLV. Note that for the Data TLV type, this field is an entry field where you open an editor and type the value.

ID

Only available if a Test TLV type has been selected. Allows you to specify the value of the ID.

LMM tab page

The **LMM** tab page contains the following parameters:

Rate

Use the drop-down menu to select the rate at which LMM frames are transmitted.

Frames to send

Allows you to specify the number of frames to transmit.

Loss threshold

Allows you to specify a loss threshold that is used when an LMM test is active. If the loss ratio meets or exceeds that threshold, the user is alerted.

SLM tab page

The **SLM** tab page contains the following parameters:

Rate

Use the drop-down menu to select the rate at which SLM frames are transmitted.

Frames to send

Allows you to specify the number of frames to transmit.

Loss threshold

Allows you to specify a loss threshold that is used when an SLM test is active. If the loss ratio meets or exceeds that threshold, the user is alerted.

EXM tab page

The **EXM** tab page contains the following parameter:

Data

Allows you to specify a string which you can send in a message to other remote maintenance points.

VSM tab page

The **VSM** tab page contains the following parameter:

Data

Allows you to specify a string which you can send in a message to other remote maintenance points.

Discovery view (802.1ag/Y.1731 protocols)

Touching the **Discovery** button available for the 802.1ag or Y.1731 protocol will display the screen shown below.

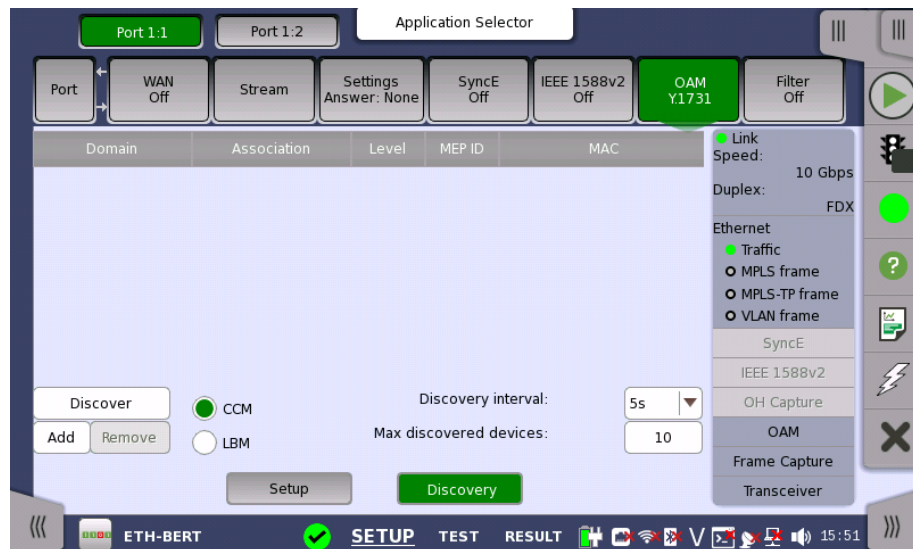

The contents of the Discovery view screen is the same for both protocols. The screen contains the following parameters:

CCM/LBM

Select the radio button for the relevant method of discovery.

- **CCM** - Passive method. Discover Remote Maintenance points by looking at incoming CCM frames. This is the preferred method of discovery and the default selection.
- **LBM** - Active method. Discover other devices by sending out a multicast loopback message and discover the devices' MAC addresses.

Discovery interval

Use the drop-down menu to specify the time period during which to wait and discover messages.

Max discovered devices

Allows you to specify the maximum number of devices that will be discovered.

Discovering devices

To discover devices, touch the **Discover** button on the left side of the screen. This will display the **Discovery** dialog box.

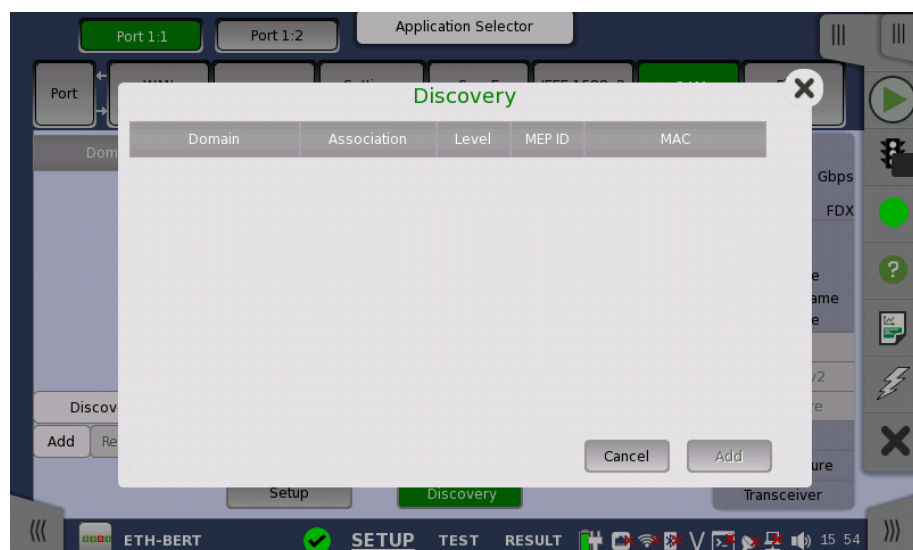

Devices will appear in the dialog's list as they are discovered. Select the device in the list and touch the **Add** button in the dialog box. The device is added to the list displayed on the Discovery view screen.

Adding devices manually

To add devices manually, touch the **Add** button on the left side of the Discovery view screen. This will launch the **Add Rmp** dialog box where you can enter identification data for a specific remote device.

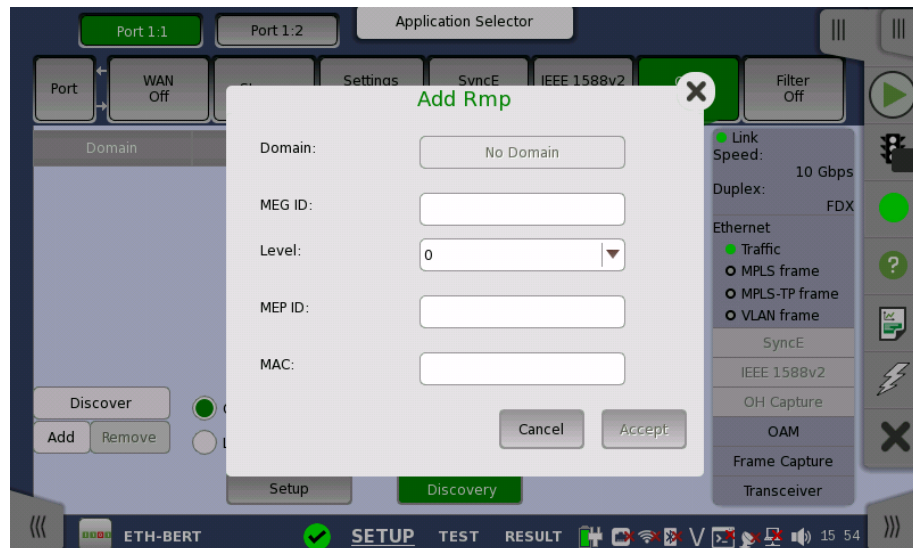

The **Add Rmp** dialog box contains the following parameters:

Domain

Allows you to specify the MD to which the MEP belongs. You can set the domain when 802.1ag is selected.

MEG ID

Allows you to specify the MEG to which the MEP belongs.

Level

Use the drop-down menu to select the MD level at which the MEP exists.

MEP ID

Allows you to specify the Maintenance Point ID that the unit will be known as in the MA. Note that this is the only required parameter.

MAC

Allows you to specify the MAC address of the remote unit.

Accept

Touch the **Accept** button when you have entered the desired data in the dialog box. The identified unit is then added to the list displayed on the Discovery view screen. Note that the **Accept** button is enabled only when you have entered a value in the **MEP ID** field.

Removing devices

To remove a device from the list displayed on the Discovery view screen, select the device and then touch the **Remove** button on the left side of the screen.

6.1.2.8 Filter

Touching the **Filter** button in the navigation area will display the screen shown below.

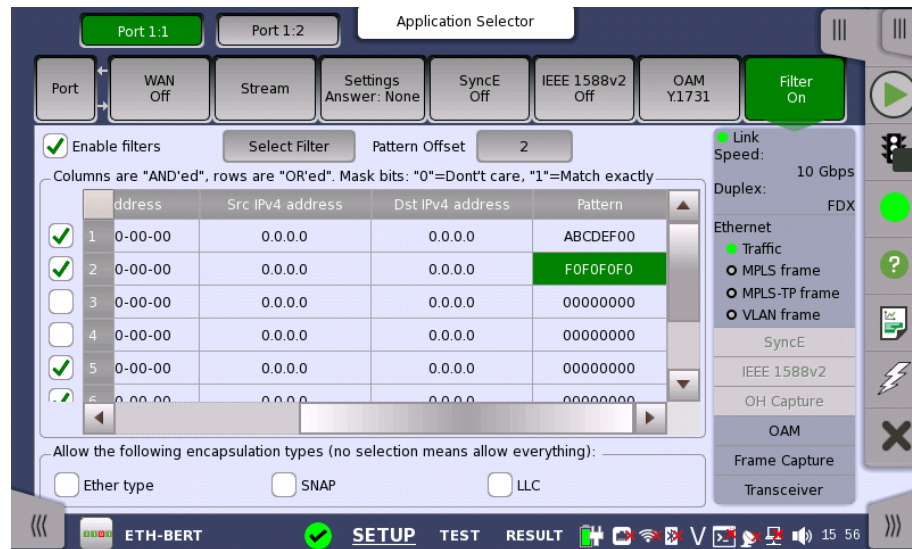

This screen allows you to set up filters and masks for the reception of Ethernet frames. It can also be used to inspect the current status of the selected port.

The configuration options available in the setup area of the screen are described below. The status information is described in a separate section.

Enable filters

Select this check box to be able to set up new filters or make changes to the existing ones.

Select Filter

Opens the [dialog box](#) to set target fields to be filtered.

Pattern Offset

The button will be enabled if **Pattern** is selected in Select Filter dialog box. Set the number of bytes counted from top of destination MAC address byte.

Follows

It is possible to let the Port 2 copy the setup from Port 1 by touching the **Follow** button. When this button is displayed in green, Port 2 continues to follow Port 1 change. This button appears when the Port 1 settings can be copy to Port 2.

The filter and mask table shows the currently existing filters. There are 8 rows, each representing a filter which (when enabled) is applied to each received frame. Each filter is composed as a set of values and/or masks (e.g. MAC destination address, IP addresses etc.). If all values in at least one enabled row/filter matches, the frame will pass.

If the mask for a specific value is enabled, only bits that are "1"/on are compared to the frame. For instance, if MAC Destination value is '00-12-34-56-78-9A' and the mask is set to '00-FF-00-FF-FF-FF', only frames with MAC addresses 'XX-12-XX-56-78-9A' will pass.

Columns are "AND'ed", rows are "OR'ed".

To specify the set of values and/or masks available for each filter (i.e. the columns of the table), touch the **Select Filter** button. This will launch the filter editor dialog box, which contains a number of check boxes for enabling filters and masks on different addresses.

To set up / edit a filter, touch the relevant table cell. This will launch the filter/mask NumPad dialog box.

Allow the following encapsulation types

At the bottom of the screen, it is possible to only allow certain encapsulation types.

- **Ether type:** allows passing of Ethernet frames.
- **SNAP:** allows passing frames which has SNAP header.
- **LLC:** allows passing of frames which has LLC header.

If none are selected, all frames including other than Ethernet frame will pass the filter.

Select Filter

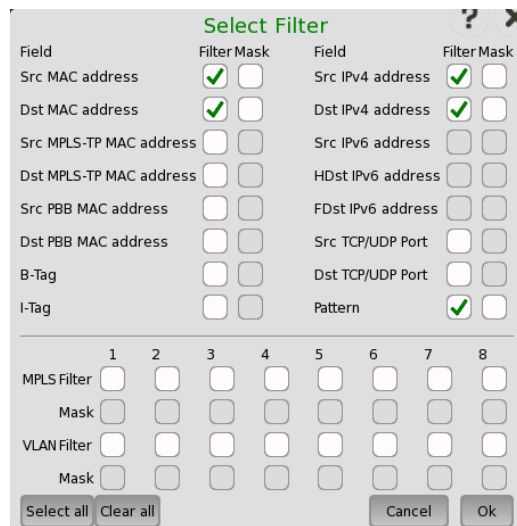

The filter editor dialog box contains a number of check boxes for enabling filters and masks on different addresses. Selectable check boxes depend on frame structure. The selected filters appear in row of the table.

MPLS Filter, VLAN Filter setting

MPLS Filter and VLAN Filter can be selected up to eight levels because these layers may have up to eight levels. The parameters in each filter can be set independently.

For setting parameters, refer to [MPLS](#) or [VLAN](#) in "Stream" subsection.

Pattern filter setting

With the pattern value, it is possible to match a user-defined 32 bit value to a specific offset defined by **Pattern Offset**. The pattern offset applies to all 8 filters but will only affect the enabled ones.

1. Select check box of **Pattern** on the Select Filter dialog box.
2. Touch **Pattern Offset** button.
3. Specify the Pattern Offset. This is the number of bytes counted from top of destination MAC address byte. If you specified "7", the four bytes of source MAC address are set to the object of filtering.

4. Touch the cell of **Pattern** in the table on the setup area.
5. Specify the pattern of four bytes.
6. Select the check box at left-side of the table.

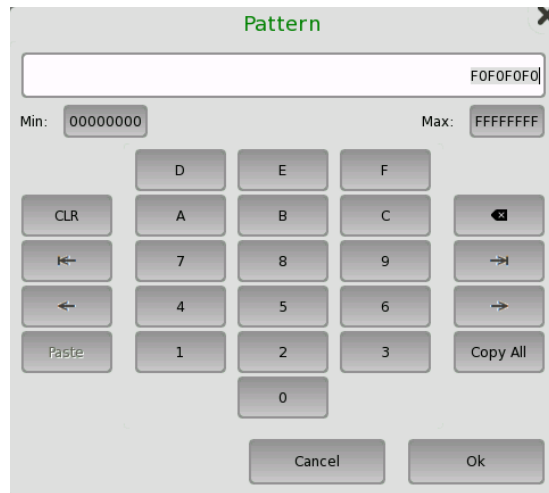

For MPLS/VLAN pattern setting, the dedicated dialog box will launch.

MPLS

Enter the number of MPLS label and TTL (Time To Live). You can select **Bottom of Label Stack** or **Experimental Bits**.

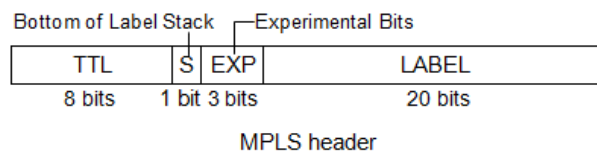

VLAN

Enter the number of VLAN Priority and VLAN ID. You can select **CFI Flag**.

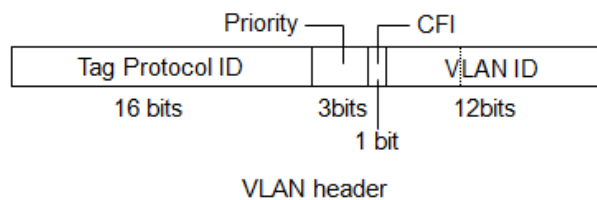

6.1.3 Status Information

This section describes the status information available in the status area of the Ethernet ports setup screen.

6.1.3.1 Status Summary

The status summary displayed for the Ethernet interface consists of the following information:



The actual summary information displayed depends on the type of the Ethernet interface.

Physical Status

The topmost part of the status area gives you access to information about the current physical status of the selected interface. A summary consisting of the most relevant status indicators is displayed constantly. By touching the summary, you can launch a display that contains the detailed status information.

Interface Status

The middle part of the status area gives you access to alarm and error information for the selected interface. The status is indicated by the lamp color. You can choose whether to view only the current alarm and error status, or to view all alarms and errors in the alarm trap since it was last reset.

A summary consisting of the most relevant alarm/error indications is displayed constantly. By touching the summary, you can launch a display that contains all alarms/errors.

Monitor Buttons

At the bottom of the status area are the following buttons that give you access to various monitor information. By touching a button, you can launch the corresponding information display.

- SyncE
- IEEE 1588v2
- OAM
- OH Capture
- Frame Capture
- Transceiver

6.1.3.2 Physical Details

Touching the topmost summary box in the status area of the **Ports Setup** screen displays the status shown below.

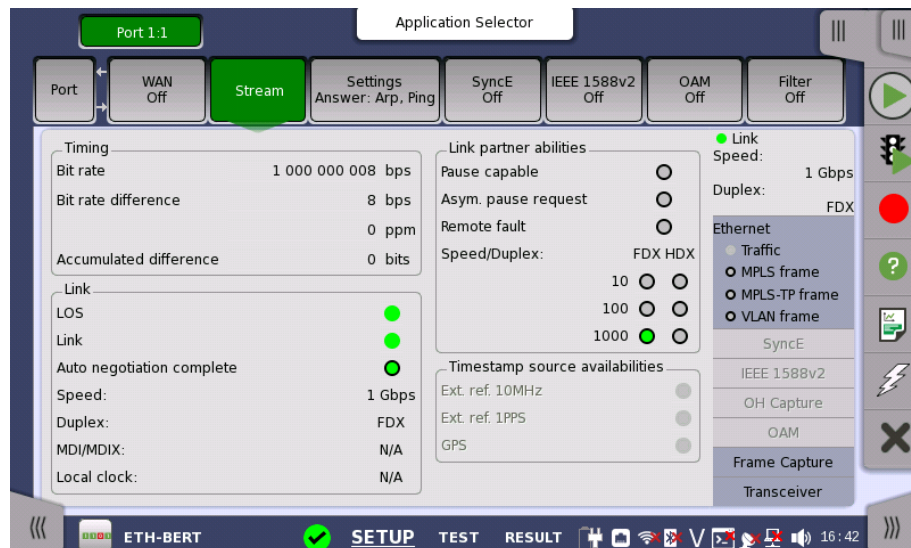

This screen presents detailed information about the current physical status of the received signal at the Ethernet interface.

The physical status information consists of the following parameters:

- [Bit rate](#), which shows the current bit rate.
- [Bit rate difference](#), which shows the difference in bit rate between received signal and reference source signal.

- [Accumulated difference](#), which shows the accumulated bit rate difference between the received signal and the reference source signal.
- [Link](#), which shows the link status of Ethernet.
- [Link partner abilities](#), which shows the abilities of the opposite interface port. (Only available for Electrical)
- [Timestamp source availabilities](#), which shows the status of the external signals used for timestamp.

Timing

Bit rate

The currently received bit rate is shown in bits per second (bps).

Bit rate difference

The current difference between the received signal and the reference source signal is shown in both parts per million (ppm) and bits per second (bps).



External input

- Ext. ref. clock
- Ext. ref. 1PPS
- 1PPS

Ethernet

- Traffic
- MPLS frame
- MPLS-TP frame
- VLAN frame

*In Sync Test application, when **Ext. ref. clock** lights on green while the 10 MHz clock is input to Ext Clock connector on MT1000A, Bit rate and Bit rate difference results are displayed in every one second period which is synchronized with 10 MHz clock.*

*When **Ext. ref. clock** lights on red, Bit rate and Bit rate difference results are displayed in every one second period which is synchronized with internal 10 MHz clock of MT1000A.*

Accumulated difference

The accumulated difference between the received signal and the reference source signal is shown. The information is presented as number of bits of difference detected over the accumulation period.



This is important information for identifying small frequency differences, which may not be visible by showing the current bit rate difference.

The accumulated difference information is accumulated continuously. The accumulation is reset when measurement is started or restarted.

Link

LOS

Indicates whether LOS (Loss of Signal) of the transceiver is occurred or not.

Link

Indicates whether Ethernet link is established or not.

Auto negotiation complete

Indicates whether Auto negotiation is completed or not.

Speed

10 Mbps, 100 Mbps, 1 Gbps or 10 Gbps is shown.

Duplex

FDX: Full Duplex, HDX: Half Duplex.

MDI/MDIX

MDI: Medium Dependent Interface, MDIX: Medium Dependent Interface Crossover

Local clock

Master or Slave is shown.

Link partner abilities When *Electrical* interface type is selected, the Link partner abilities is shown.

Pause capable

Indicates in green when the device is capable of flow control using Pause request.

Asym. pause request

Indicates in green when the device is capable of asymmetric flow control using Pause request.

Remote fault

Indicates in red when the device is sending the remote fault signal.

Speed/Duplex

Available speed and duplex are indicated in green.

Timestamp source availabilities

The status indicators for the external signal used as time stamp are displayed. This area is available and indicators turn green or red if both of the following conditions are met. The status that becomes available varies depending on the setting for **Source** in Stream - Meas screen. The status of the external signals used for timestamp is shown.

- In the Stream Measurement area of the Stream tab, one of **Jitter**, **Latency**, and **Service disruption** is selected.
- In the Stream Measurement area of the Stream tab, other than **Internal** is selected.

Ext. ref. 10MHz

Green: The external 10 MHz clock is available.

Ext. ref. 1PPS

Green: The external 1 PPS reference signal is available.

GPS

Green: The GPS input is available.

Red: The GPS input is not available. If "Sync for 30s" is displayed, it takes 30 seconds from inputting the GPS signal to turning the indicator green. In case it stays in red after 30 seconds elapsed, confirm the connection between the Network Master and the GPS.

6.1.3.3 Interface

Touching the middle summary box in the status area of the **Ports Setup** screen displays the status shown below.

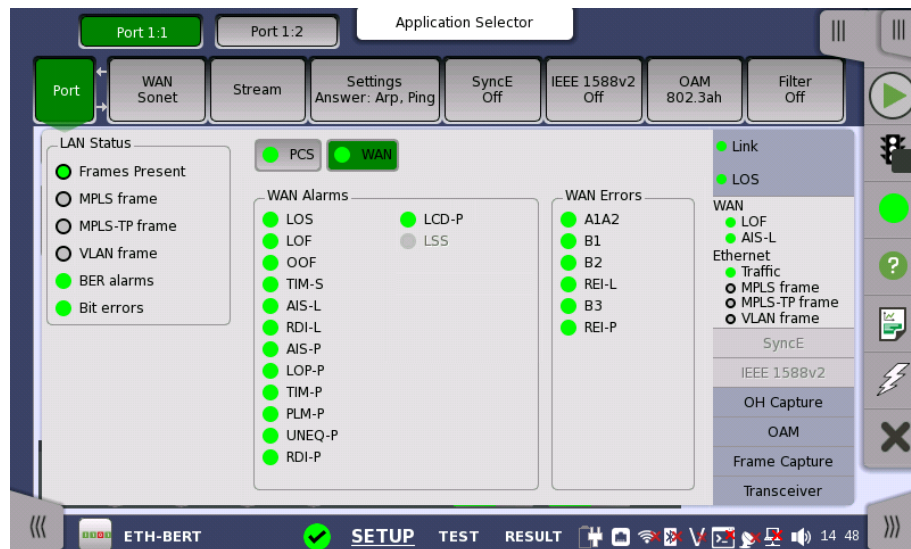

This screen presents key interface status indicators, with [Lamp icons](#) showing the current status. These indicators give a quick overview of the condition of the lines.

LAN Status

- **Frame Present:** Ethernet frames are detected.
- **MPLS frame:** Label of MPLS (Multi-Protocol Label Switching) is detected.
- **MPLS-TP frame:** Label of MPLS-TP (Multi-Protocol Label Switching Transport Profile) is detected.
- **VLAN frame:** Virtual LAN tag is detected.
- **Multi stream frame loss:** Multi stream frame loss is detected.
- **BER alarms:** BER Alarms are detected.
- **Bit errors:** Bit errors are detected.

Multi stream frame loss appears in case of Mon./Gen. application.

View mode

Status display other than **LAN Status** can be switched by touching a button. You can select the status to display from following items:

- WAN
WAN button appears when Port is set to **10 Gbps WAN**.
- PCS
PCS button appears when the Interface Type bit rate is 10 Gbps or higher.
- Sync Test
Sync Test button appears when Sync Test application is running.

The icon indicating the summary is displayed on each button.

WAN Alarms, WAN Errors

For the detail of items, refer to the following descriptions in "SDH/SONET/PDH/DSn Applications".

- [SDH Alarms](#)
- [SDH Errors](#)
- [SONET Alarms](#)
- [SONET Errors](#)

PCS Alarms

- **LFS local fault:** Local fault is detected.

- **LFS remote fault:** Remote fault is detected.
- **High BER:** High BER is detected. Appears when Port is set to 10 Gbps LAN.

PCS Errors

- **Invalid sync header:** Invalid sync header (Sync bit is 00B or 11B.) is detected.
- **Invalid alignment marker:** Invalid alignment marker is detected.
- **BIP error:** BIP error is detected.
- **Invalid block:** Invalid block is detected.

PCS Status

- **LOBL:** Sync Header Lock is detected.
- **LOAML:** Alignment Marker Lock is detected.

Sync Test Alarms

- **Ext. ref. clock:** The valid external reference 10MHz Clock signal is detected.
- **Ext. ref. 1PPS:** The valid external reference 1PPS signal is detected.
- **1PPS:** The valid 1PPS signal to be measured is detected.

Sync Test Status

- **Clock route:** Displays the clock source used for the IEEE 1588v2.
 - **System route:** Internal clock that is generated by system.
 - **10MHz external reference clock:** The 10 MHz clock input to *Ext Clock* connector of MT1000A.

FEC Status

- **LOFA:** Loss of frame alignment
- **Corr. CW:** Corrected Codewords
- **Uncorr. CW:** Uncorrected Codewords
- **FEC symbol errors lane 0 - 3:** Symbol error(s) in each lane.

6.1.3.4 OH Capture

This function is enabled when interface is set to **10G WAN**. Touching the **OH Capture** button in the status area of the **Ports Setup** screen launches the dialog box similar to the SDH/SONET OH Capture screen.

Refer to [OH Capture](#) in the "SDH Setup and Status" section.

6.1.3.5 SyncE

Touching the **SyncE** button in the status area of the **Ports Setup** screen displays the status shown below.

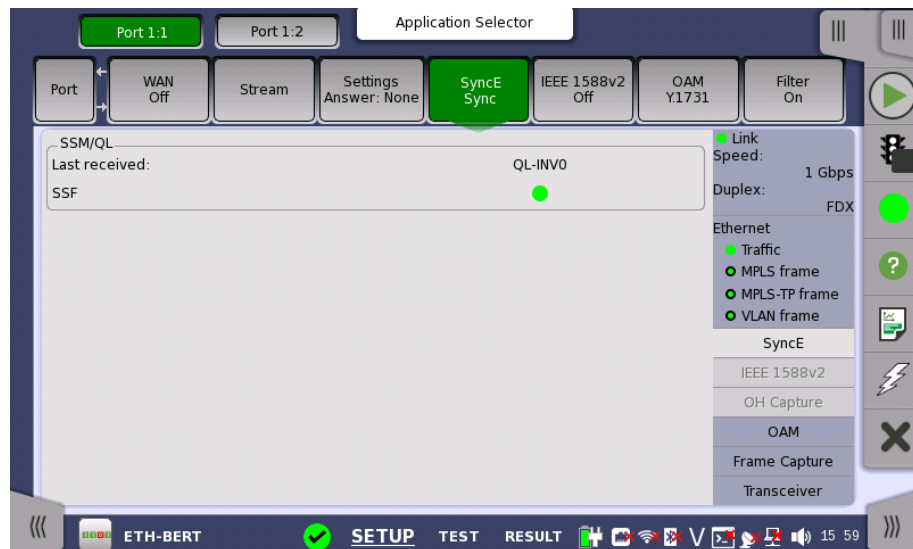

This screen presents information related to the status of synchronous Ethernet.

SSM/QL

Synchronization Status Message and *Quality Level* status

Last received

Shows the latest QL value.

SSF

Server signal fail. The Lamp icon becomes red when no ESMC message has been received within the last five seconds.

6.1.3.6 IEEE 1588v2

Touching the **IEEE 1588v2** button in the status area of the **Ports Setup** screen displays the status shown below.

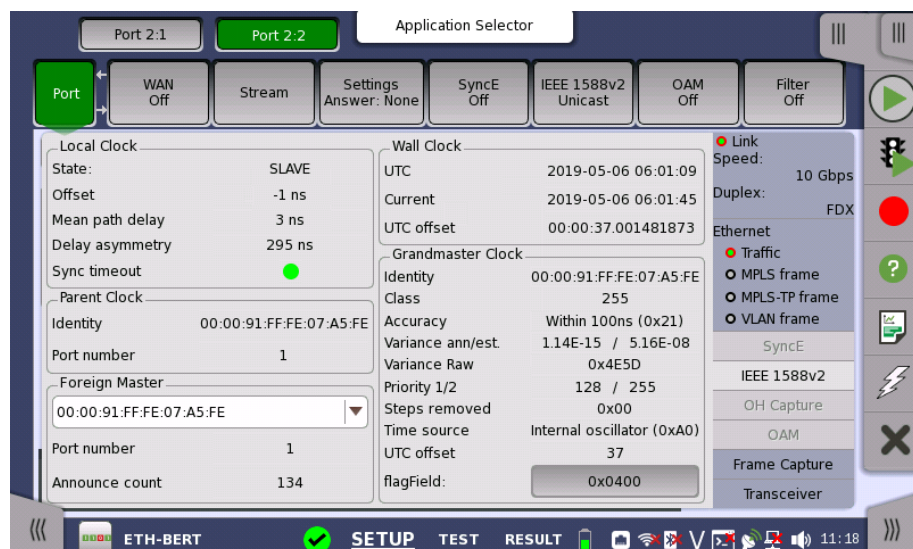

This screen presents information about the status of the IEEE 1588 clock.

Local Clock

State

Shows the current clock state of the ports (**MASTER/SLAVE**). **INIT.** appears when a unicast slave is stuck in INIT-state until the master clock grants access.

Offset

Shows the current offset from the master clock.

Mean path delay

Shows the mean path delay, which is the time from master to slave back to master again, divided by two.

Delay asymmetry

Shows the value calculated from the received INTERFACE RATE TLV only when profile is set to G.8275.2.

For details, refer to the standards listed on the [Profile option](#) tab.

Sync timeout

Shows the current status of Sync Message reception. The Lamp icon becomes red if no Sync Message has been received within five times the Sync interval.

Parent Clock

Identity

Shows the identity of a slave's parent clock.

Port number

Shows the port number of a slave's parent clock.

Foreign Masters

Provides a list of detected foreign masters. The identity of the current master is shown in the field, the other masters are listed in a drop-down menu.

Port number

Shows the port number of the currently selected foreign master.

Announce count

Shows the number of Announce Messages received from the currently selected foreign master.

Wall Clock

UTC

Shows the current UTC time. Requires an external GPS receiver.

Current

Shows the current wall clock time.

UTC offset

Shows the offset between the wall clock time and the UTC time. This is available when the GPS is used as reference.

Grandmaster Clock

Identity

Shows the identity of the grandmaster.

Class

Shows the class of the grandmaster. Ql is displayed together, depending on [SyncE](#) Ql type, profile, and class value.

Accuracy

Shows the accuracy of the grandmaster. The hexadecimal value of the accuracy in the PTP packet data is displayed right-hand.

Variance ann/est.

Shows the offset variance of the grandmaster. Both the announced value and a calculated estimate are shown (in s^2).

Variance Raw

Shows the offset variance of the grandmaster in hexadecimal.

Priority 1/2

Shows priority 1 and 2 of the grandmaster.

Steps removed

Shows the number of communication paths traversed between the local clock and the grand master clock.

Time source

Shows the time source. The hexadecimal value of the time source in the PTP packet data is displayed right-hand.

UTC offset

Shows the UTC offset provided by Announce Message from the Groundmaster clock.

flagfield

Shows the flag field of the announce message in hexadecimal. To see details, touch the button.

6.1.3.7 OAM

Touching the **OAM** button in the status area of the **Ports Setup** screen displays the status shown below.

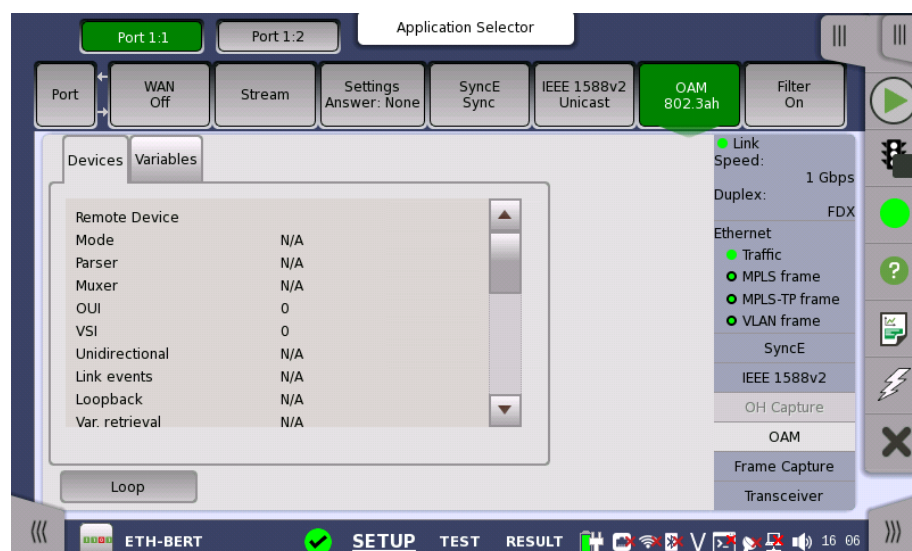

This screen presents information about the status of the OAM functions. The information is split up on a number of tab pages. Note that the layout of the dialog depends on the currently selected OAM protocol.

802.3ah status information

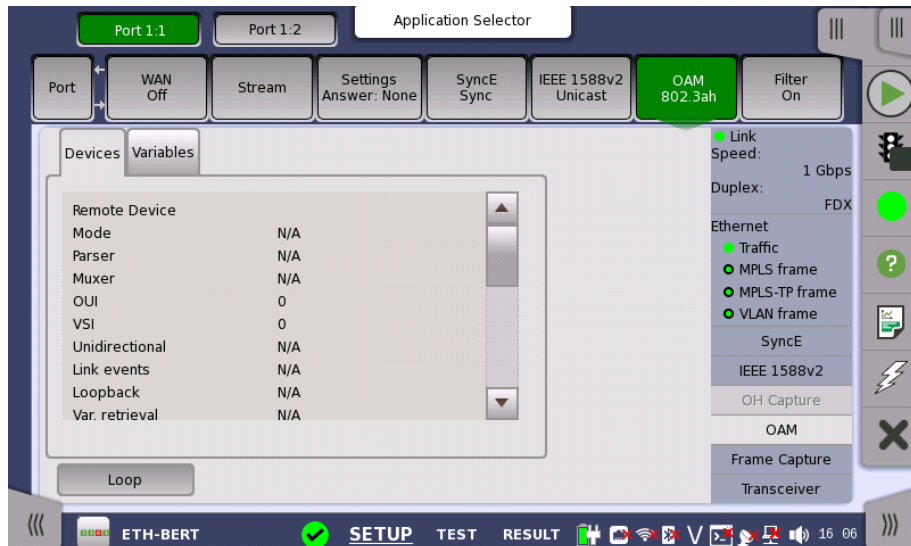

Loop button

Touch the **Loop** button to send the far-end device into loopback mode and reflect frames.

Devices tab page

Shows the status of the remote and local devices.

Variables tab page

On the **Variables** tab page you can request various variables. Select the relevant variable from the drop-down menu and then touch the **Request** button.

802.1ag status information

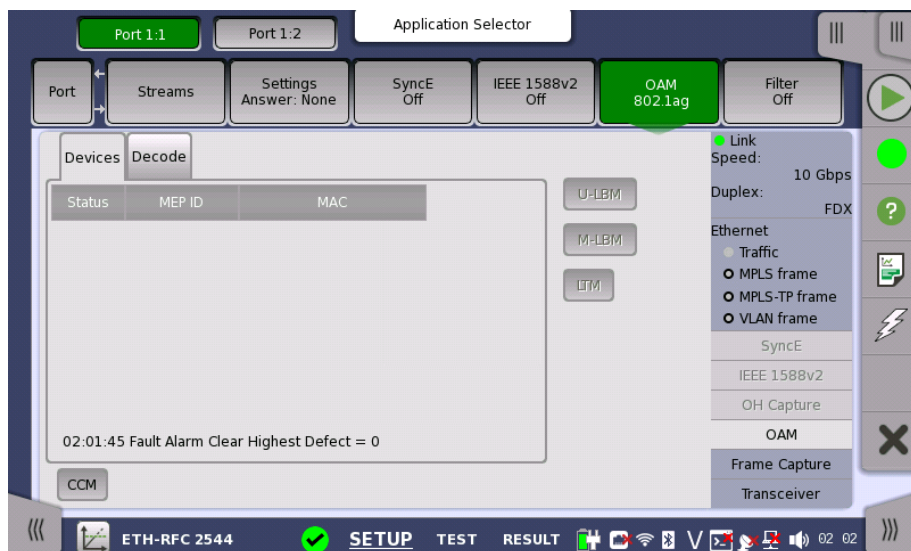

Message buttons

Allows you to send messages either to a remote MEP ID or to a unicast MAC Address.

- **U-LBM**: Data-path integrity to/from the far-end to/from one address (unicast).
- **M-LBM**: Data-path integrity to/from the far-end to/from multiple addresses (multicast).

- **LTM**: Enumerate and identify all hops between two end points.

Fault button

The fault messages are sent when the button is active.

- **CCM**: Continuity Check Messages.

Devices tab page

Shows the current status of the devices.

The outer circle of the colored Lamp in the Status column represents the CCM status (green means that CCMs are received from that RMP, red means no CCMs are received). The inner circle indicates whether the RDI bit in the CCM frame is set (red) or not set (green).

Decode tab page

Shows extra information about LTM frames.

Y.1731 status information

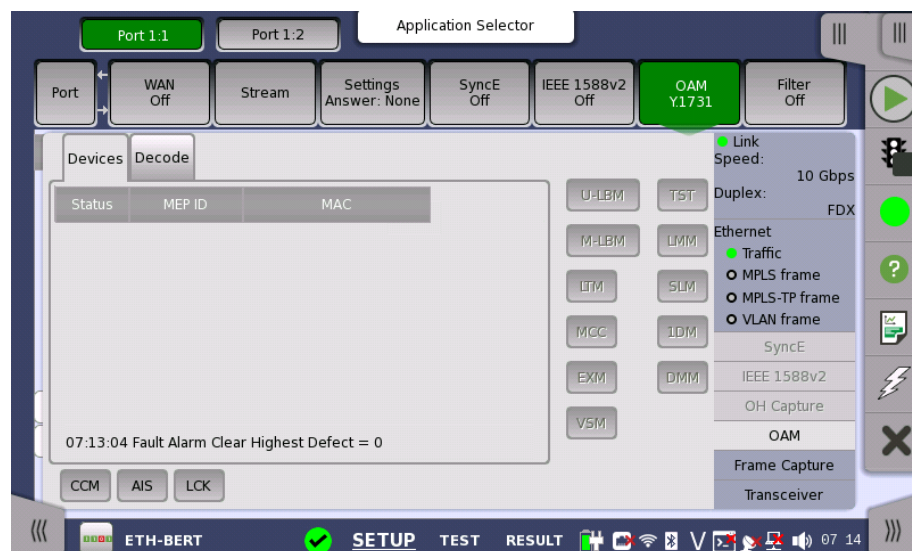

Message buttons

Allows you to send messages either to a remote MEP ID or to a unicast MAC Address.

- **U-LBM**: Data-path integrity to/from the far-end to/from one address (unicast).
- **M-LBM**: Data-path integrity to/from the far-end to/from multiple addresses (multicast).
- **LTM**: Enumerate and identify all hops between two end points.
- **MCC**: Maintenance communication channel message.
- **EXM**: Experimental message and response.
- **VSM**: Vendor-specific message and response.
- **TST**: Test message used for Bit Error Rate measurement and /or throughput measurement.
- **LMM**: Determine packet loss.
- **SLM**: Determine frame loss.
- **DM1**: One-way delay measurements.
- **DMM**: Propagation delay between two end points.

Fault buttons

The fault messages are sent when the button is active.

- **CCM:** Continuity Check Messages.
- **AIS:** Alarm Indication Signal.
- **LCK:** Locked Signal Function.

Devices tab page

Shows the current status of the devices.

The outer circle of the colored Lamp in the Status column represents the CCM status (green means that CCMs are received from that RMP, red means no CCMs are received). The inner circle indicates whether the RDI bit in the CCM frame is set (red) or not set (green).

Decode tab page

Shows extra information about the various frame types.

6.1.3.8 Frame Capture

Touching the **Frame Capture** button in the status area of the **Ports Setup** screen launches the screen shown below.

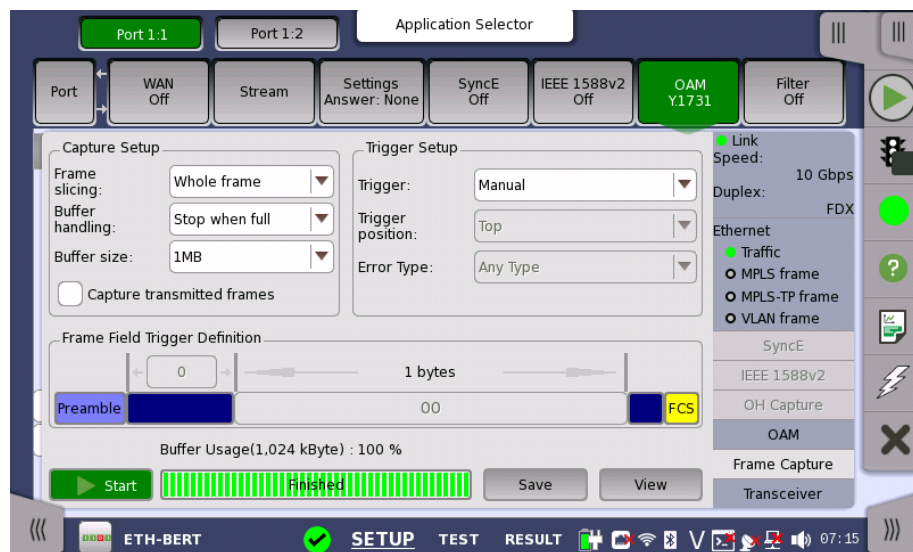

This screen allows you to set up and execute capture of transmitted frames.

Capture Setup

Frame slicing

Use the **Frame slicing** drop-down menu to specify which part of the frame will be captured. The available options are: **Whole frame**, **Top 64 Byte**, **Top 128 Byte**.

Buffer handling

Use the **Buffer handling** drop-down menu to choose either **Stop when full** or **Overwrite**.

Buffer size

Use the **Buffer size** drop-down menu to specify the size of the buffer. The specified size will be reflected in the **Buffer Usage** indicator at the bottom of the screen.

Capture transmitted frames

Select the check box if capturing the transmitted frames.

Clear the check box to capture the incoming frames.



During the 10 Gbit/s rate state, transmitted streams the traffic generator sends can't be captured.

Transmitted protocol frames can be captured. 'Protocol frames' are the frames which used for information such as ARP, SyncE, IEEE1588v2, OAM.

This is the same for 10GbE over OTN (OTU2e - 10GbE mapping).

Trigger Setup

Trigger

- Manual
This is the default setting, which captures all frames. All other trigger setup parameters are disabled.
- Error
Frame capture starts when the error specified by **Error Type** drop-down menu has occurred.
- Field match
Frame capture starts if the field in transmitted frame matches to one defined by **Frame Field Trigger Definition**.

Trigger position

Select the position of a trigger frame in the captured data.

- Top
The trigger frame will be located at top of the captured data.
- Middle
The trigger frame will be located at center of the captured data.

Error Type

The possible values are: **Any Type, Fragment, Oversized or undersized, Oversized, Undersized, FCS error, Oversized & FCS error and IP checksum error.**

Frame Field Trigger Definition

Touching the left field opens the **Field offset** dialog box, which enables you to specify a value between **0** and **15999** in the field.

Touching the center field opens the **Pattern Editor** dialog box, which enables you to specify the relevant pattern in the field.

Capturing frames

Start/stop capture

Touch the **Start** button to start the capturing. The button changes to the **Stop** button. Capture progress is shown in **Buffer Usage**.

To stop the frame capture, touch the **Stop** button.

Save capture data

When the capture is complete, you can save the captured data as a PCAP file, which can be used by a variety of open-source decoding tools. You can also save the data and then view them on the Network Master.

Touching the **Save** button allows you to create a PCAP file and view the data on the Network Master. Touching the **View** button allows you to view the data on the Network master.



When saving capture files using the MX100001A MT1000A/MT1100A Control Software, the destination folder is automatically set to the "Internal" folder of the Network Master.

6.1.3.9 Transceiver

Touching the **Transceiver** button in the status area of the **Ports Setup** screen displays the status shown below.

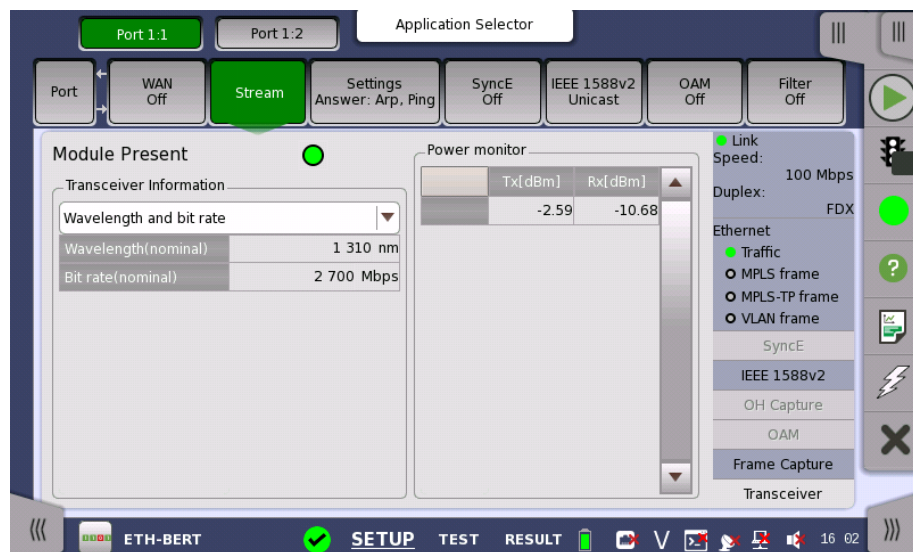

This screen presents status information about the optical transceiver (Pluggable module installed on the connector panel).

When the optical transceiver is SFP or SFP+, [I2C analysis](#) appears.

When the optical transceiver is QSFP+ or QSFP28, [I2C analysis](#) and [Settings](#) appear.

When the optical transceiver is CFP4, [MDIO analysis](#) and [Settings](#) appear.

Module Present

Green indicates that an optical transceiver is currently mounted.

Transceiver Information

Select the information from pull down menu. **Alarm** and **Output control** appear in case of 40GbE or 100GbE.

- **Alarm** shows the alarm status.
- **Wavelength and bit rate** shows the nominal wavelength and bit rate.
- **Compliance** shows the available standards.
- **Vendor information** shows the data stored in the optical transceiver.
- **Output control** allows to select lanes to insert alarm/errors.

Tune wavelength

When the optical transceiver is a tunable SFP, the following items are displayed for **Wavelength and bit rate**.

Bit rate, Channel, Wavelength, Frequency, First frequency, Last frequency, Grid spacing

Transceiver Information	
Wavelength and bit rate	
Bit rate(nominal)	11 300 Mbps
Channel	36
Wavelength	1552.50 nm
Frequency	193.1000 THz
First frequency	191.3500 THz
Last frequency	196.1000 THz
Grid spacing	50.0 GHz

Touching **Channel** or **Wavelength** value opens the dialog box to set the wavelength.

Power monitor

The optical power read out from the transceiver is displayed.

The transmitting optical power or current is displayed in left column. The received optical power is displayed in right column.

In case of 40GbE and 100GbE, the total optical power and the optical powers by each lane are displayed.

The screenshot shows the 'Power monitor' dialog box. It contains a table with the following data:

	Tx[mA]	Rx[dBm]
Total	27.644	N/A
Lane 0	6.874	N/A
Lane 1	6.768	N/A
Lane 2	7.122	N/A
Lane 3	6.880	N/A

Other visible elements include 'Module Present' (green dot), 'Alarm' (Loss of signal), and various system icons at the bottom.

I2C analysis

When the transceiver is SFP or SFP+, touching the **I2C analysis** button at the bottom corner displays the dialog box below.

The screenshot shows the 'I2C analysis' dialog box. It has two main sections: 'Read / Write' and 'Burst Read'.
 - **Read / Write:** Includes fields for Memory (A0h), Page select (00h), Address (0d), and Value (00h). It has 'Read' and 'Write' buttons and an 'Initialize' button in the 'Setup Module' section.
 - **Burst Read:** Includes fields for Memory (A0h), Page select (00h), Address (0d), and Length (128). It has a 'Read' button and an 'Export' button.
 Below these sections is a row of buttons labeled '+0' through '+7'. A 'Close' button is at the bottom right.

This dialog box allows reading/writing information into the registers of the optical transceiver via I²C (Inter-Integrated Circuit) interface.

Registers in the transceiver are defined in *SFF-8472 Specification for Diagnostic Monitoring Interface for Optical Transceivers* and *SFF-8690 Specification for Tunable SFP+ Memory Map for ITU Frequencies*.

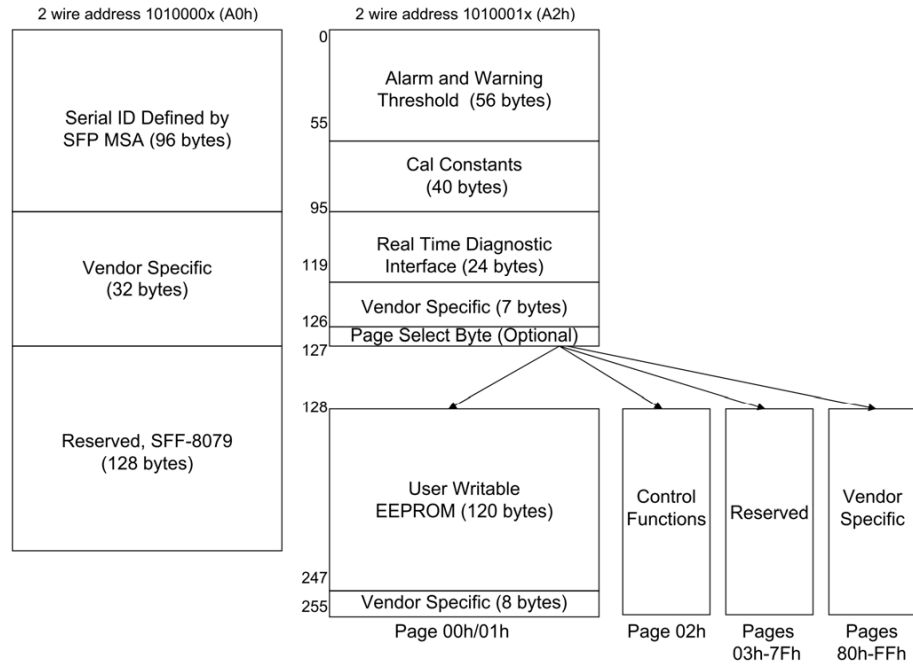

SFP Memory Map

- **Memory A0h** shows information in Memory A0h.
- **Memory A2h** shows information in Memory A2h.
- **Read/Write** allows you to read or write values to the specified registers.

Read/Write

Read/Write allows you to read or write values to the specified registers.

Setup Module

Touching the **Initialize** button initializes register values in the transceiver.

Read/Write

Specifying the address and the page allows users to read or write the data.

Burst Read

Specifying the top address, page, and length allows users to read the data. Touching the **Export** opens the dialog box to save the read data.

I2C analysis

When the transceiver is QSFP+ or QSFP28, touching the **I2C analysis** button at the bottom corner displays the dialog box below.

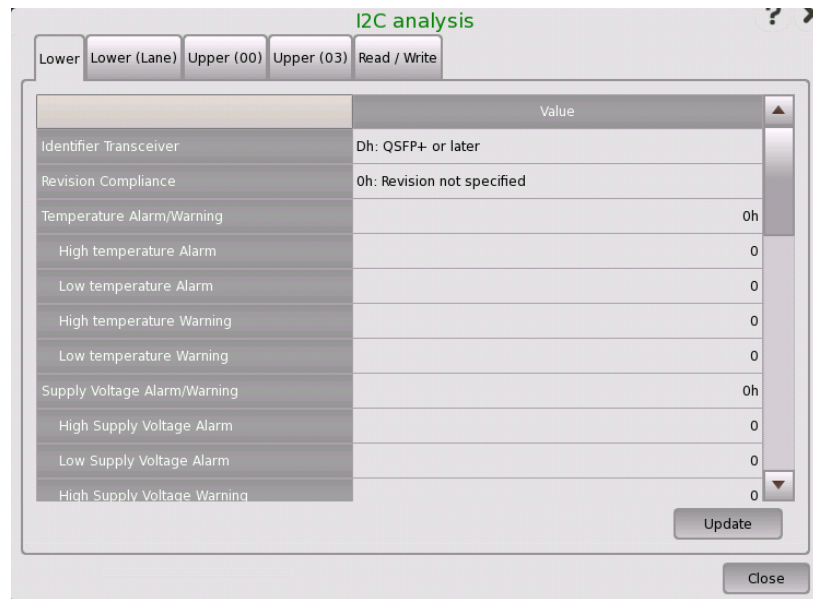

This dialog box allows reading/writing information into the registers of the optical transceiver via I²C (Inter-Integrated Circuit) interface.

Registers in the transceiver are defined in *INF-8438i Specification for QSFP (Quad Small Formfactor Pluggable) Transceiver*.

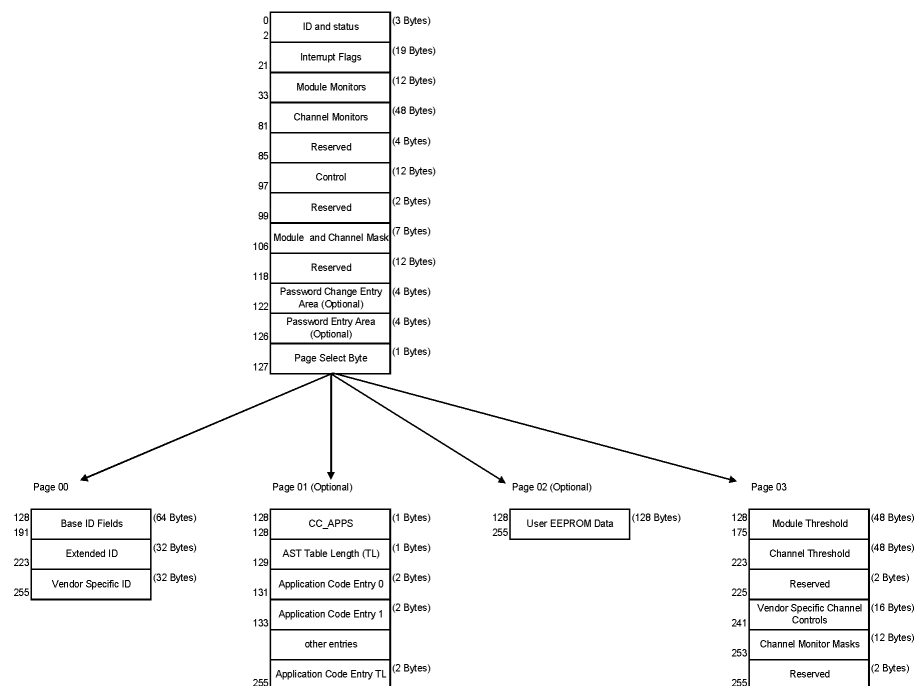

QSFP+ Memory Map

- **LOWER** shows information in lower address registers.
- **LOWER Lane** shows information of each lane in lower address registers.
- **UPPER(00)** shows information in upper address registers (page 00).
- **UPPER(03)** shows information in upper address registers (page 03).
- **Read/Write** allows you to read or write values to the specified registers.

Touching the **Update** button reads the register data of the transceiver.

Read/Write

Single Read/Write

Specifying the address and the page allows users to read or write the data.

Burst Read

Specifying the top address, page, and length allows users to read the data.

Touching the **Export** opens the dialog box to set the filename.

MDIO analysis

When the transceiver is CFP4, **MDIO analysis** button is displayed on Transceiver status screen. Touching the **MDIO analysis** button at the bottom corner displays the dialog box below.

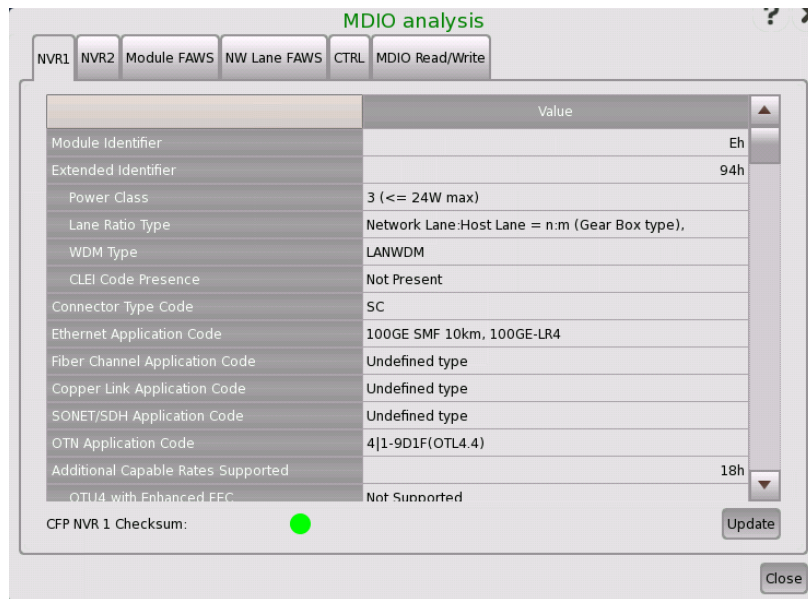

This dialog box presents information reading/writing to the MDIO (Management Data Input/Output) register.

- **NVR1, NVR2** shows Non-volatile Registers.
- **Module FAWS, NW Lane FAWS** shows the fault/alarm/warning/status.
- **CTRL** allows to set CFP pins, the loopback route, FIFO reset or initialization.
- **MDIO Read/Write** allows to set CFP pins, the loopback route, FIFO reset or the initialization.

Touching the **Update** button reads the register data of CFP.

MDIO registers are defined in *CFP MSA Management Interface Specification*.

CTRL

Initialize

Touching **Initialize** button starts starts CFP initialization.



Settings in CTRL tab will be initialized when CFP is removed from the module or CFP power is turned off.

Pin control

Touching the button will switch the output level of CFP pin. Touching **Vcc** button turns on/off the feeding power to the CFP.

FIFO control

Select the check box to set one to the FIFO Reset bit or the FIFO Auto Reset bit.

Loopback control

Select the check box for enabling the loopback function of CFP.

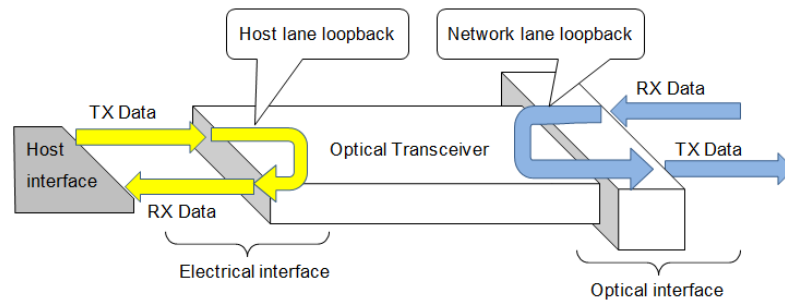

MDIO Read/Write

Single Read/Write

Specifying the address allows users to read or write the data.

Burst Read

Specifying the top address and length allows users to read the data.

Touching the **Export** opens the dialog box to set the filename.

Settings

Touching the **Settings** button at right hand bottom displays the dialog box.

This dialog box allows to set Network Master interface to the optical transceiver.

When setting same value at all lanes, touch the button in **Tracking** column and set the button display to [On]. The value set at Lane 0 is applied to all lanes.

When setting a different value at each lane, touch the button in **Tracking** column and set the button display to [Off]. Set the value by touching the field for each lane.

Transceiver					
	Tracking	Lane 0	Lane 1	Lane 2	Lane 3
Tx					
VOD	Off	0	0	0	0
Pre	Off	0	0	0	0
Post	Off	0	0	0	0
Rx Equalizer					
DFE	Off	1	1	1	1
Insertion loss	Off	0	0	0	0

Default Apply Cancel Ok

Transmitter Interface

Allows to set the output waveform of Network Master.

VOD

VOD (Voltage Output Differential) can be set.

Pre

Emphasis is applied to the bit immediately before where the data changes.

Post

Emphasis is applied to the bit where data changes.

Rx Equalizer

Equalization can be set.

DFE

The mode of boost can be set.

Insertion loss

The gain of the Rx circuit is up to 8 dB in 2 dB steps.

- 0: 0 dB
- 1: 2 dB
- 2: 4 dB
- 3: 6 dB
- 4: 8 dB

6.1.4 Errors/Alarms Insertion

This section describes the errors or alarms insertion for the Ethernet layer on the [Application toolbar](#).

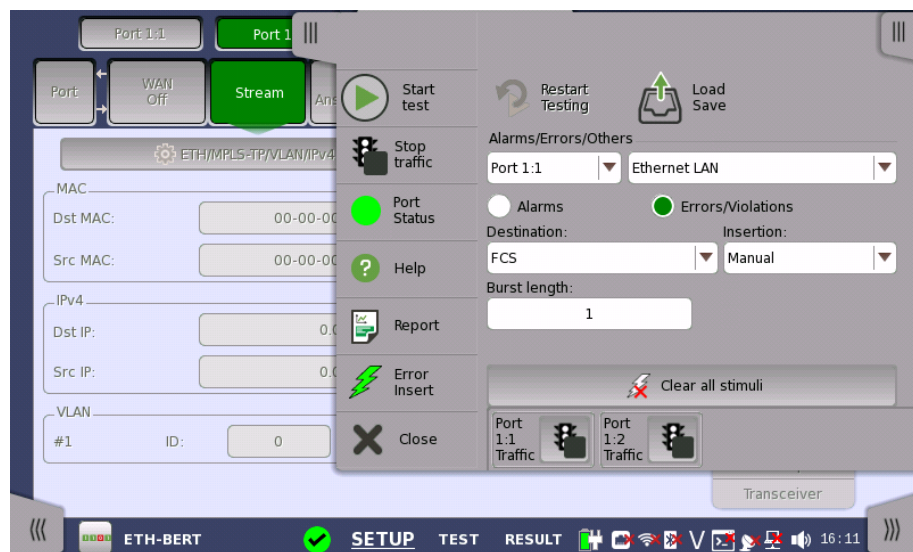

Alarms/Errors/ Others

Select the port to insert errors, and the stimuli type. The settings items vary depending on the selected stimulus type.

- **Ethernet LAN:** Inserts errors or alarms related the Ethernet frame, IP packet or the pattern error.
- **Ethernet PCS alarms/errors:** Inserts errors or alarms to PCS blocks.
- **Ethernet WAN:** Inserts errors or alarms to the WAN header.
- **Ethernet frequency:** Adds the frequency offset to the Ethernet bit rate.

6.1.4.1 Ethernet LAN

1. Select **Alarms** or **Errors/Violations** using the radio button.
2. Select **Destination** using the drop down menu.

3. Select the **Insertion** in case of Errors/Violations.

Alarms will be inserted continuously.

- **Off**: Turns off inserting errors.
- **Manual**: Inserts errors in the specified counts if you touch the Error Insert icon.
- **Burst / sec**: Inserts errors in the specified counts in one second periodic.
- **Burst / 10 sec**: Inserts errors in the specified counts in ten second periodic.
- **Burst*1E-02 to Burst*1E-07**: Inserts errors of burst length in the specified rate continuously.

For example, **Error burst length** is set to 3 and **Burst*1E-06** is selected, the three errors will be inserted per one million blocks. The Error Insert icon shows only status.

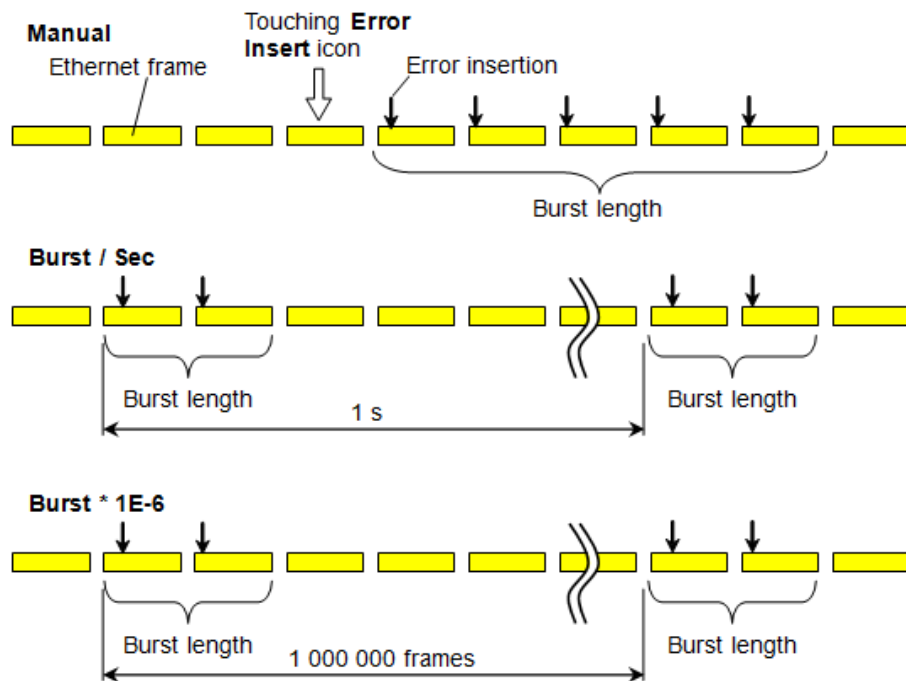
4. Touch the **Burst length** field to set the errors insertion counts.5. When Insertion is set to **Manual**, Touch the Error Insert icon.

Destination	Description
FCS	Sends an Ethernet frame which has FCS error.
Preamble	Sends a preamble in which pattern is different from the normal pattern.
PAUSE frames.	Sends PAUSE frames.
Wrong IP checksum	Sends data which IPv4 Header checksum is wrong.
Fragmented IP	Sends IPv4 data which is fragmented.
Wrong Layer4 checksum	Sends data which checksum in TCP header or UDP header is wrong.
BERT pattern error	Inserts an error into the payload pattern.
BERT Seq. error	Inserts an error into the sequence number which is used to check the pattern sequence in BERT.
Error symbol/block	When the interface bit rate is 10 Gbps, sends data that 64/66B block format in PCS is set to incorrect pattern. When 1 Gbps or less, inserts TX_ER of MII Media Independent Interface).

6.1.4.2 Ethernet PCS alarms/errors

When Port is set to **SFP+ 10 Gbps LAN**, the PCS alarms/errors is available in following applications.

- BERT
 - Mon.Gen.
 - Ch Stat
1. Select **Alarms** or **Errors** using the radio button.
 2. Select the **Destination** inserting the alarm or the error.
 3. Select the **Insertion**.
 - **Off**: Turns off inserting errors.
 - **Manual**: Inserts errors in the specified counts if you touch the Error Insert icon.
 - **Burst**: Inserts errors or alarms in counts you have specified.
 - **Rate**: Inserts errors in the specified rate continuously.
 - **Alternate**: Repeats error/alarm insertion per specified number of frames.
 - **All**: Inserts errors to all Ethernet frames.

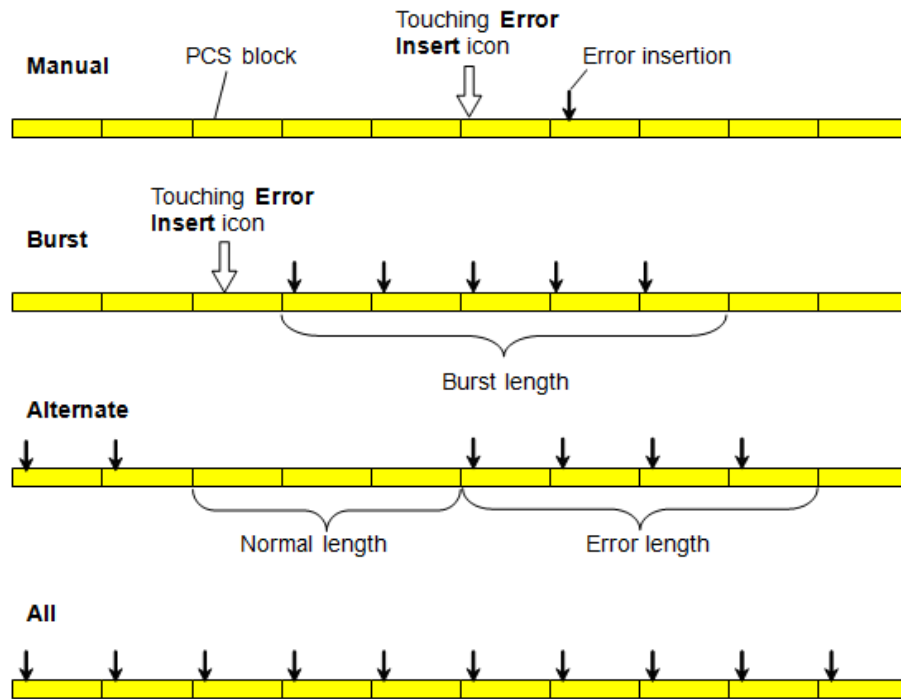

6.1.4.3 Ethernet WAN

When Port is set to **SFP+ 10 Gbps WAN**, inserting the WAN alarms/errors is available.

1. Select **Alarms** or **Errors/Violations** using the radio button.
2. Select **Destination** using the drop down menu.
3. Select the **Insertion** in case of Errors/Violations.
 - Alarms will be inserted continuously.
 - **Off:** Turns off inserting errors.
 - **Manual:** Inserts errors in the specified counts if you touch the Error Insert icon.
4. Touch the **WAN burst length** field to set the errors insertion counts.
5. When Insertion is set to **Manual**, Touch the Error Insert icon.

6.1.4.4 Ethernet frequency

Touch the field to set **Ethernet frequency**. Enter the desired deviation in the Tx Deviation field. A positive value increases the frequency.

6.2 BERT



The Bit Error Rate Test (BERT) described in this section is applicable for Ethernet interfaces.

For BERT of OTN interface, refer to [BERT](#) in "OTN Application".

6.2.1 Ports Setup and Status

The first step in running an application is to set up the port interfaces. This is done on the **Ports Setup** screen, which also provides port status information.

The setup options and status information related to the Ethernet interface are described in a separate section:

- [Ethernet Setup and Status](#)

For applications also including an OTN interface, you can find a description of the setup options and status information for OTN in the following section:

- [OTN Setup and Status](#)

Please refer to the sections relevant for your current port setup requirements.

6.2.2 Test Setup

6.2.2.1 Control

When you go to the test setup of the Ethernet BERT application, the following screen is displayed.

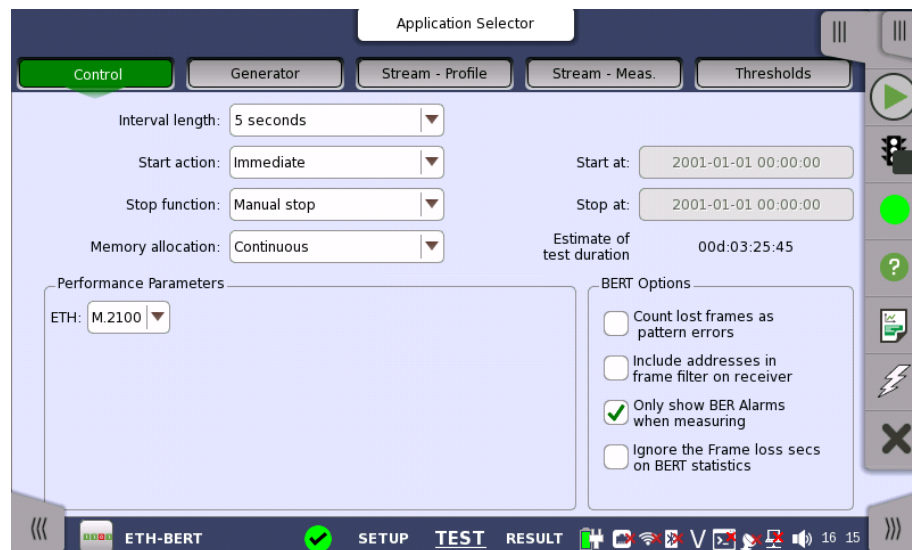

This screen contains the parameters that are generally required in a test setup.

Interval length

Allows you to specify the duration of the BERT intervals. The drop-down menu contains the following values: 1, 2, 5, 10, 15, 30 seconds, 1, 5, 10, 15, 30 minutes, 1, 2, 4, 6, 12 hours or No intervals.

Start action

Allows you to specify when the measurement is started.

- **Immediate:** Starts the measurement when you touch the **Start** button.
- **Start at:** Starts the measurement at the time specified in the **Start at** field on the right.

Stop function

Allows you to specify when the measurement ends. Select the relevant option from the drop-down menu:

- **Manual stop:** Stops the measurement immediately when you touch the **Stop** button.
- **Stop at:** Stops the measurement at the time specified in the **Stop at** field on the right.
- **Duration:** Performs the measurement for the duration of time specified on the right.

Memory allocation

Allows you to specify how the measurement will be stored in the Network Master's memory. Select the relevant option from the drop-down menu:

- **Use all storage:** When Network Master's memory became full of measured data, the whole measurement is stopped.
- **Continuous:** When Network Master's memory became full of measured data, the oldest records in that memory will be overwritten. When the memory became full, it is recorded in [Event log](#).

The Network Master's memory size (the file size of measurement results) is 64 Mbytes per one port. The result file size is less than 64 Mbytes because it is compressed when saving to the file.

Estimate of test duration

Contains an estimation of the time (in days, hours, minutes and seconds) before the whole memory will be filled out by the test. The estimated value is dependent on the current interface and selections concerning this interface. During an ongoing measurement, the estimate will be recalculated periodically, meaning that the estimate will get better and better. The estimate can be seen on the status line during a measurement.

The titles of ITU-T Recommendation are below.

- **G.826** End-to-end error performance parameters and objectives for international, constant bit-rate digital paths and connections
- **G.829** Error performance events for SDH multiplex and regenerator sections
- **G.8201** Error performance parameters and objectives for multi-operator international paths within the Optical Transport Network (OTN)
- **M.2100** Performance limits for bringing-into-service and maintenance of international multi-operator PDH paths and connections
- **M.2101.1** Performance limits for bringing-into-service and maintenance of international multi-operator SDH paths and multiplex sections
- **M.2401** Error performance limits and procedures for bringing-into-service and maintenance of multi-operator international paths and sections within an optical transport network
- **M.2110** Bringing into service international multi-operator paths, sections and transmission systems

Performance Parameters

OTN-related

These items appear if OTN Tx and OTN Rx are selected on Setup screen.

OTN

G.8201, M.2401 (M.2110)

Time period

15 minutes, 1 hour, 2 hours, 24 hours, 7 days

Allocation

Touching the **Setup** button launches the dialog box. Refer to [Performance Parameters](#) in "OTN Application" .

Ethernet-related

10G WAN appears if Port on the Test Setup screen is set to '10 Gbps WAN'.

ETH

M.2100

10G WAN

G.826, G.826+G.829, M.2101.1(M.2100)

BERT Options



This option appears in the BERT application.

Count lost frames as pattern errors

Enabling this function means that if a frame is lost then all test pattern bits in the frame are considered errored and will be included in the pattern error counter.

Include addresses in frame filter on receiver

When enabling this function, the Ethernet frames which their destination addresses match to following items will appear on the [Streams](#) screen.

- Src MAC
- Src IP
- VLAN ID
- Src Port

This setting makes the effect to only following measurement results on the Statistics screen.

BERT	Mon./Gen
BERT	Multi Stream Transmit
Latency	Multi Stream Throughput
Jitter	Multi Stream Frame Loss
	Multi Stream Latency
	Multi Stream Jitter

This setting does not effect to [Frame Capture](#).

Only show BER Alarms when measuring

BER alarms in Interface status dialog box is enabled only when the measurement is running. This function allows to avoid the BER alarms occurrence when no data is input.

Ignore the Frame loss secs on BERT statistics

The "Frame loss secs." on BERT statistics will not be used for judging the Status Summary. This function allows to avoid the [Status Summary](#) alarms occurrence when no frames are input.

6.2.2.2 Generator

Touching the **Generator** button in the navigation area displays the following screen.

The **Follow** button appears when the Port 2 settings can follow Port 1.

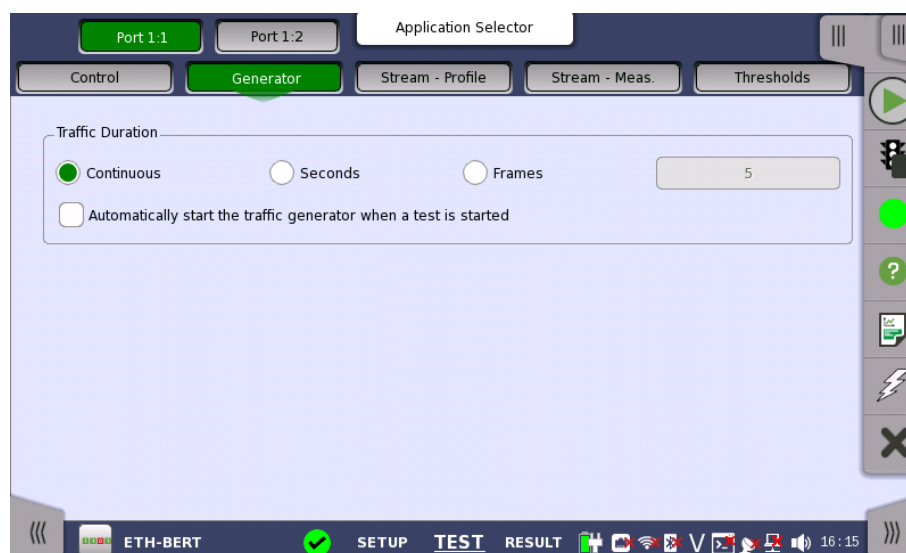

This screen contains the traffic-related parameters.

Traffic Duration

Allows you to set conditions concerning frames transmission. Choosing **Continuous** will make a continual test sequence. Alternatively, the duration can be set manually in either **Seconds** or **Frames**, coupled with a specification of the number of seconds/frames in the adjacent field.

Automatically start the traffic generator when a test is started

In case of **Continuous**, you can select this check box to make the traffic generator start synchronously with the test starting.

6.2.2.3 Stream - Profile

Touching the **Stream - Profile** button in the navigation area displays the following screen.

The **Follow** button appears when the Port 2 settings can follow Port 1.

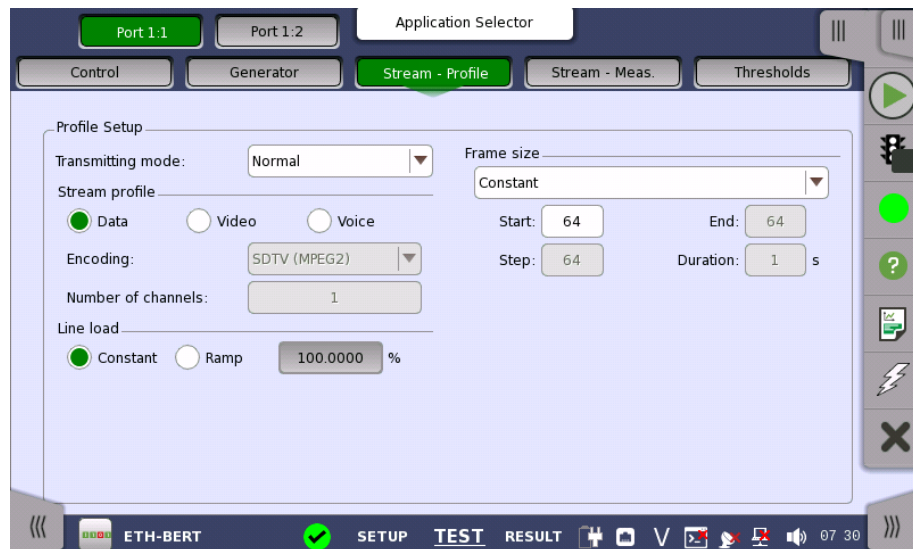

This screen contains the parameters for specifying a profile and pattern for each stream and for specifying which measurements are made.

Transmission mode

- **Normal:** Does not generate the bursts. The normal Ethernet frames are sent.
- **Burst:** Generate the bursts.

Stream profile

Allows you to specify and configure a profile type for the currently selected stream. Using the radio buttons, you can select the stream profile as either **Data**, **Video** or **Voice**.

Encoding

Open the drop-down menu to select the relevant encoding type. The available values depend on the selected profile type.

Number of channels

Specify the number of stream channels selected at Encoding.

Line load

When Profile type is set to **Data**, you can select the line load profile as either **Constant** or **Ramp**. If you select **Ramp**, you can touch the adjacent button to display the **Ramp Line Load Setup** dialog box.

When Profile type is set to **Video** or **Voice**, the line load calculated from Encoding and Number of channels is displayed.

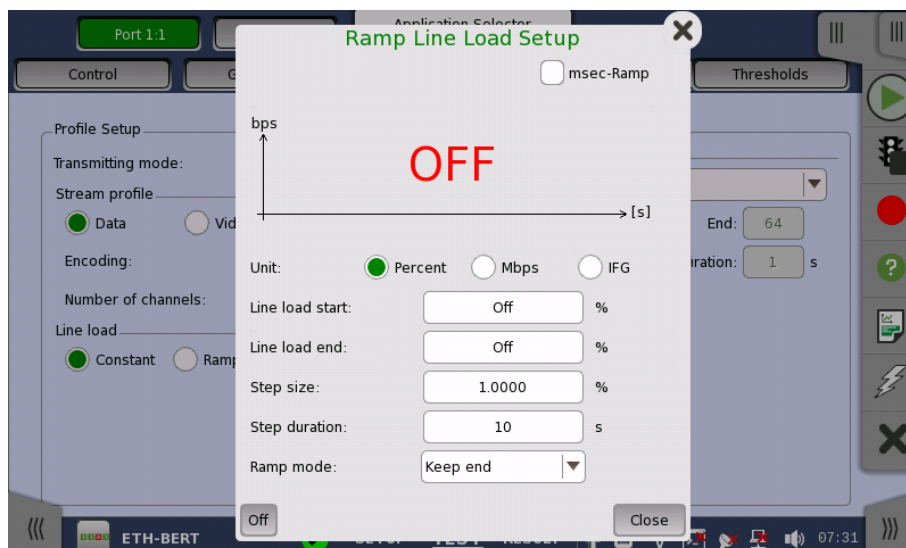

The line load unit can be specified from **Percent**, **Mbps**, and **IFG**. When IFG (Inter frame gap) is specified to the unit, 12 byte setting means the 100% utilization. The value set to the field is an average of Inter frame gap. When Transmission mode is **Normal**, 100% or more line load can be set in specific case.

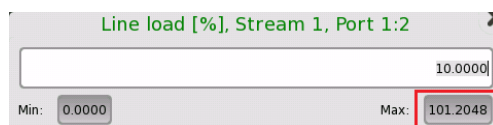

Touching **Off** at left-bottom stops sending the stream.

The dialog box contains the following settings:

Line load start

The line load at which the ramp will start.

Line load end

The line load at which the ramp will end. (This is the value shown on the line load button.)

Step size

The step size from start to end.

Step duration

The duration of each step.

Selecting **msec-Ramp** check box allows to set the step duration in 1 millisecond increments.

Ramp mode

How the ramp should continue. 3 modes are available:

- **Keep end:** The specified end line load is maintained after the ramp is ended.
- **Repeat ramp:** The ramp is repeated.
- **Invert ramp:** The ramp is inverted.

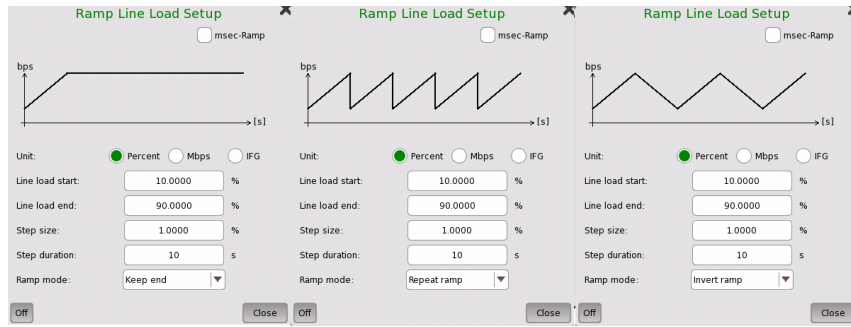

Frame size

When Profile is set to **Data**, four setups are available:

Constant

Uses the fixed frame size specified by the **Start** value for the duration of the test. The following figure shows an example of frame sizes when **Constant** is selected.

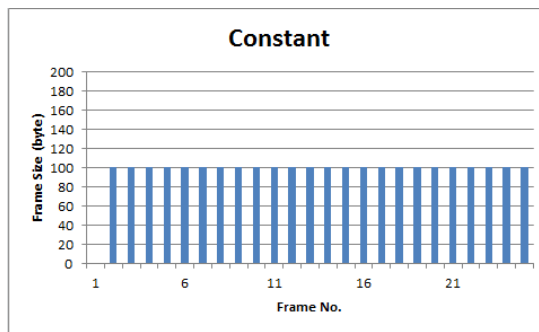

Stepped

Steps the frame size from **Start** to **End** in increments of **Step**. Each frame size is transmitted for the period in seconds specified by **Duration**. The following figure shows an example of frame sizes when **Stepped** is selected.

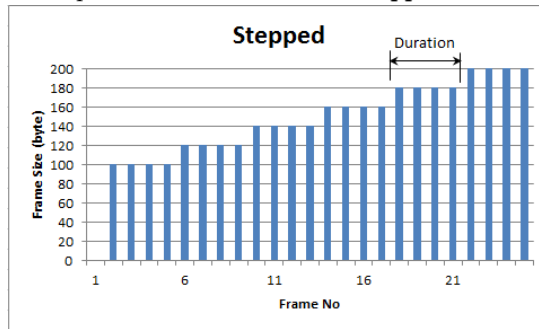

If the traffic duration is set to *Continuous* on the **Generator** screen, the step sequence will be repeated indefinitely. If traffic duration is set to *a number of seconds*, the step sequence will be terminated when the specified total period has elapsed. Similarly for traffic duration set to *a number of frames*, the step sequence will be terminated when the total number of transmitted frames reaches the specified count.

Random

Sends a continuous stream of frames of random sizes, evenly distributed between **Start** and **End**. The following figure shows an example of frame sizes when **Random** is selected.

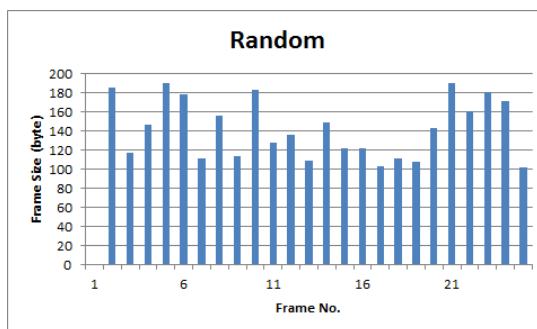

1-Byte incremental

Steps the frame size from **Start** to **End** in increment of one byte in frame-by-frame. The following figure shows an example of frame sizes when **1-Byte incremental** is selected.

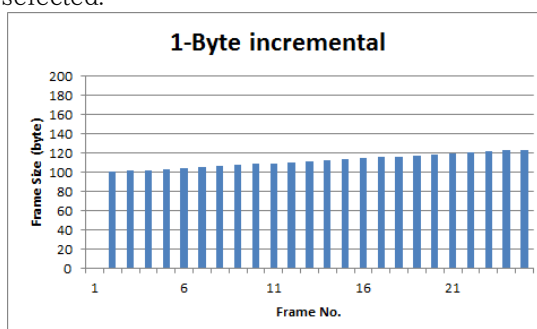

Frame size is protocol headers and payload combined. Frame size does not include preamble and interframe gap.

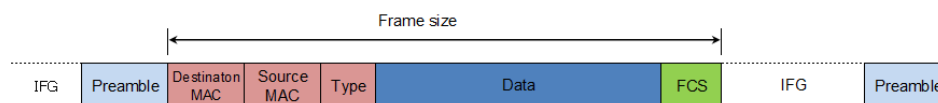

When setting Frame size to 52 byte or less and Interface type is **SFP+**, the actual rate (Utilization) does not reach to 100% even if line load is set to 100%.

Burst mode

Set the burst generation mode. The normal Ethernet frames are not sent in the burst mode.

- **Off**: stops sending the stream.
- **Const**: generates the bursts that the burst length and the gap length are constant.

- **Ramp**: generates the bursts while changing the burst length.

Number of Bursts

Selecting **Num of Burst** allows to set the number of the bursts to generate. If sending specified number bursts has finished, sending stream will stop.

Burst length

Set the burst burst length and the gap length.

- When Burst mode is set to **Const**:
 Touch the field of **Burst length** and **Gap length** to set the value.
 Burst length can also be set by specifying **Duty** and **Period**.

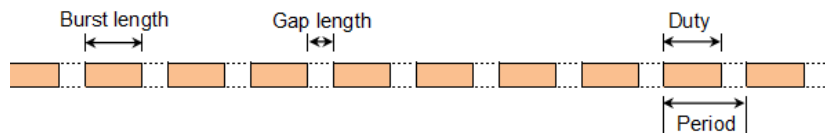

The value set to the **Gap length** field is an average of inter burst gaps.

- When Burst mode is set to **Ramp**:
 Touch the **Ramp mode** field to set how to vary the burst length.
 - If **Keep end** is set, the burst length varies as below.

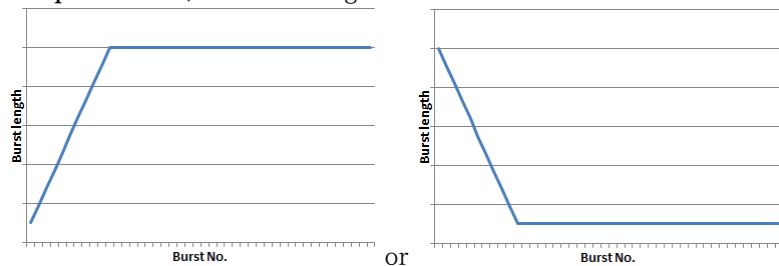

- If **Repeat ramp** is set, the data length varies as below.

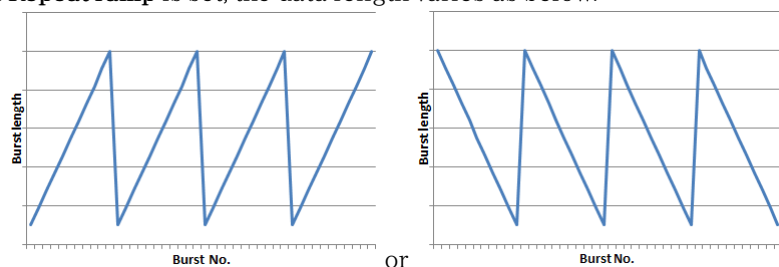

Touch the field of **Burst start** and **Burst end** to set the range that the burst length varies.

Touch the **Gap length** field to set the value. The value set to the **Gap length** field is an average of inter burst gaps.

Frame size

Set the frame size used for the burst length calculation. 20 bytes (preamble and IFG) adding to the value set in this field is used as the one frame size of the burst length setting.

6.2.2.4 Stream - Measurement

Touching the **Stream - Measurement** button in the navigation area displays the following screen.

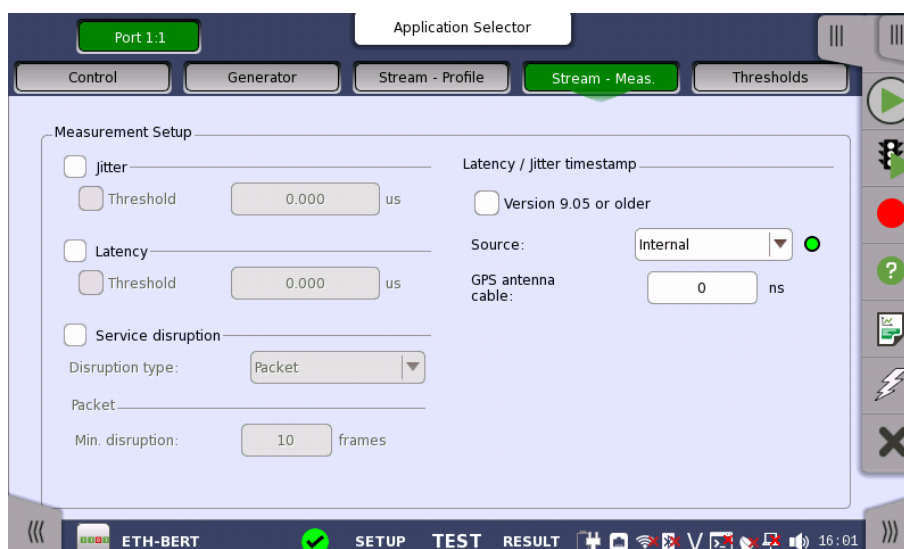

Select one or more of the measurements (**Jitter**, **Latency** and **Service disruption**) and then specify a threshold value for each. This screen allows you to configure **Jitter**, **Latency** and **Service disruption**.

Enable sequence checking

Appears when "Unframed" is selected to the protocol in Stream of *Port Setup* screen.

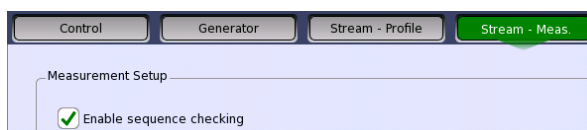

Select the check box if enabling the frame sequence checking.

Jitter

Select Jitter to measure it.

When selecting Threshold and enter the value, Pass/Fail is judged.

Latency

Select Latency to measure it.

When selecting Threshold and enter the value, Pass/Fail is judged.

Service disruption

Select Service disruption to measure it.

Select Disruption Type from **Packet** or **LOS**.

When selecting **Packet**, enter the number of skip of frame number to count service disruption.

When selecting **LOS**, service disruption is counted if one or more LOS is detected.

Enter **Error free period** as time from counting the service disruption to restart it.

Latency / Jitter timestamp

This screen allows you to configure the timestamp of **Jitter**, **Latency** and **Service disruption**.

Version 9.05 or older

When selecting **Version 9.05 or older**, the measurement is performed with a resolution of $0.1 \mu s$ which is the same as the software version of Version 9.05 or older.

It is not available to perform measurement by using Network Masters which have different resolution setup. Make sure to select this if the software version of the Network Master on the opposite side at the facing test is 9.05 or older.

At Ethernet + OTN or WAN measurement, this is automatically selected.

When not selecting **Version 9.05 or older**, the measurement using a GPS can be performed with a resolution of 0.005 μ s depending on "Source" selection.

Source

Select a timestamp source for measurement. The indicator on the right notifies you whether latency and/or jitter can be measured.

Green: Latency and/or jitter can be measured.

Red: There is a possibility that the timestamp source signal could not be detected. For the detection status of the timestamp source signal, refer to

[Timestamp source availabilities](#).

Only when MU100011A is installed and **Version 9.05 or older** is NOT selected, **GPS (Ext ref. 10MHz)**, and **1PPS(Ext ref. 10MHz)** can be selected.

When **GPS, 1PPS(Ext ref. 10MHz)**, or **GPS(Ext ref. 10MHz)** is set, the measurement can be performed by using two Network Masters which have made synchronized.

In this case, set the same option to **Source(Ext ref. 10MHz)** of both Network Master.

Round Trip time and One Way Latency can be measured by setting Source in combination show in the table below.

Module Model	Round Trip time	One Way Latency	
	Source	Source	GPS receiver to be used
MU100010A	Internal	GPS	G0325A or MU100090A
MU100011A	Internal	GPS	G0325A
		1PPS(Ext ref. 10MHz)	GPS receiver provided by other than Anritsu MU100090A*1
		GPS(Ext ref. 10MHz)	MU100090A*2

*1: When the MU100090A is feeding 1PPS and 10 MHz clock to two MT1000As.

*2: When the MU100090A is feeding 1PPS and 10 MHz clock to one MT1000A.

Internal

This option uses the timestamp generated inside the Network Master.

GPS

This option uses the timestamp generated based on TOD (Time of Day) signal and 1PPS signal which are provided by the GPS receiver

G0325A GPS Receiver or MU100090A can be used. The 10 MHz clock provided by MU100090A is not used for generating the timestamp.

One way latency can be measured.

1PPS (Ext ref. 10MHz)

This option uses the timestamp generated based on 1PPS signal and 10 MHz clock which are provided by the GPS receiver. By using 10 MHz clock, the measurement can be performed in higher accuracy than the one when

selecting GPS.

One way latency can be measured.

Due to using 1PPS signal, the latency of one second or less than can be measured.

This option allows users to use other vendor's GPS other than G0325A and MU100090A. In this case, J1705A AUX Conversion Adaptor is required.

GPS (Ext ref. 10MHz)

This option uses the timestamp generated based on TOD (Time of Day) signal, 1PPS, and 10 MHz clock which are provided by MU100090A. By using 10 MHz clock, the measurement can be performed in higher accuracy than the one when selecting GPS.

One way latency can be measured.

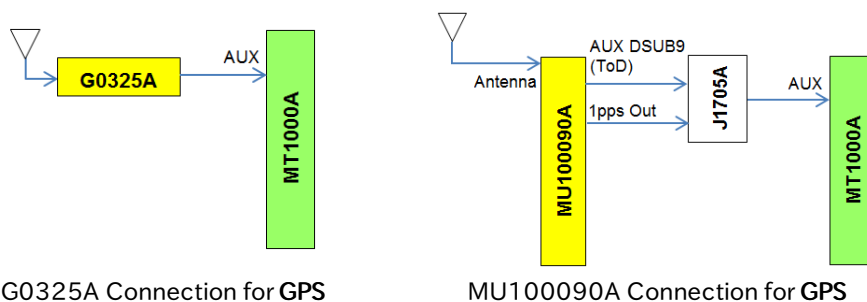

G0325A Connection for GPS

MU100090A Connection for GPS

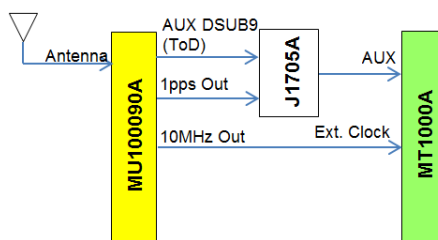

MU100090A Connection for GPS (Ext ref. 10MHz)

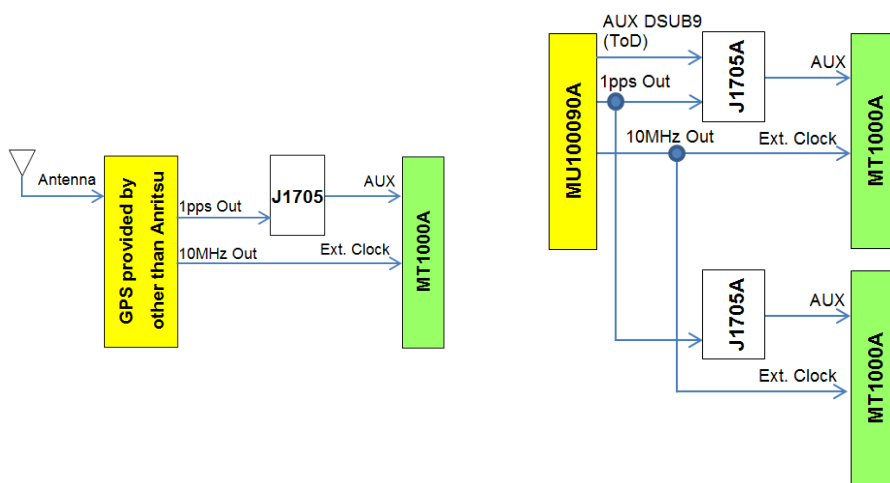

Connection of GPS provided by other than Anritsu for 1PPS(Ext ref. 10MHz)

Connection of MU100090A and Two MT1000As for 1PPS(Ext ref. 10MHz)

GPS antenna cable

To measure the phase error precisely, set the correction value to GPS cable correction.

When calculating the delay time from the cable length, it is recommendable to use 5 ns/m as the conversion factor.

When using the following GPS provided by Anritsu, set 25 ns.

- G0325A
- MU100090A (When using J1706A GPS antenna of the standard accessory)

6.2.2.5 Thresholds

Touching the **Thresholds** button in the navigation area displays the following screen.

The **Follow** button appears when the Port 2 settings can follow Port 1.

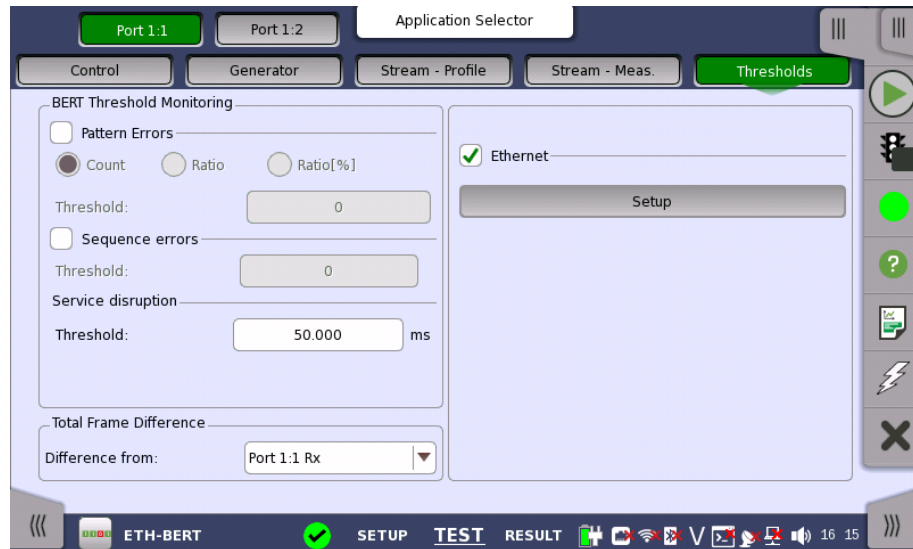

This screen contains the parameters for setting up the various threshold values (i.e. limits) for errors and Pass/Fail status that are used during the monitoring.

Pattern Errors

Allows you to enable monitoring of pattern errors (i.e. bit errors) and to set up a threshold value for the bit error ratio.

Choose whether the threshold is specified as an absolute value or a percentage, using the **Count**, **Ratio** and **Ratio (%)** radio buttons, and then specify the value in the **Threshold** field.

Sequence errors

Allows you to enable monitoring of sequence errors and to set up the relevant threshold value.

Service disruption

If you specify a threshold value for the service disruptions (using the **Threshold** field), any disruption whose maximum duration time exceeds the threshold value will be marked in red on the Test Result screen.

Total Frame Difference

Allows you to select the reference port to measure the differential time, using **Difference from:** drop down menu.

Transport

This setting appears in case of following applications on OTN.

- BERT
- Mon./Gen.
- Reflector

When you select the check box, you can enable alarm or error thresholds.

Interface

Fixed to OTN.

Evaluation item

Select the item to evaluate. If selecting other than **Any Alarm** or **Error**, another menu appears.

Evaluation type

Select the relevant type.

Pass & fail threshold

Touch the left-hand number to set the lower limit for "Warning". Touch the right-hand number to set the lower limit for "Fail". The lower limit of "Fail" must be equal to or greater than the lower limit of "Warning" (defining a "Within limits" range in between them).

Ethernet

When you select the check box, you can enable various thresholds. Touch the **Setup** button to display the **Ethernet threshold setup** dialog box.

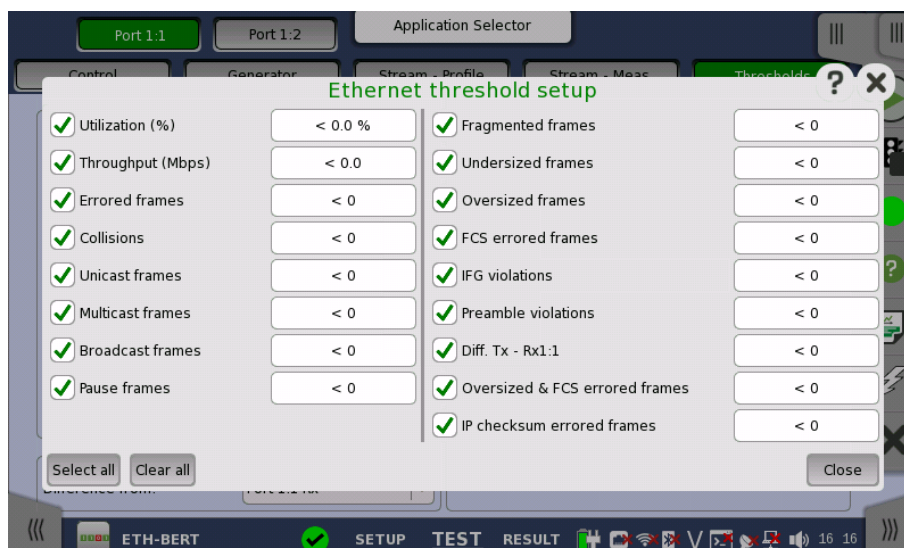

In the dialog box, select the check boxes for the relevant thresholds and then touch the **Close** button to list them on the **Thresholds** screen. You can select/deselect all check boxes in the dialog box by using the **Select all** / **Clear all** buttons. Touch the individual value fields either in the dialog box or in the list on the screen to specify the threshold values.

Example

Setting	Measured Result	
	Pass	Fail
< 100	100 or greater	less than 100
<= 100	greater than 100	100 or less
>= 100	less than 100	100 or greater
> 100	100 or less	greater than 100



The Network Master transmits the 32-bit "jam sequence" eight times when the Ethernet frames collide at any point in the frame. This collision motion is different from the definition of the IEEE Standard. In the "back off" process of the Network Master, the maximum wait time is expanded up to the 12 power of 2. Moreover, the Network Master does not discard the frame when the collision has occurred 16 times.

6.2.3 Test Results

6.2.3.1 Summary

When you go to the test results of the Ethernet BERT application, the following screen is displayed.

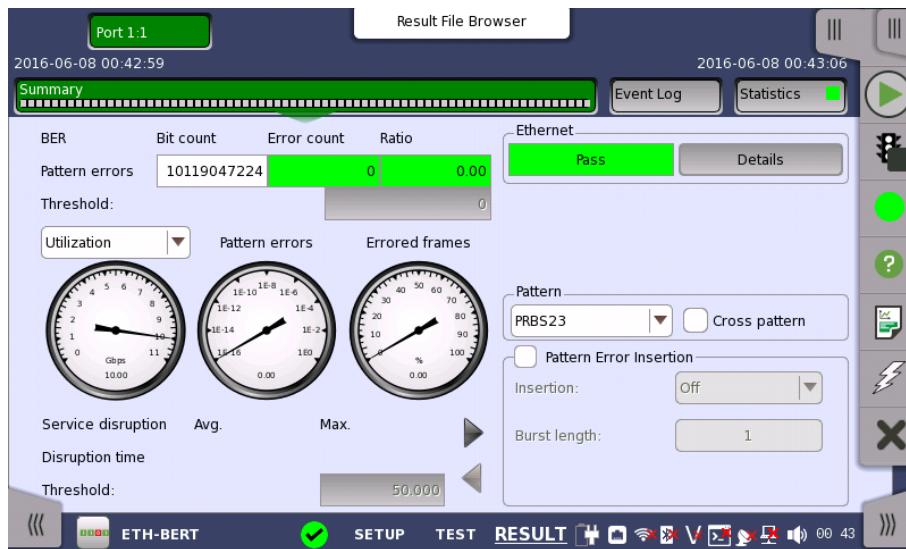

This screen contains a summary of the results of the Ethernet BERT test. The information includes such things as number of pattern errors, average and maximum disruption time, and number of exceeded thresholds.

The three dials showing utilization/throughput results, pattern errors and errored frames can be enlarged by clicking on them. The black needle points the measured value in the latest period.

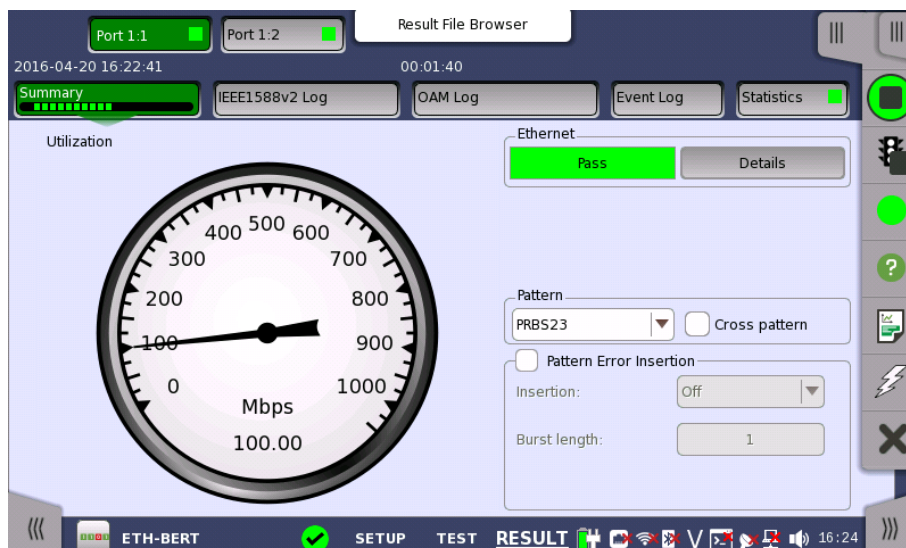

To view throughput information, select **Throughput** in the drop-down menu and then expand the dial. Use the drop-down menu above the expanded dial to select the relevant layer.

When **Ethernet** is selected on 'Threshold' of the Test Setup screen, the **Ethernet** information appears in the upper right-hand corner, shows pass/fail status summary. Touching the **Details** button allows you to inspect the individual pass/fail status.



Transport

Displays the results of Transport test. This result appears if 'Transport' check box is selected in the Test Setup screen.

Pattern

Allows to change the [payload pattern](#). **Cross pattern** check box is the same as **Cross pattern at successive frames** of Payload pattern setting.

Pattern Error insertion This provides the same Error insertion as *Stimuli setup options* in [Application Toolbar](#).

Insertion

If selecting **Manual**, error(s) are inserted when you touch the **Alarm/Error Insert** icon () button.

Set **Off** to stop the error insertion.

Burst length

If 'Insertion' is set to **Manual**, touch the button and set the number of errors to insert.

6.2.3.2 IEEE1588v2 Log

Touching the **IEEE1588v2 Log** button in the navigation area will display the screen shown below.

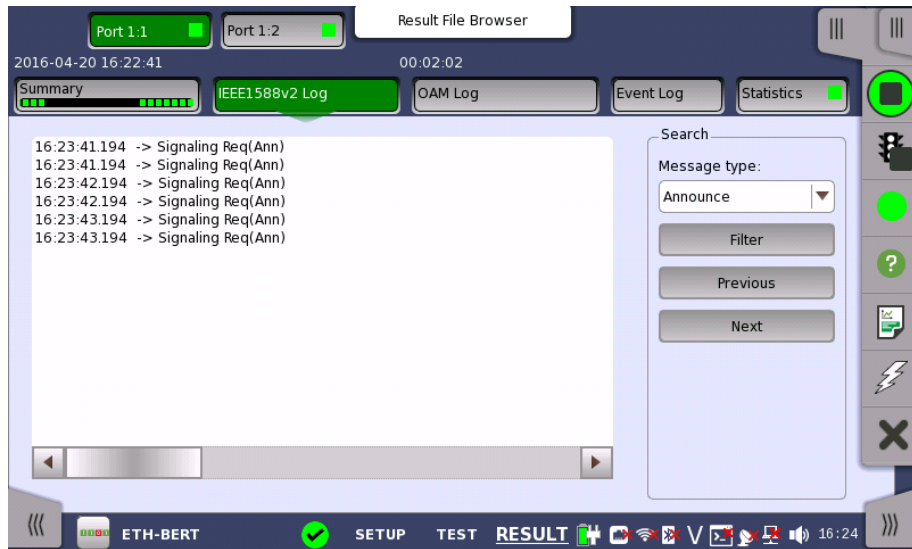

This screen presents an IEEE1588v2 Log of the test results. You can search the messages by specifying the type.

Search

Message type

Select the message type from below.

- Announce
- DelayReq
- DelayResp
- FollowUp
- Management
- PDelayReq
- PDelayResp
- PDelayRespFollowUp
- Signaling
- Sync

Select the search method.

- Filter
- Previous
- Next

6.2.3.3 OAM Log

Touching the **OAM Log** button in the navigation area will display the screen shown below.

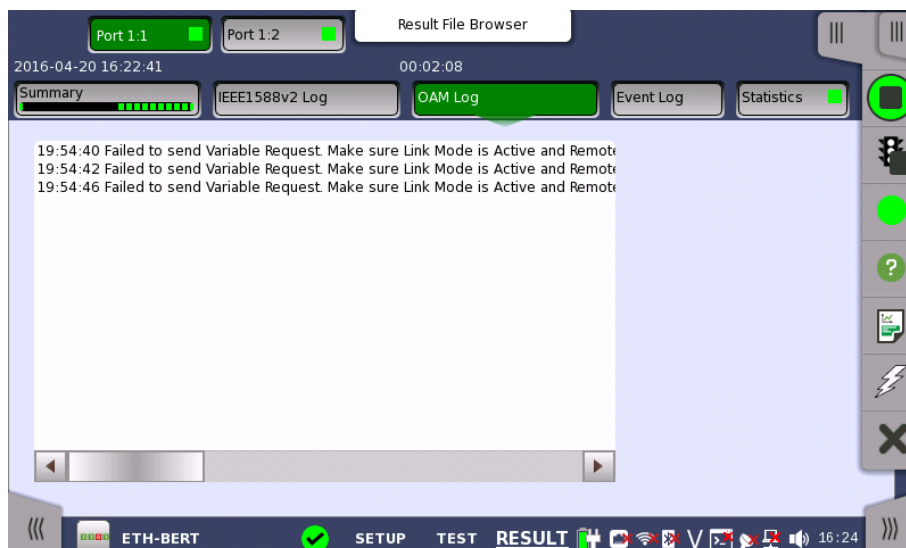

This screen presents an OAM Log of the test results. Note that the layout of the dialog box depends on the currently selected OAM protocol.

6.2.3.4 Event Log

Touching the **Event Log** button in the navigation area displays the screen providing the event log data. Refer to [Event Log](#) of SDH/SONET/PDH/DSn BERT application.

6.2.3.5 Statistics

Touching the **Statistics** button in the navigation area displays the screen shown below.

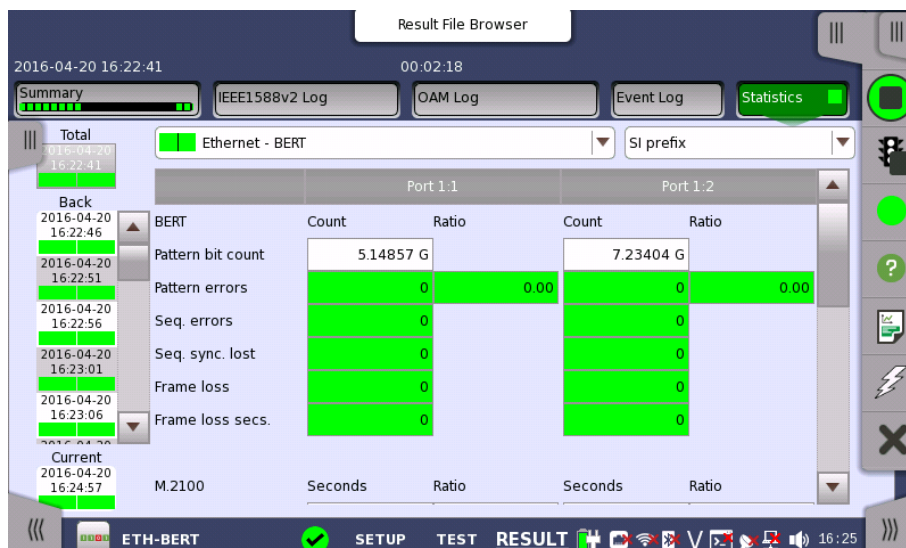

This screen presents a detailed analysis of the test results. You can choose to view either the total results from measurement start or the results of a specific interval during the test. You can also zoom in on a specific result item. The results can be displayed either in table (list) form or as a graph.

Selecting which results to view

Selecting the interval time

Touch the **Total** button to switch the total values measured in all interval times. The start time of measurement is displayed on the button.

Touching the button in left side **Back** field shows the measured values in the interval time. The end time of the interval is displayed on the button.

Current button is displayed at left bottom when the measurement is running. Touching the **Current** button shows the measured values in the current interval time. The start time of the current interval is displayed on the button.

The slide-out panel on the left-hand side of the screen contains the following functions:

- Only show intervals that contains errors
- Time format

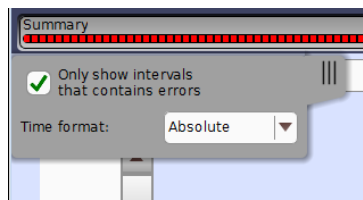

*If you have stopped measurement during the interval time, the measurement results of the current interval are discarded. The log of the current interval is not displayed in **Back** field.*

In this case, result data are re-calculated excluding the data of the current interval when the measurement is stopped. This causes that "Count" and "Ratio" displayed after the measurement will be different from that of during measurement.

The sum of interval time (multiplied interval time by the number of back logs) may not match the differential time between displayed time at left top and right top after the measurement.

Selecting type of results

Open the middle drop-down menu in the top row of buttons to select which results you want to display on the screen.

- OTN - Alarms/Errors
- OTN - Performance
- BERT
- Performance
- Frame
- Burst
- Size Distribution
- Transmit
- Latency
- Jitter
- WAN Alarms/Errors
- WAN G.826
- WAN G.826+G.829
- WAN M.2101.1(M.2100)
- SyncE
- IEEE 1588v2
- PCS
- 802.3ah
- 802.1ag/Y.1731
- FEC
- Conditions

OTN options appear if the Ethernet signal is carried by OTN.

Studying a specific result

Touch a specific cell in a result table to zoom in on the corresponding result item. The **Count** and **Ratio** fields are displayed on a **Zoom** tab page. A **Time vs. Statistics** tab page is also available. Use the **Back** button or touch the zoom filed to return to the statistics screen.



Selecting how results are displayed

Selecting notation

Select the required notation for the results from the notation drop-down menu.

- **Unformatted** - e.g. 71892
- **SI prefix** - e.g. 71.892 k (k means "kilo")
- **Engineering** - e.g. 71.892E3
- **Scientific** - e.g. 7.1892E4

Bits and bytes conversion

The name of the item measured in bits is available as a button. You can convert the unit from Bits to Bytes, by touching the button.

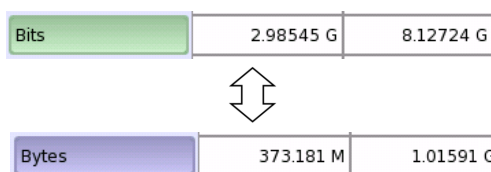

Save results to files

The **CSV Export** button appears when the measurement isn't running. Touch the button, and you can select item(s) you want to export to a CSV file during measurement. The button is not displayed while the measurement is running or when Ethernet is over the OTN layer.

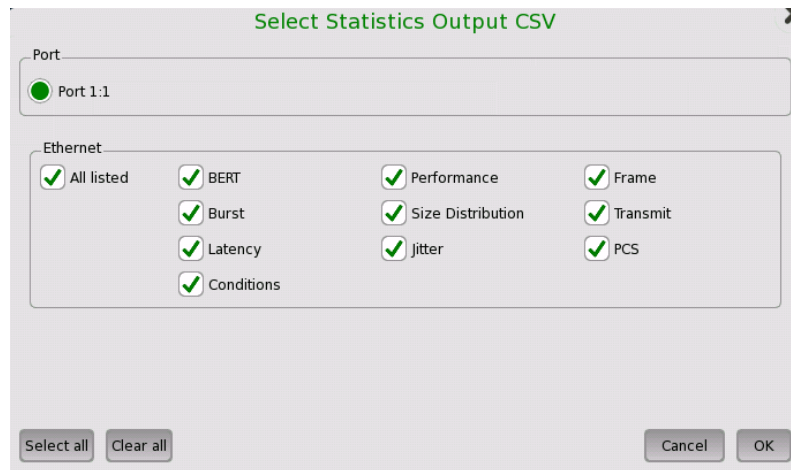

Touch **OK**, and enter the filename.

Results

The result items varies depending on the configuration in Ports Setup screen.

OTN Alarms/Errors	Refer to Results in "OTN Application"
OTN Performance	Refer to Results in "OTN Application"
BERT Results	BERT Service disruption M.2100 Throughpu
Performance Results	Frequency* Utilization Throughpu Frame rate
Frame Results	Alarms Good Frames Errored Frames Layer3 Error Other Frames Last Received Frame diff.
Burst Results	Frames Burst Size
Size Distribution Results	Total Frames Size Dist. Frame Size
Transmit Results	Traffic
Latency Results	Latency(ns) (Latency is displayed in the range of 0 to 20 seconds. In case the measured value is out of this range, N/A is displayed.)
Jitter Results	Jitter(ns)
WAN Alarms/Errors	Alarms Errors
WAN G.826 Results	MUX SPE

WAN G.826+G.829	MUX
Results	SPE
WAN M.2101.1(M.2100)	MUX
Results	SPE
SyncE Results	SSM Statistics Alarms Rx SSM QL
IEEE 1588v2 Results	Offset Stat Offset Variance Mean Path Delay Path delay variation (PDV) Message Stat Signalling Clock Status Stat. GPS - Wall clock
PCS Results	PCS 10G PCS 40G/100G Alignment marker Lane Skew
802.3ah Results	
802.1ag/Y.1731 Results	
FEC Results	LOFA Corr.CW, Uncorr. CW Symbol errors
Conditions	Ext ref. 10MHz Ext. ref. 1PPS GPS

*: Frequency results appear only when no OTN layer.

For the parameters of the following WAN performance measurements, refer to "SDH/SONET Performance Measurement Items" in SDH/SONET/PDH/DSn Applications.

Note that the same results are displayed because Pass/Fail judgement is not performed.

SPE stands for Synchronous Payload Envelope.

- WAN G.826
- WAN G.826+G.829
- WAN M.2101.1(M.2100)

M.2100 Performance Measurement Items

This paragraph describes the performance result items. Measurement time definitions are as below.

S_{Total}

Total measurement time. This is the total time of the measurement excluding the time of power failure.

S_{Avail}

Available time of measurement. Calculated from the following formula:

$$S_{Avail} = S_{Total} - S_{Unavail}$$

$S_{Unavail}$

Unavailable time of measurement. Refer to UAT definition.

M.2100 Performance Parameters

Items	Definition
ES	Errored Second Within S_{Avail} , the number of seconds during which one or more pattern errors occurred.
SES	Severely Errored Second Within S_{Avail} , the number of seconds during which any of the following is detected. <ul style="list-style-type: none"> • 10^{-3} or more pattern errors • LOF • LOS
ALS	Alarm Second Within S_{Avail} , the number of seconds during which any of the following is detected. <ul style="list-style-type: none"> • Link is not established. • Remote Fault • LOF • Errored Frame Count
UAT	Unavailable Time When SES or ALS continues for ten seconds, UAT starts from the beginning of the time. When items other than SES continues for ten seconds, UAT ends at one second before the time. Refer to the figure of Example of Unavailable Time Detection . First, the time (when determining the start of UAT) is not counted as UAT, and then if determined, the UAT is recounted. First, the time (when determining the end of UAT) is counted as UAT, and then if determined, the UAT is recounted. In a word, the values of UAT may be reduced later. The same is applied to other items.
AVT	Available Time The available time of the measurement $S_{Avail} = S_{Total} - S_{Unavail}$
EFS	Error Free Second Within S_{Avail} , the number of seconds during which no errors occurred.

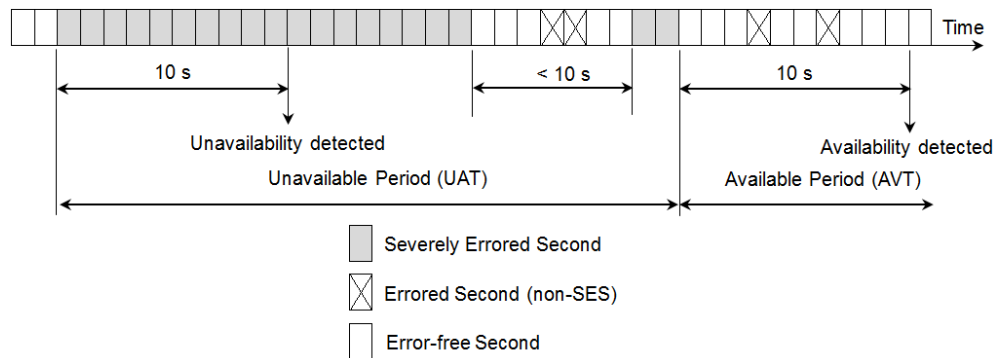

Example of Unavailable Time Detection

About Sequence Error and Sequence Sync Loss

Sequence Error and Sequence Sync Loss are measured as following:

Ethernet frames sent by Network Master include special bytes that indicates sequence number. When receiving this Ethernet frames, Network master sets the sequence number of next incoming Ethernet frame.

Network Master checks sequence numbers in every four straight incoming frames. When the sequence number does not match the expected value, a Sequence Error or a Sequence Sync Loss will occur.

- Sequence Error: When one frame arrived after next sequence number frame.

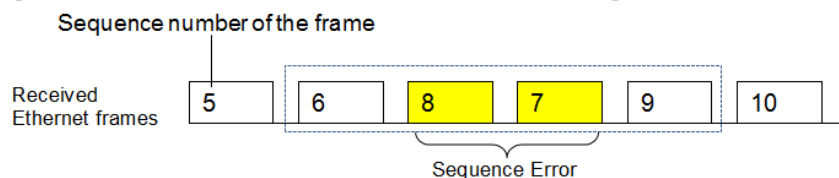

- Sequence Sync Loss: Other case of Sequence Error. For example, when one or more sequence number were lost.

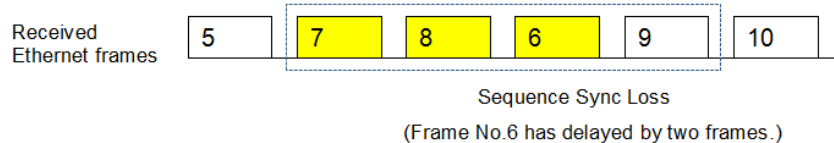
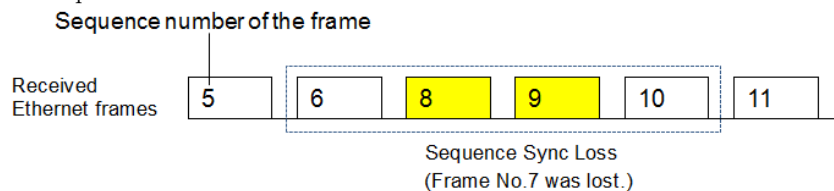

6.3 Cable



The Ethernet Cable Test uses Time Domain Reflectometry (TDR) to validate and detect open and short circuited CAT5/CAT5E cables. This test is convenient for installation and troubleshooting of cables.

Time Domain Reflectometry Principle

The TDR method can be used for control of electrical cables. The TDR transmits a short pulse which will be fully absorbed if the cable is perfectly terminated. In case of open or short circuited cables, the pulse will be reflected.

- An open circuited cable will result in an *increase* of impedance.
- A short circuited cable will result in a *decrease* of impedance.

These conditions will give a pulse reflection in an either positive or negative mirrored pulse. If the time is measured and the speed of the signal in the cable is known, a distance to the problem can be estimated.

The magnitude of the reflection (called the *reflective coefficient P*) can be found from a formula involving the impedance to the load (Z_t) and the resistance in the media (Z_0):

$$P = (Z_t - Z_0) \text{ over } (Z_t + Z_0).$$

$P = 0$ indicates no reflection. $+1$ indicates an open circuit, and -1 indicates a short circuit.

Wiring of Ethernet Cables

A CAT5/CAT5E cable consists of 4 twisted pairs which typically are terminated in a RJ45 connector.

CAT5

Defined in *ANSI/TIA/EIA-568-A*. The color code referring to this standard is called **T568A**.

CAT5E

Defined in *TIA/EIA-568-B*. The color code referring to this standard is called **T568B**.

6.3.1 Test Setup

When you go to the test setup of the Ethernet Cable Test, the following screen is displayed.

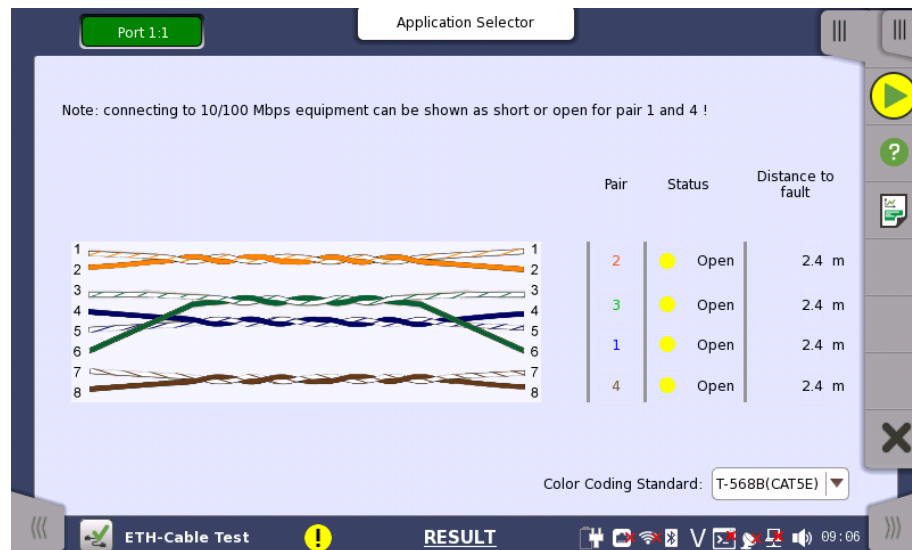

This screen allows you to control and monitor an [Ethernet Cable Test](#).

Test setup controls

Color Coding Standard

Allows you to select the color coding used for the graphical representation of the cables. In the drop-down menu, you can choose between **T-568A (CAT5)** and **T-568B (CAT5E)**.

Test monitoring information

Pair

Lists the individual cable pairs in relation to the pin number and color coding.

Status

Shows the status of the wires inside the cable. The Lamp indicator will be *green* if there is no problem and *red* if there is a problem.

- **OK** indicates a fully functional cable.
- **Short** indicates a short circuited cable.
- **Open** indicates an open circuited cable.

Distance to fault

In case of cable troubles (i.e. an open or a short circuit) the distance to the problem will be indicated approximately in this field.

Detectable distance to the fault is up to 100 m.

6.4 Channel Statistics



The Channel Statistics test separates incoming frames into channels based on a number of defining characteristics (*Definitions*) and shows information about each channel (*Statistics*). The test is mostly used for in-service monitoring, where it provides data for detailed analysis of the traffic types present in the network.

6.4.1 Ports Setup and Status

The first step in running an application is to set up the port interfaces. This is done on the **Ports Setup** screen, which also provides port status information.

The setup options and status information related to the Ethernet interface are described in a separate section:

- [Ethernet Setup and Status](#)

6.4.2 Test Setup

6.4.2.1 Control

Refer to "[Control](#)" in "BERT" section for the operation.

6.4.2.2 Generator

Refer to "[Generator](#)" in "BERT" section for the operation.

6.4.2.3 Stream - profile

Refer to "[Streams - profile](#)" in "Mon/Gen" section for the operation.

6.4.2.4 Stream - Meas.

Refer to "[Streams - Meas.](#)" in "Mon/Gen" section for the operation.

6.4.2.5 Definitions

Touching the **Definitions** button in the navigation area displays the following screen.

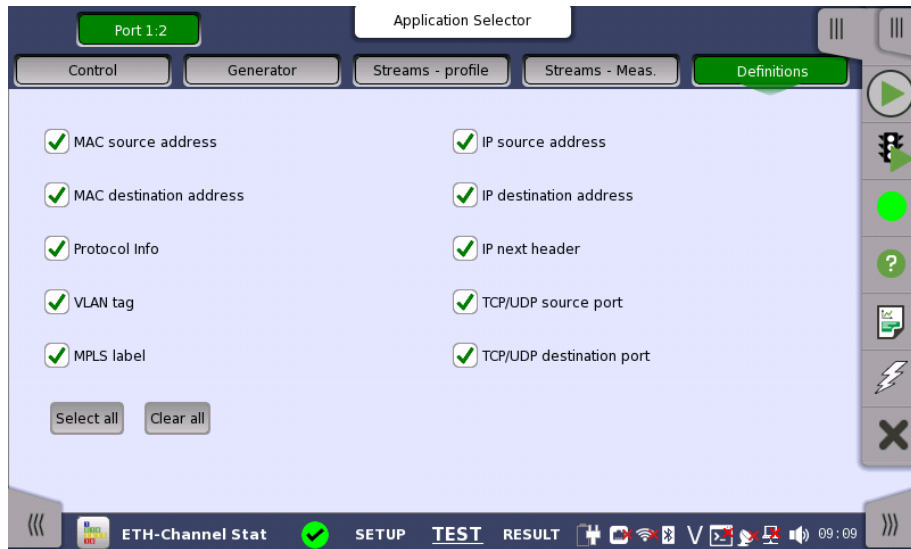

This screen is where you specify which frame characteristics are considered when performing the channel separation (i.e. which frame characteristics are active during the test). The maximum number of channels is 231.

6.4.3 Test Results

6.4.3.1 Summary

Touching the **Summary** button in the navigation area will display the screen shown below.

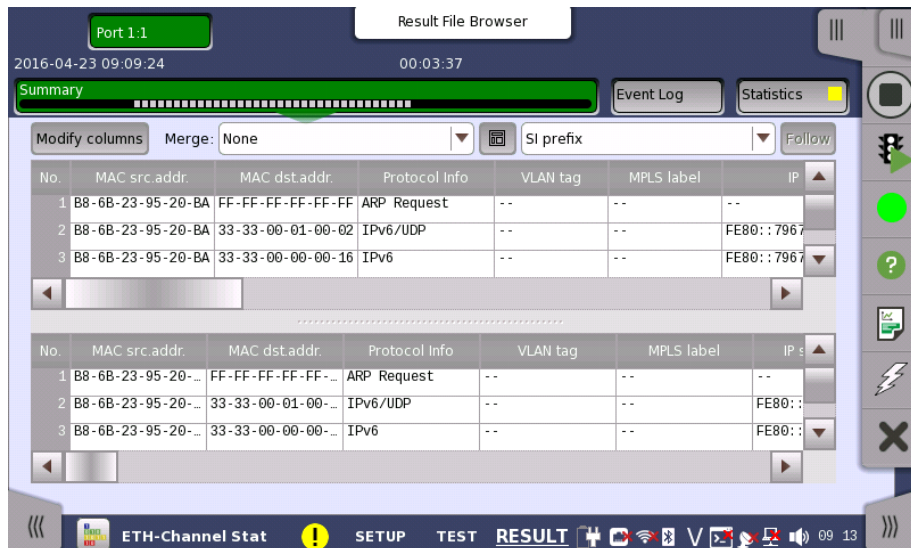

This screen presents the results of the Channel Statistics test. The screen contains two lists, one which lists the created channels and another which shows the results for each channel. Each channel is shown as a row in the two lists.

The lists can be shown either above each other (with the channels list on top) or beside each other (with the channels list to the left). Use the  button in the top row of fields and buttons to switch between the two layouts.

Merging channels

To get a better overview of a certain aspect of the received traffic, you can combine channels using the *Merge* functionality.

Open the **Merge** drop-down menu to combine all channels where one specific definition value (e.g. the source MAC address) is identical. The drop-down menu contains all currently active definitions.

When the test results are shown in merged mode, definitions that are not uniquely defined will be hidden, so that only the merge criterion, channel number, and protocol information will be visible. The protocol information field, which shows which protocols are detected in a channel, will in merged mode show all protocols present in the frames contained in the merged channel.

Unlike the setup of active definitions, the merge setting works on already collected channels - that is, it does not affect how the system separates channels, and it will work on both running, stopped and loaded tests.

Selecting notation

Select the required notation for the results from the notation drop-down menu.

- **Unformatted** - e.g. 71892
- **SI prefix** - e.g. 71.892 k (k means "kilo")
- **Engineering** - e.g. 71.892E3
- **Scientific** - e.g. 7.1892E4

Modifying columns

To select which columns are shown in the two lists, touch the **Modify columns** button. This will launch the **Modify shown columns** dialog box.

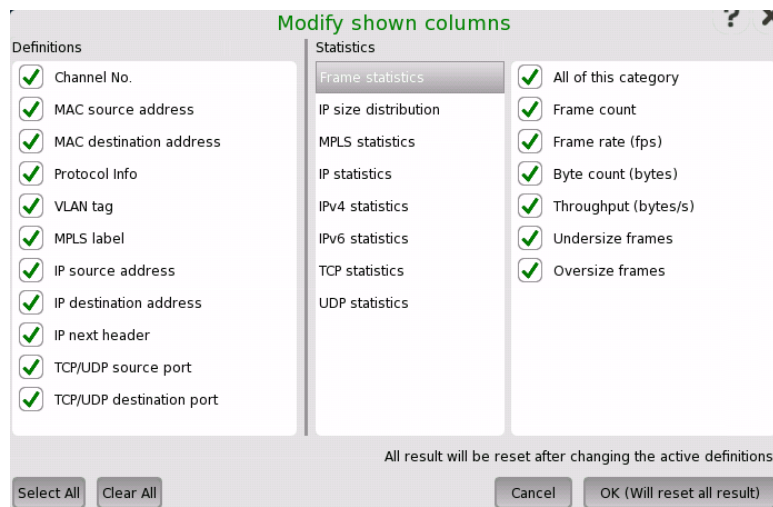

Definitions

The selected check boxes correspond to the columns currently shown in the channels list on the **Summary** screen.

Statistics

The selected check boxes correspond to the columns currently shown in the results list on the **Summary** screen. Note that the check boxes are placed under categories.

- **Frame statistics**
- **IP size distribution**
- **MPLS statistics**
- **IP statistics**
- **IPv4 statistics**
- **IPv6 statistics**

- TCP statistics
- UDP statistics

Select/Clear all

To select all check boxes in the dialog box, touch the **Select All** button.

To clear all check boxes in the dialog box, touch the **Clear All** button.

6.4.3.2 IEEE1588v2 Log

If **Ext. log** is selected in IEEE1588v2 screen of Ethernet Frame Setup, the **IEEE1588v2 Log** button appears in the navigation area. Refer to [IEEE1588v2 Log](#) in "BERT" for the operation.

6.4.3.3 Event Log

Touching the **Event Log** button in the navigation area displays the screen providing the event log data. Refer to [Event Log](#) of SDH/SONET/PDH/DSn BERT application.

6.4.3.4 Statistics

Touching the **Statistics** button in the navigation area displays the screen providing the statistics data. Refer to [Statistics](#) of Mon/Gen for the operation.



The frame count result in the Statistics screen may not match to the result in the Summary screen, because the measurement start time and the stop time are different between Summary screen and Statistics screen.

6.5 Mon/Gen



Ethernet Monitor/Generate is typically used for out-of-service and performance testing. It is possible to perform a passive, non-intrusive monitoring or at the same time transmit test data, which can be reflected for further evaluation and testing of the network.

6.5.1 Ports Setup and Status

The first step in running an application is to set up the port interfaces. This is done on the **Ports Setup** screen, which also provides port status information.

The setup options and status information related to the Ethernet interface are described in a separate section:

- [Ethernet Setup and Status](#)

For applications also including an OTN interface, you can find a description of the setup options and status information for OTN in the following section:

- [OTN Setup and Status](#)

Please refer to the sections relevant for your current port setup requirements.

6.5.2 Test Setup

Copy frame content to other stream(s)

This feature allows you to copy the frame content of the stream that you are currently configuring to all streams in another port or to a single stream.

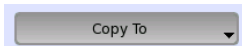

Touching the **Copy To** button opens a drop-down menu from which you can select the relevant port and **All** or a specific stream.

6.5.2.1 Control

Refer to "[Control](#)" in BERT Test Setup subsection for the operation.

6.5.2.2 Generator

Refer to "[Generator](#)" in BERT Test Setup subsection for the operation.

6.5.2.3 Streams - Profile

Touching the **Streams - Profile** button in the navigation area displays the following screen.

The **Follow** button appears when the Port 2 settings can follow Port 1.

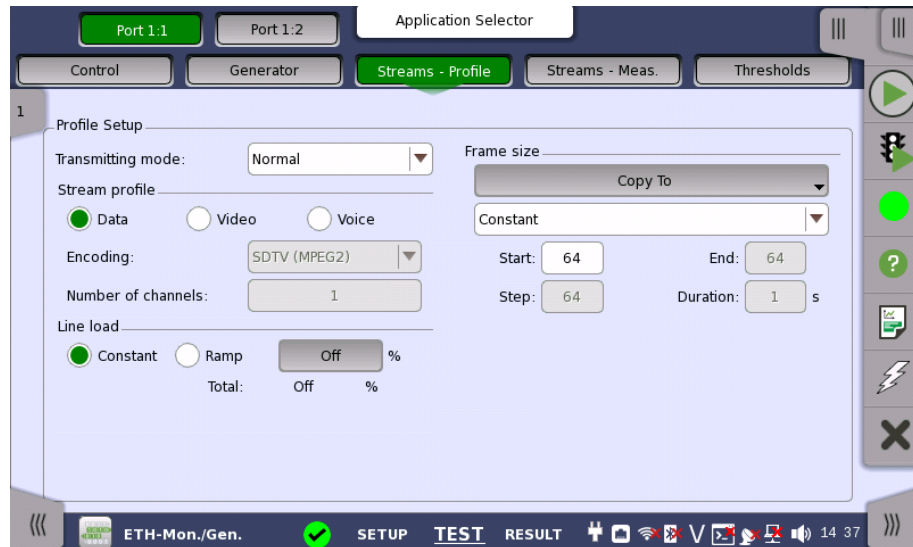

This screen contains the parameters for specifying a profile and pattern for each stream and for specifying which measurements are made.

Stream selection

Use the slide-out panel on the left-hand side of the screen to select the relevant stream. Enable the stream by touching the button on the slide-out panel.

Transmission mode

- **Normal:** Does not generate the bursts. The normal Ethernet frames are sent.
- **Burst:** Generate the bursts.

Stream X profile

Allows you to specify and configure a profile type for the currently selected stream. Using the radio buttons, you can select the stream profile as either **Data**, **Video** or **Voice**.

Encoding

Open the drop-down menu to select the relevant encoding type. The available values depend on the selected profile type.

Number of channels

Specify the number of channels.

Line load

When Profile type is set to **Data**, you can select the line load profile as either **Constant** or **Ramp**. If you select **Ramp**, you can touch the adjacent button to display the **Ramp Line Load Setup** dialog box.

When Profile type is set to **Video** or **Voice**, the line load calculated from Encoding and Number of channels is displayed.

The sum of the line load of each stream is displayed under the button.

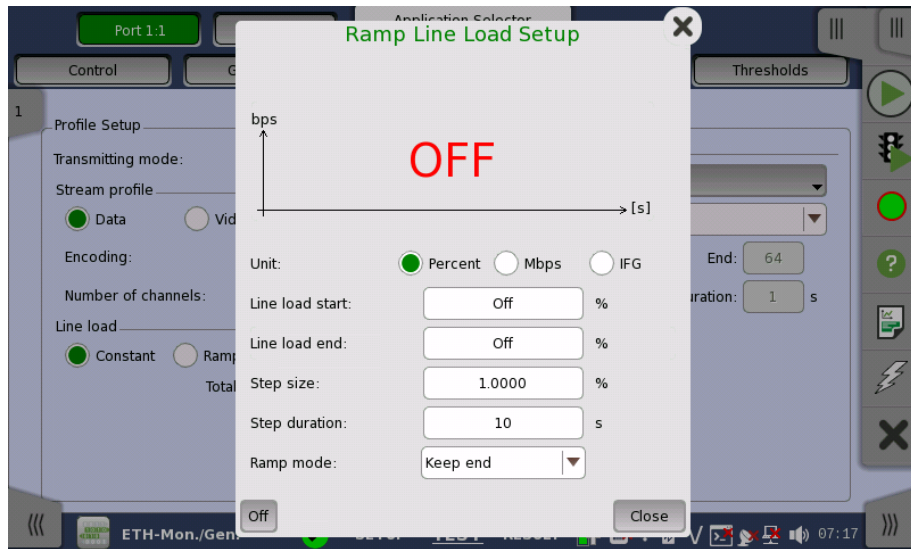

The line load unit can be specified from **Percent**, and **Mbps**. Touching **Off** at left-bottom stops sending the stream.

The dialog box contains the following settings:

Line load start

The line load at which the ramp will start.

Line load end

The line load at which the ramp will end. (This is the value shown on the line load button.)

Step size

The step size from start to end.

Step duration

The duration of each step.

Ramp mode

How the ramp should continue. 3 modes are available:

- **Keep end:** The specified end line load is maintained after the ramp is ended.
- **Repeat ramp:** The ramp is repeated.
- **Invert ramp:** The ramp is inverted.

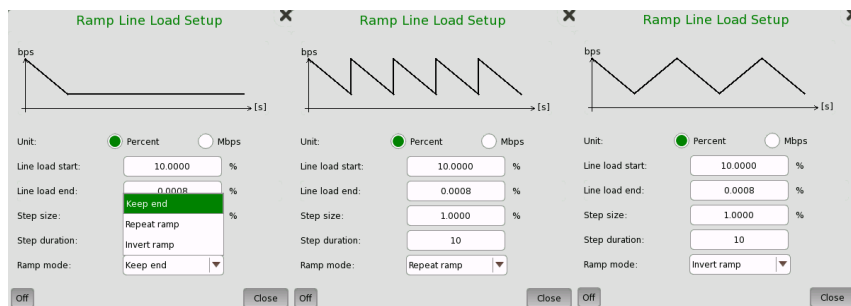

Frame size

When Profile is set to **Data**, three setups are available:

Constant

Uses the fixed frame size specified by the **Start** value for the duration of the test. The following figure shows an example of frame sizes when **Constant** is selected.

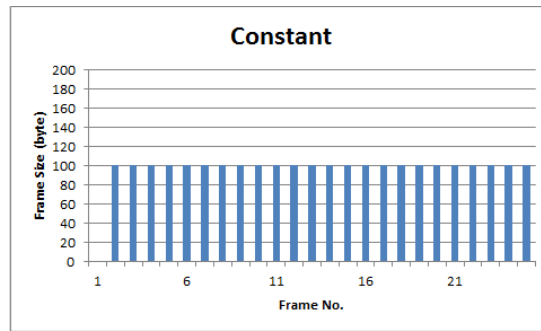

Stepped

Steps the frame size from **Start** to **End** in increments of **Step**. Each frame size is transmitted for the period in seconds specified by **Duration**. The following figure shows an example of frame sizes when **Stepped** is selected.

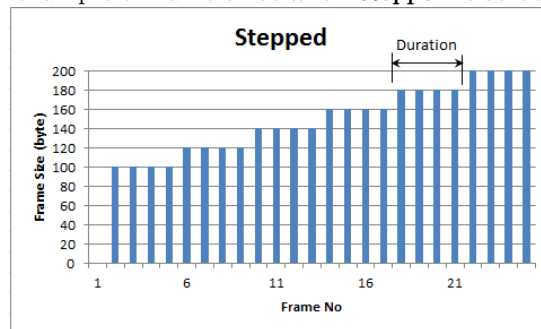

If the traffic duration is set to *Continuous* on the **Generator** screen, the step sequence will be repeated indefinitely. If traffic duration is set to *a number of seconds*, the step sequence will be terminated when the specified total period has elapsed. Similarly for traffic duration set to *a number of frames*, the step sequence will be terminated when the total number of transmitted frames reaches the specified count.

Random

Sends a continuous stream of frames of random sizes, evenly distributed between **Start** and **End**. The following figure shows an example of frame sizes when **Random** is selected.

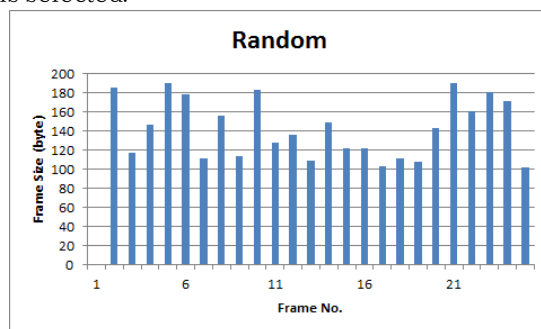

Frame size is protocol headers and payload combined. Frame size does not include preamble and interframe gap.

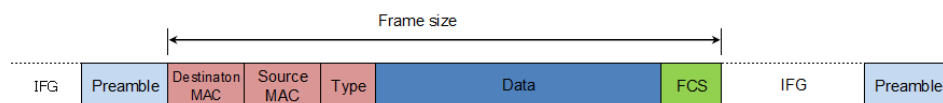

Burst mode

Set the burst generation mode. The normal Ethernet frames are not sent in the burst mode.

- **Off**: stops sending the stream.

- **Const:** generates the bursts that the data length and the gap length are constant.

When **Const** is selected, "Burst" is displayed on multi stream slide.

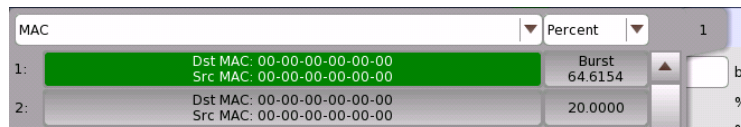

Number of Bursts

Selecting **n-Burst** allows to set the number of the bursts to generate. If sending specified number bursts has finished, sending stream will stop.

Duty

Set the burst data length and the gap length.

Touch the field of **Duty** and **Period** to set the value.

Frame size

Set the frame size used for the burst data length calculation. 20 bytes (preamble and IFG) adding to the value set in this field is used as the one frame size of the burst data length.

6.5.2.4 Streams - Meas.

Touching the **Streams - Meas.** button in the navigation area displays the following screen.

The **Follow** button appears when the Port 2 settings can follow Port 1.

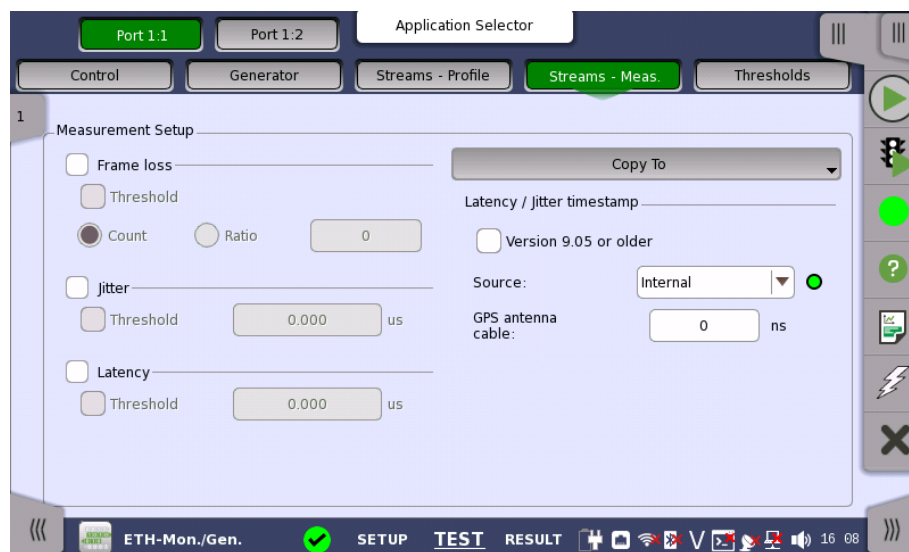

This screen allows you to configure **Frame Loss**, **Jitter**, and **Latency**.

Frame Loss

Select Frame Loss to measure it.

When selecting Threshold and enter the value, Pass/Fail is judged.

If selecting Count, set the frame loss number.

If selecting Ratio, set the frame loss ratio.

Jitter

Select Jitter to measure it.

When selecting Threshold and enter the value, Pass/Fail is judged.

Latency

Select Latency to measure it.

**Latency / Jitter
timestamp**

When selecting Threshold and enter the value, Pass/Fail is judged.

This screen allows you to configure the resolution of **Jitter** and **Latency**.

Version 9.05 or older

When selecting "Version 9.05 or older", the measurement is performed with a resolution of 0.1 μ s which is same as the software version of Version 9.05 or older.

It is not available to perform measurement by using Network Masters which have different resolution setup. If the software version of the Network Master on the opposite side at the facing test is 9.05 or older, select this.

At Ethernet + OTN or WAN measurement, this is automatically selected.

When not selecting "Version 9.05 or older", the measurement can be performed with a resolution of 0.005 μ s depending on "Timestamp source" selection and using a GPS.

Source

Select a timestamp source for measurement. The color of the right-hand indicator shows whether latency and/or jitter can be measured or not.

Green: Latency and/or jitter can be measured.

Red: There is a possibility that the timestamp source signal could not be detected. For the detection status of the timestamp source signal, refer to

[Timestamp source availabilities](#).

Only when MU100011A is installed and **Version 9.05 or older** is NOT selected, **GPS (Ext ref. 10MHz)**, and **1PPS(Ext ref. 10MHz)** can be selected.

When **GPS, 1PPS(Ext ref. 10MHz)**, or **GPS(Ext ref. 10MHz)** is set, the measurement can be performed by using two Network Masters which have made synchronized.

In this case, set the same option to **Source(Ext ref. 10MHz)** of both Network Master.

Round Trip time and One Way Latency can be measured by setting Source in combination show in the table below.

Module Model	Round Trip time	One Way Latency	
	Source	Source	GPS receiver to be used
MU100010A	Internal	GPS	G0325A or MU100090A
MU100011A	Internal	GPS	G0325A
		1PPS(Ext ref. 10MHz)	GPS receiver provided by other than Anritsu MU100090A ^{*1}
		GPS(Ext ref. 10MHz)	MU100090A ^{*2}

*1: When the MU100090A is feeding 1PPS and 10 MHz clock to two MT1000As.

*2: When the MU100090A is feeding 1PPS and 10 MHz clock to one MT1000A.

Internal

This option uses the timestamp generated inside the Network Master.

GPS

This option uses the timestamp generated based on TOD (Time of Day) signal

and 1PPS signal which are provided by the GPS receiver G0325A GPS Receiver or MU100090A can be used. The 10 MHz clock provided by MU100090A is not used for generating the timestamp. One way latency can be measured.

1PPS (Ext ref. 10MHz)

This option uses the timestamp generated based on 1PPS signal and 10 MHz clock which are provided by the GPS receiver. By using 10 MHz clock, the measurement can be performed in higher accuracy than the one when selecting **GPS**.

One way latency can be measured.

Due to using 1PPS signal, the latency of one second or less than can be measured.

This option allows users to use other vendor's GPS other than G0325A and MU100090A. In this case, J1705A AUX Conversion Adaptor is required.

GPS (Ext ref. 10MHz)

This option uses the timestamp generated based on TOD (Time of Day) signal, 1PPS, and 10 MHz clock which are provided by MU100090A. By using 10 MHz clock, the measurement can be performed in higher accuracy than the one when selecting **GPS**.

One way latency can be measured.

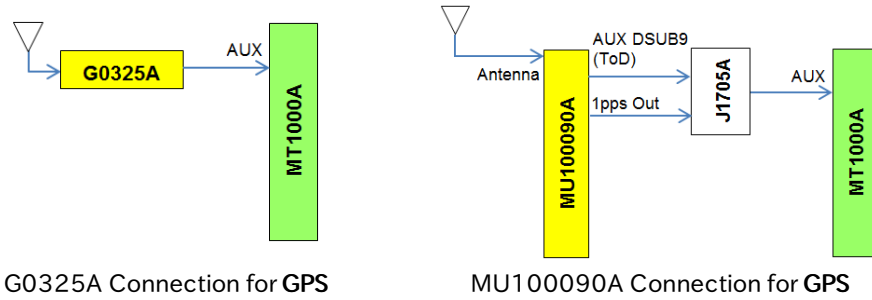

G0325A Connection for GPS

MU100090A Connection for GPS

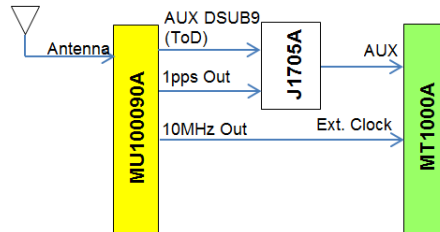

MU100090A Connection for GPS (Ext ref. 10MHz)

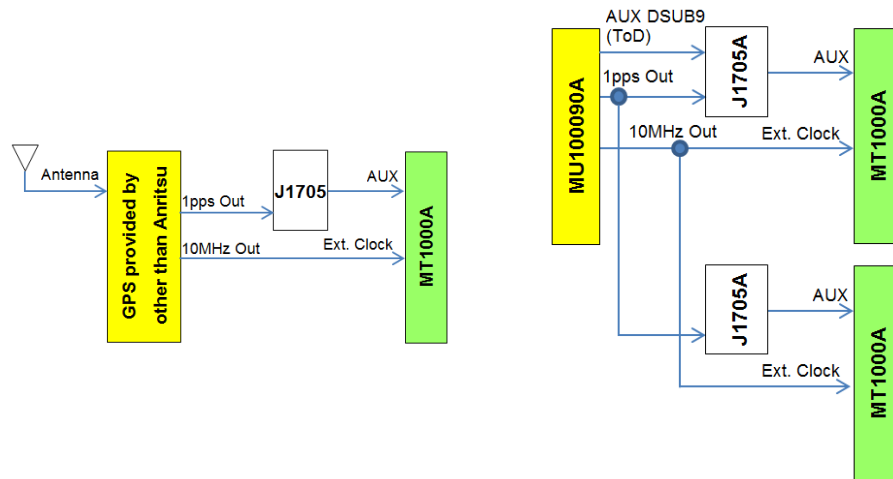

Connection of GPS provided by other than Anritsu for 1PPS(Ext ref. 10MHz)

Connection of MU100090A and Two MT1000As for 1 PPS(Ext ref. 10MHz)

GPS antenna cable

To measure the phase error precisely, set the correction value to GPS cable correction.

When calculating the delay time from the cable length, it is recommendable to use 5 ns/m as the conversion factor.

When using the following GPS provided by Anritsu, set 25 ns.

- G0325A
- MU100090A (When using J1706A GPS antenna of the standard accessory)

6.5.2.5 Thresholds

For **Total Frame Difference** and **Ethernet**, refer to "[Thresholds](#)" in BERT Test Setup subsection for the operation.

6.5.3 Test Results

6.5.3.1 Summary

When you go to the test results of the Ethernet Monitor/Generate application, the following screen is displayed.

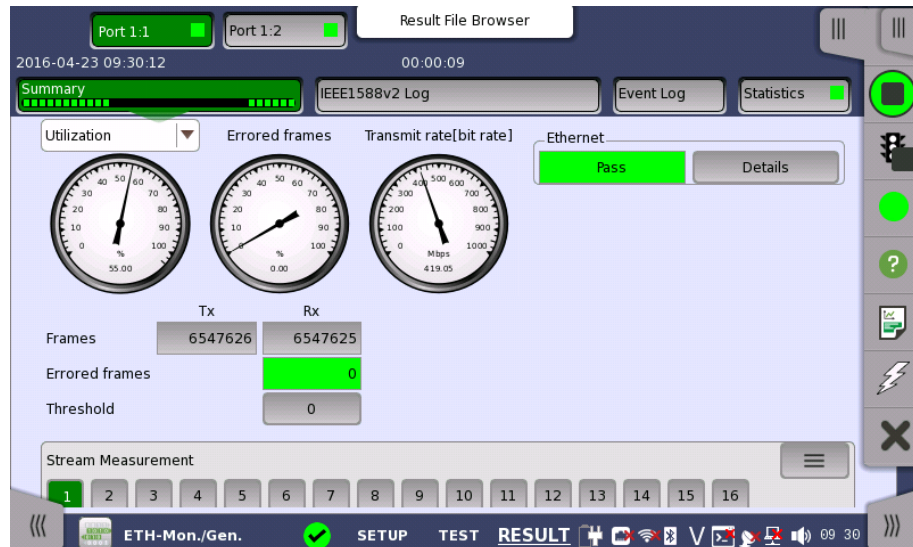

This screen contains a summary of the results of the Ethernet Monitor/Generate test. The information includes such things as number of errored frames and number of exceeded thresholds.

The three dials showing utilization/throughput results, pattern errors and errored frames can be enlarged by touching on them. The black needle points the measured value in the latest period.



To view throughput information, select **Throughput** in the drop-down menu and then expand the dial. Use the drop-down menu above the expanded dial to select the relevant layer.

When **Ethernet** is selected on 'Threshold' of the Test Setup screen, the **Ethernet** information appears in the upper right-hand corner, shows pass/fail status summary. Touching the **Details** button allows you to inspect the individual pass/fail status.



Transport

Displays the results of Transport test. This result appears if 'Transport' check box is selected in the Test Setup screen.

The stream slide-up at the bottom of the screen allows you to configure and inspect the measurements of each individual stream. Display/Hide the slide-up by touching the handle icon. You can set up thresholds for frameloss, latency and jitter for each stream as well as inspect the measurement results.

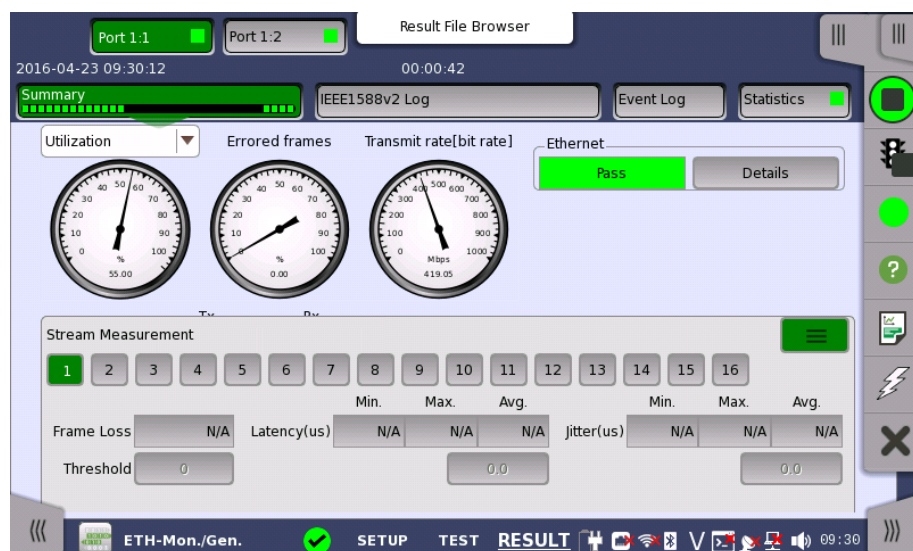

6.5.3.2 IEEE1588v2 Log

If **Ext. log** is selected in IEEE1588v2 screen of Ethernet Frame Setup, the **IEEE1588v2 Log** button appears in the navigation area. Refer to [IEEE1588v2 Log](#) in "BERT" for the operation.

6.5.3.3 OAM Log

The operation of **OAM Log** screen is the same as that of BERT application. Refer to [OAM Log](#) in BERT for the operation.

6.5.3.4 Event Log

Touching the **Event Log** button in the navigation area displays the screen providing the event log data. Refer to [Event Log](#) of SDH/SONET/PDH/DSn BERT application.

6.5.3.5 Statistics

Touching the **Statistics** button in the navigation area displays the screen shown below.

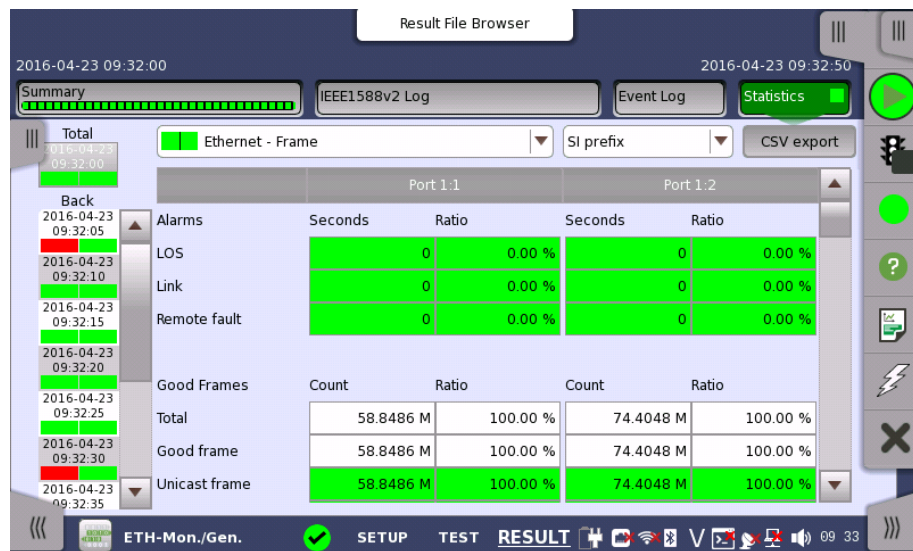

This screen presents a detailed analysis of the test results. You can choose to view either the total results from measurement start or the results of a specific interval during the test. You can also zoom in on a specific result item. The results can be displayed either in table (list) form or as a graph.

Selecting which results to view

Selecting the interval time

Touch the **Total** button to switch the total values measured in all interval times. The start time of measurement is displayed on the button.

Touching the button in left side **Back** field shows the measured values in the interval time. The end time of the interval is displayed on the button.

The **Current** button is displayed at left bottom when the measurement is running. Touching the **Current** button shows the measured values in the current interval time. The start time of the current interval is displayed on the button.

The slide-out panel on the left-hand side of the screen contains the following functions:

- Only show intervals that contains errors
- Time format

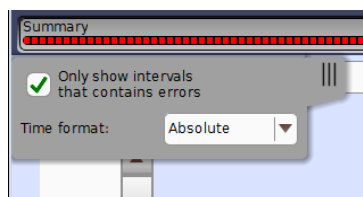

*If you have stopped measurement during the interval time, the measurement results of the current interval are discarded. The log of the current interval is not displayed in **Back** field.*

In this case, result data are re-calculated excluding the data of the current interval when the measurement is stopped. This causes that "Count" and "Ratio" displayed after the measurement will be different from that of during measurement.

The sum of interval time (multiplied interval time by the number of back logs) may not match the differential time between displayed time at left top and right top after the measurement.

Selecting type of results

Open the middle drop-down menu in the top row of buttons to select which results you want to display on the screen.

- Performance
- Frame
- Burst
- Size Distribution
- Transmit
- Multi Stream Transmit
- Multi Stream Throughput
- Multi Stream Frame Loss
- Multi Stream Latency
- Multi Stream Jitter
- SyncE
- IEEE 1588v2
- 802.3ah
- 802.1ag/Y.1731
- FEC
- Conditions

Studying a specific result

Touch a specific cell in a result table to zoom in on the corresponding result item. The **Count** and **Ratio** fields are displayed on a **Zoom** tab page. A **Time vs. Statistics** tab page is also available. Use the **Back** button or touch the zoom filed to return to the statistics screen.

Selecting how results are displayed

Selecting notation

Select the required notation for the results from the notation drop-down menu.

- **Unformatted** - e.g. 71892
- **SI prefix** - e.g. 71.892 k (k means "kilo")
- **Engineering** - e.g. 71.892E3
- **Scientific** - e.g. 7.1892E4

Bits and bytes conversion

The name of the item measured in bits is available as a button. You can convert the unit from Bits to Bytes, by touching the button.

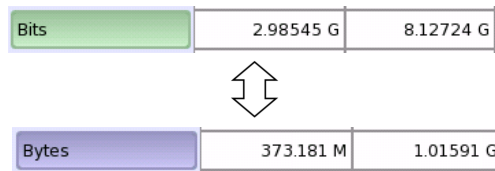

Save results to files

The **CSV Export** button appears when the measurement isn't running. Touch the button, and you can select item(s) you want to export to a CSV file during measurement. The button is not displayed while the measurement is running.

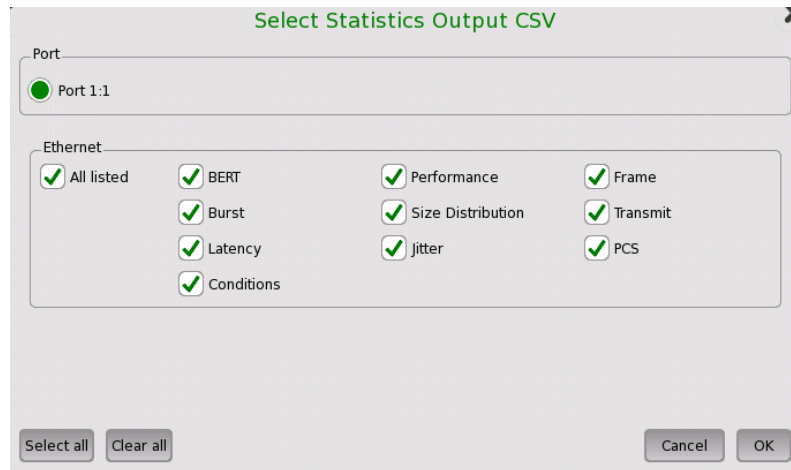

Touch **OK**, and enter the filename.

Results

Results are displayed according to your choice.

Performance

Utilization

Throughput

Frame rate

Frame

Alarms

Good Frames

Errored Frames

Layer3 Error

Other Frames

Last Received

Frame diff.

Bursts

Frames

Burst Size

Size Distribution

Total Frames

Size Dist.

Frame Size

Transmit

Traffic

Multi Stream Transmit

Traffic

Multi Stream Throughput

Throughput

Multi Stream Frame Loss

Frame Loss

Multi Stream Latency

Latency(us)

(Latency is displayed in the range of 0 to 20 seconds. In case the measured value is out of this range, N/A is displayed.)

Multi Stream Jitter

Jitter(us)

SyncE

SSM Statistics

Alarms

Rx SSM QL

IEEE 1588v2

Offset Stat.

Offset Variance

Mean Path Delay

Path delay variation (PDV)

Message Stat

Signalling

Clock Status Stat.

PCS

PCS 10G/25G

PCS 40G/100G

Alignment marker

Lane Skew

802.3ah

802.1ag/Y.1731

FEC

LOFA

Corr.CW, Uncorr. CW

Symbol errors

Conditions

Ext ref. 10MHz

Ext. ref. 1PPS

GPS

6.6 Pass Through



Ethernet Pass Through enables non-intrusive in-service monitoring for both fast troubleshooting and detailed analysis of the live traffic on a network. All traffic received on a port is forwarded on the other port and vice versa. Traffic between the two network DUT elements is monitored as illustrated below.

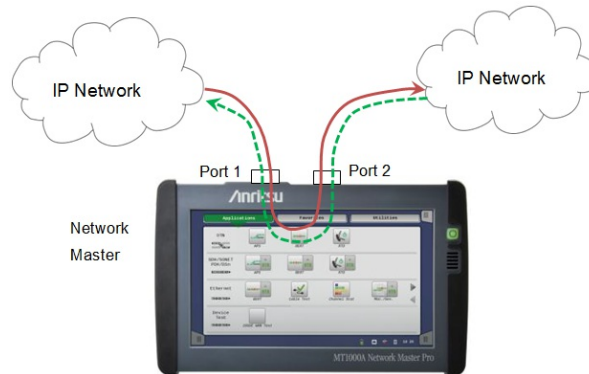

6.6.1 Ports Setup and Status

The first step in running an application is to set up the port interfaces. This is done on the **Ports Setup** screen, which also provides port status information.

The setup options and status information related to the Ethernet interface are described in a separate section:

- [Ethernet Setup and Status](#)

6.6.2 Test Setup

6.6.2.1 Control

Refer to "[Control](#)" in BERT Test Setup subsection for the operation.

6.6.2.2 Thresholds

Touching the **Thresholds** button in the navigation area displays the following screen.

The **Follow** button appears when the Port 2 settings can follow Port 1.

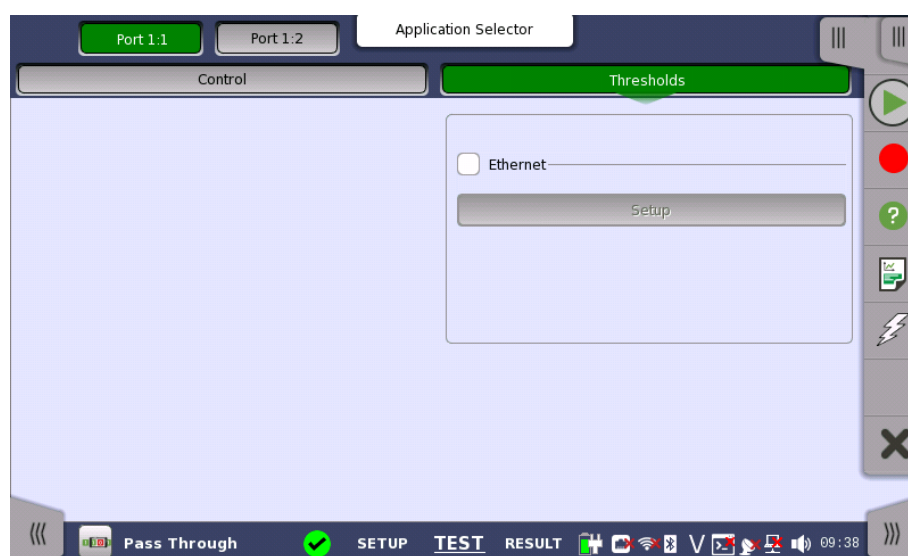

Ethernet

When you select the check box, you can enable various thresholds. Touch the **Setup** button to display the **Ethernet threshold setup** dialog box.

6.6.3 Test Results

6.6.3.1 Summary

When you go to the test results of the Ethernet Pass Through application, the following screen is displayed.

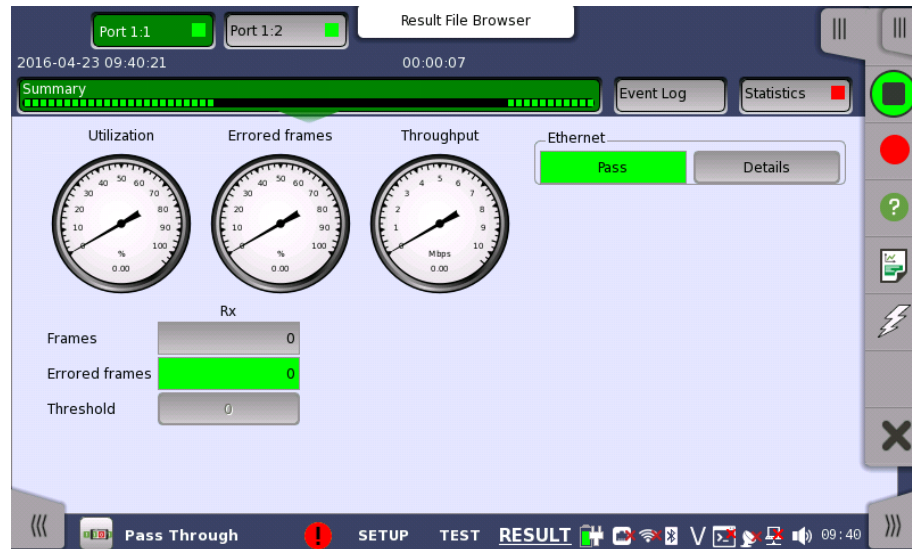

This screen contains a summary of the results of the Ethernet Pass Through test. The information includes such things as number of errored frames and number of exceeded thresholds.

The three dials showing utilization/throughput results, pattern errors and errored frames can be enlarged by touching on them. The black needle points the measured value in the latest period.

When **Ethernet** is selected on 'Threshold' of Test Setup screen, the **Ethernet** information appears in the upper right-hand corner, shows pass/fail status summary. Touching the **Details** button allows you to inspect the individual pass/fail status. Refer to [Summary](#) in BERT section.

6.6.3.2 Event Log

Touching the **Event Log** button in the navigation area displays the screen providing the event log data. Refer to [Event Log](#) of SDH/SONET/PDH/DSn BERT application.

6.6.3.3 Statistics

Touching the **Statistics** button in the navigation area displays the screen providing the statistics data. Refer to [Statistics](#) of BERT for the operation.

6.7 Ping



The Ethernet Ping test is a quick and easy way for testing, troubleshooting and verification of connectivity and latency. Packets are sent from the source address to the destination address and back again - allowing the user to determine whether traffic is possible.

6.7.1 Ports Setup and Status

The first step in running an application is to set up the port interfaces. This is done on the **Ports Setup** screen, which also provides port status information.

The setup options and status information related to the Ethernet interface are described in a separate section:

- [Ethernet Setup and Status](#)

6.7.2 Test Setup

When you go to the test setup of the Ethernet Ping application, the following screen is displayed.

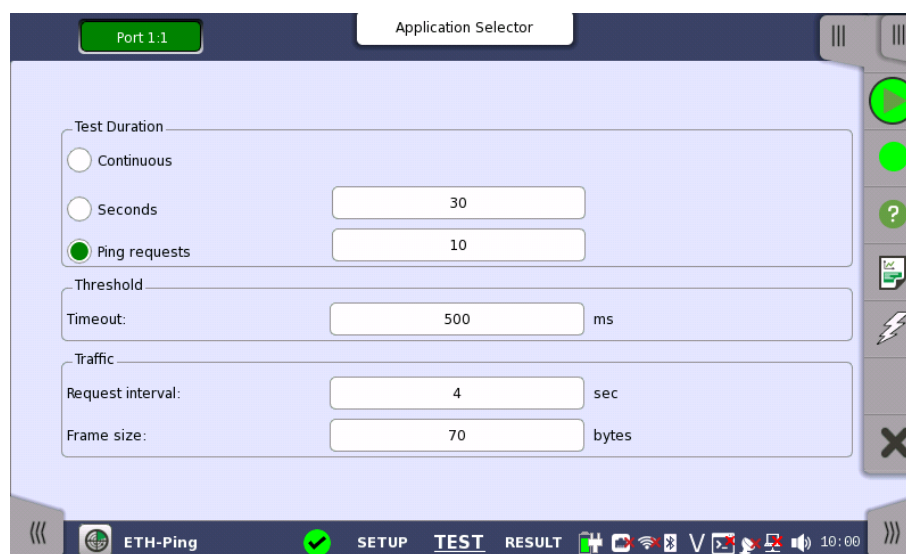

This screen allows you to configure the Ping test conditions for the currently selected port.

Test Duration

Allows you to define the test duration in one of three ways:

- **Continuous** - Used when a *persistent Ping test* is needed.
- **Seconds** - Used to define the test duration in *seconds*.
- **Ping requests** - Used to define the test duration in *number of ping requests*.

Threshold

Allows you to specify the **Timeout** threshold value in milliseconds (ms).

Traffic

Request interval

Allows you to specify the interval between frames in seconds.

Frame size

Allows you to specify the frame size in bytes.



Frame size is protocol header and payload combined. Frame size does not include preamble and interframe gap.

6.7.3 Test Results

The results of an Ethernet Ping test relate to a specific port and consist of the Round Trip Times of the ping requests. The data is shown in both list-form and in a graphical presentation.

Graphical presentation

The graphical presentation consists of a bar diagram of the Round Trip Times and of a pie chart showing the percentage distribution of echo replies and timeouts.

6.7.3.1 Summary

When you go to the test results of the Ethernet Ping test, the following screen is displayed.

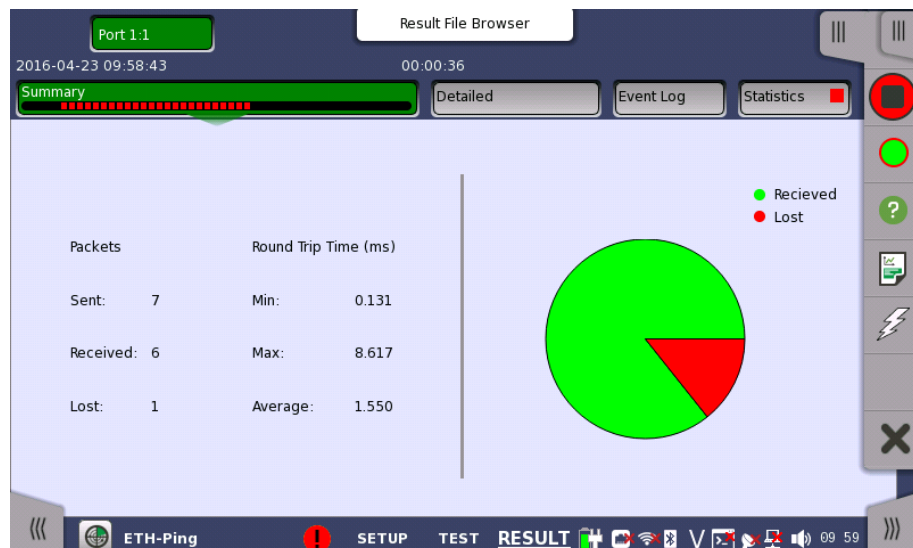

This screen presents a summary of the results of an Ethernet Ping test. The results relate to a specific port and consist of information about sent/received/lost packages and the minimum/maximum/average Round Trip Time.

Graphical presentation

The graphical presentation consists of a pie chart showing the percentage distribution of received/lost packages.

6.7.3.2 IEEE1588v2 Log

If **Ext. log** is selected in IEEE1588v2 screen of Ethernet Frame Setup, the **IEEE1588v2 Log** button appears in the navigation area. Refer to [IEEE1588v2 Log](#) in "BERT" for the operation.

6.7.3.3 Detailed

Touching the **Detailed** button in the navigation area will display the following screen.

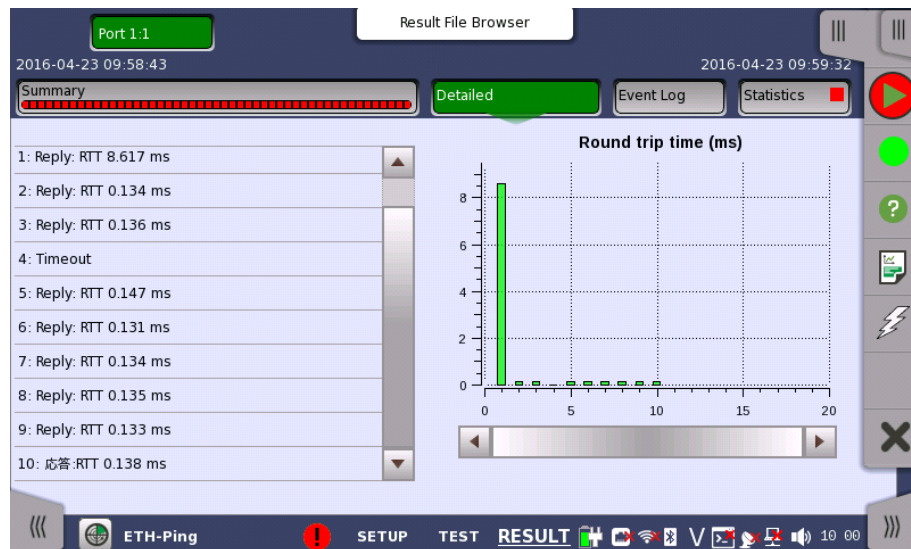

This screen presents the detailed results of an Ethernet Ping test. The results relate to a specific port and consist of the Round Trip Times of the individual Ping requests. The data is shown in both list-form and in a graphical representation.

Graphical presentation

The graphical presentation consists of a bar diagram of the round trip times.

6.7.3.4 Event Log

Touching the **Event Log** button in the navigation area displays the screen providing the event log data. Refer to [Event Log](#) of SDH/SONET/PDH/DSn BERT application.

6.7.3.5 Statistics

Touching the **Statistics** button in the navigation area displays the screen providing the statistics data. Refer to [Statistics](#) of BERT for the operation.

6.8 Reflector



In *Ethernet Reflector* mode the Network Master loops incoming traffic on a port swapping MAC and/or IP addresses.

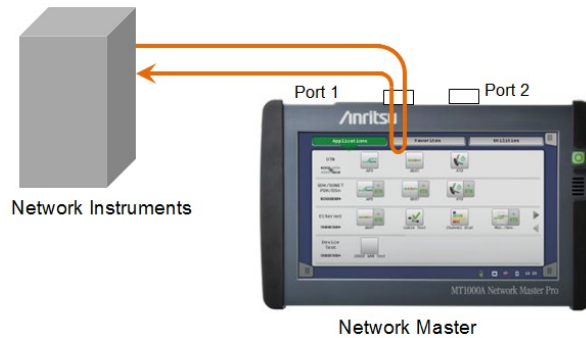

*HDX (Half Duplex) is not possible in 'Reflector' mode.
Multicast or Broadcast frame are not reflected in 'Reflector' mode.*

6.8.1 Ports Setup and Status

The first step in running an application is to set up the port interfaces. This is done on the **Ports Setup** screen, which also provides port status information.

The setup options and status information related to the Ethernet interface are described in a separate section:

- [Ethernet Setup and Status](#)

In Ethernet Setup for Reflector mode, two buttons appear in Navigation area.

- [Swap](#)
- [Settings](#)

Only "Incoming Frames" tab and "Receiver Setup" tab appear.

Incoming Frames tab is different from that in other applications.

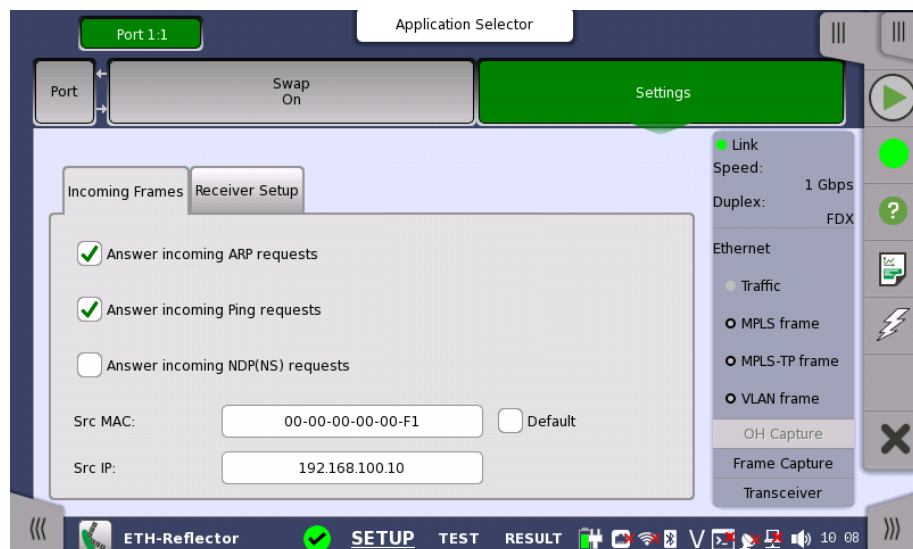

In **Src MAC** and **Src IP**, set the source MAC address and the source IP address of ARP request and Ping request.

For applications also including an OTN interface, you can find a description of the setup options and status information for OTN in the following section:

- [OTN Setup and Status](#)

Please refer to the sections relevant for your current port setup requirements.

6.8.2 Test Setup

6.8.2.1 Control

Refer to "[Control](#)" in BERT Test Setup subsection for the operation.

6.8.2.2 Thresholds

Touching the **Thresholds** button in the navigation area displays the following screen.

The **Follow** button appears when the Port 2 settings can follow Port 1.

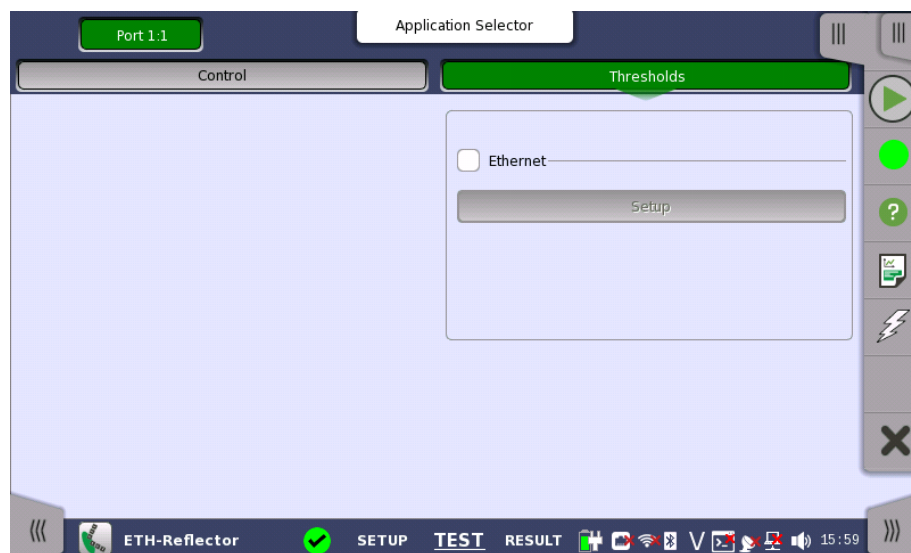

This screen allows you to set up a number of special monitoring items related to the various interface types. When specified and enabled, these threshold values (i.e. limits) for errors and Pass/Fail status will be used during the monitoring.

Total Frame Difference

Allows you to select the reference port to measure the differential time, using **Difference from:** drop down menu.

Ethernet

When you select the check box, you can enable various thresholds. Touch the **Setup** button to display the same **Ethernet threshold setup** dialog box as BERT.

6.8.3 Test Results

6.8.3.1 Summary

When you go to the test results of the Ethernet Reflector application, the following screen is displayed.

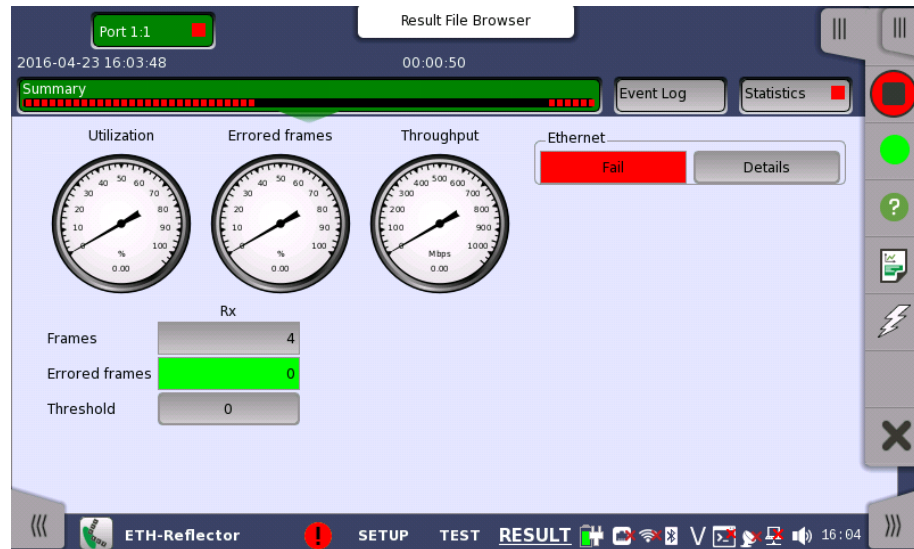

This screen contains a summary of the results of the Ethernet Reflector test. The information includes such things as number of errored frames and number of exceeded thresholds.

The three dials showing utilization/throughput results, pattern errors and errored frames can be enlarged by touching on them. The black needle points the measured value in the latest period.

When **Ethernet** is selected on 'Threshold' of the Test Setup screen, the **Ethernet** information appears in the upper right-hand corner, shows pass/fail status summary. Touching the **Details** button allows you to inspect the individual pass/fail status. Refer to [Summary](#) in BERT section.

6.8.3.2 Event Log

Touching the **Event Log** button in the navigation area displays the screen providing the event log data. Refer to [Event Log](#) of SDH/SONET/PDH/DSn BERT application.

6.8.3.3 Statistics

Touching the **Statistics** button in the navigation area displays the screen providing the statistics data. Refer to [Statistics](#) of BERT for the operation.

6.9 RFC 2544



The RFC 2544 is a benchmarking methodology and defines a number of tests to be used for describing the performance characteristics of a network device (or a complete network). The Network Master includes several physical setups (test modes) and four different tests.

Throughput Test

The throughput is the fastest rate at which a DUT (Device Under Test) can forward frames without frame loss for a specific frame size. That is, the fastest rate at which the count of test frames transmitted by the DUT is equal to the number of test frames sent to it by the test equipment.

Frame Loss Test

Used to determine the frame loss rate of a DUT throughout the entire range of input data rates and frame sizes.

Latency Test

Used to determine the duration from when the frame left the unit to when the frame returned to the unit. The test is done for different line loads for a specific frame size.

Burst Test

This is also called burstability or back-to-back test. The burst value is the number of frames in the longest burst that the DUT will handle without the loss of any frames.



If your test parameters are identical for the throughput and the frame loss test, use the combined test 'Throughput and Frame loss' to save time and enhance overview at the results pages.

6.9.1 Ports Setup and Status

The first step in running an application is to set up the port interfaces. This is done on the **Ports Setup** screen, which also provides port status information.

The setup options and status information related to the Ethernet interface are described in a separate section:

- [Ethernet Setup and Status](#)

For applications also including an OTN interface, you can find a description of the setup options and status information for OTN in the following section:

- [OTN Setup and Status](#)

Please refer to the sections relevant for your current port setup requirements.

6.9.2 Test Setup

Restriction of Number of Steps

RFC 2544 measures the throughput, frame loss, latency, and burst while changing the load applied to the DUT by changing the transmission rate and size of the Ethernet frame. In addition to the final results, Network Master retains the measurement results at each load as an intermediate results, but 500 steps are retained at maximum. Depending on the setting of the steps, it is possible to retain more than 500 steps, but in that case the oldest measurement result(s) will be discarded.

Also, depending on the setting, only the results of one category (throughput, frame loss, latency, or burst) may be retained in large amount disproportionately. In order to avoid this, Network Master organizes the results so that results at least 100 steps remain as shown in the examples below.

Example 1

Test	Number of Steps set in Setup	Number of steps in which the measurement results are retained
Throughput	100	100
Frame loss	200	200
Burst	500	200*

*: Measurement results for the first 300 steps are discarded.

Example 2

Test	Number of Steps set in Setup	Number of steps in which the measurement results are retained
Throughput	500	300 ^{*1}
Frame loss	200	100 ^{*2}
Burst	100	100

*1: Measurement results for the first 200 steps are discarded.

*2: Measurement results for the first 100 steps are discarded.

However, when the test mode is [End to End](#), results up to 100 steps are retained.

Example 3 When the test mode is **End to End**.

Test	Number of Steps set in Setup	Number of steps in which the measurement results are retained
Throughput	100	100
Frame loss	200	100 ^{*1}
Burst	500	100 ^{*2}

*1: Measurement results for the first 100 steps are discarded.

*2: Measurement results for the first 400 steps are discarded.

In the test setting, the total number of steps can be set to more than 500. In this case, a warning is displayed on the [Summary](#) screen when the measurement is started.

The number of test steps can be calculated by the following formula.

Number of steps = $f \times (r+1) \times l$
 f: Number of Frame Size steps
 r: Repeats
 l: Number of Line Load steps

In the following setting example, the number of steps is 100.

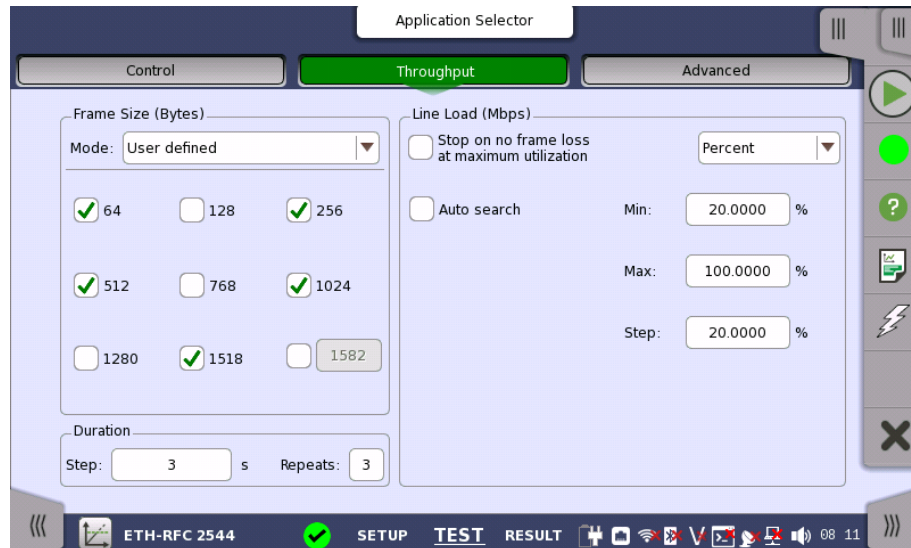

f=5 Five frame sizes, 64, 256, 512, 1024, and 1518 bytes are selected.

r=3 One measurement is repeated three times after the first measurement, which means four times for each.

l=5 With the settings of Min. 20%, Max. 100%, and Step 20%, line load steps are five, 20%, 40%, 60%, 80%, and 100%.

Number of steps = $f \times (r+1) \times l = 5 \times (3+1) \times 5 = 100$



*When **Accumulate repeated steps** in the [Advanced](#) screen is selected, $r=0$ regardless of the set value of **Repeats**.*

6.9.2.1 Control

When you go to the test setup of the RFC 2544 application, the following screen is displayed.

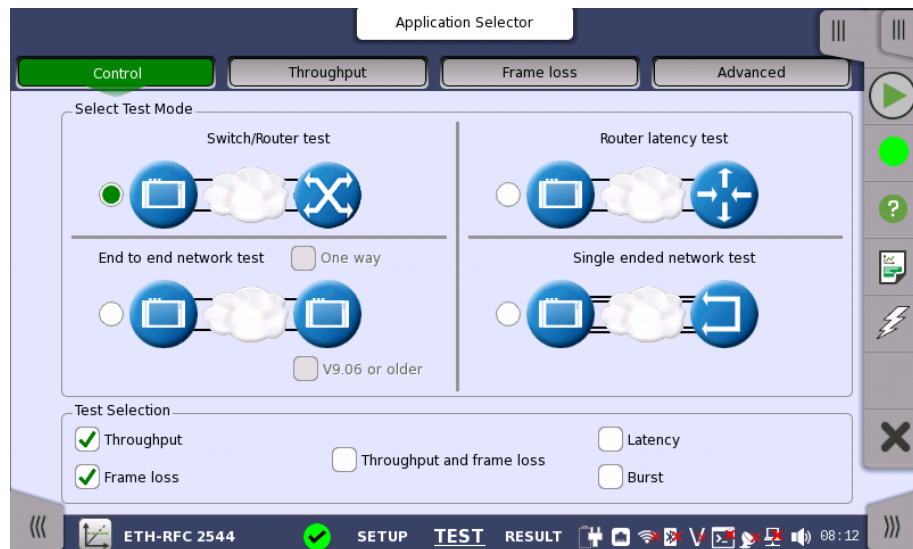

This screen allows you to specify your test mode and select which RFC 2544 tests to carry out.

Select Test Mode

4 different test modes are available:

- [Switch/Router test](#)
- [Router latency test](#)
- [End to end network test](#)
- [Single ended network test](#)



Switch/Router test uses two ports to perform tests. When only one port is selected at starting RFC 2544 application, it is not able to start Switch/Router test.

Select the test mode to define your test configuration. See the description of the test modes below.

Test Selection

Select one or more of the following [RFC 2544 tests](#):

- [Throughput](#)
- [Frame loss](#)
- [Throughput and frame Loss](#)
- [Latency](#)
- [Burst](#)



For each test that you select, a separate test setup screen will become available, containing the relevant setup parameters for that test. Similarly, the test results will include only the tests that you have selected in 'Test Selection'.

Test Mode Descriptions

Switch/Router test



In this test mode one instrument is able to test, e.g. the data link layer of a switch or router. Both ports must be active and linked in this mode, with port 2 in follow port 1 mode. IP and MAC-addresses must be swapped, ensuring that the switch will forward frames from port 1 to port 2 and vice versa.

Testing in this mode

- Throughput test
- Frame Loss test

- Throughput and Frame Loss test
- Latency test
- Burst test



Both ports must be activated in order to perform the Switch/Router test. You cannot select 'Throughput and Frame Loss' and 'Throughput' / 'Frame Loss' at the same time.

Router latency test



In this test mode, the latency-test sends out ping frames, used for measuring the response time for router equipment. The maximum line load for the Router Latency Test is 1 Mbps.

The Network Master is capable of responding to incoming ping frames, and can thus be used to run the Router Latency Test port to port, if required.



When the instrument is used to reply to incoming ping frames, the settings of the Encapsulation type and VLAN/no VLAN in port traffic setup will decide which ping requests to answer. So do VLAN ID and Address setups.

The Router Latency Test works with both IPv4/ICMPv4 and IPv6/ICMPv6.

Testing in this mode

- Latency test

End to end network test



In this test mode, two Network Masters will work together performing an RFC 2544 test. The Network Master which users actually operate to perform RFC2544 test is the *Local* and the other Network Master which sends and receives Ethernet frames via the network under test is the *Remote*.

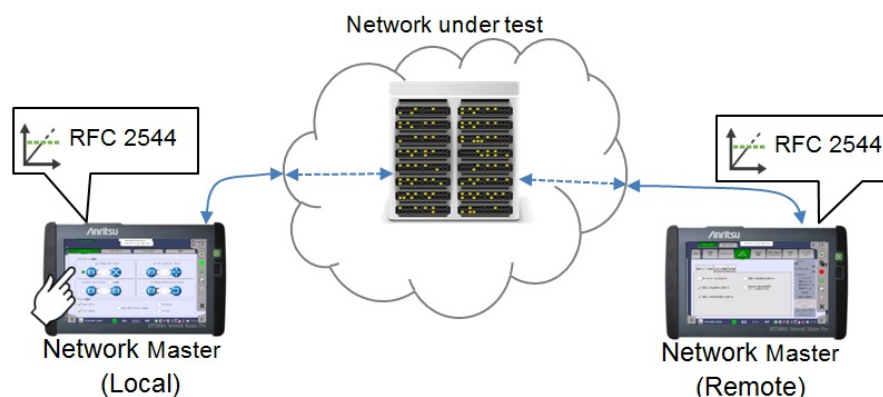

After starting RFC2544 test, the 'local' Network Master tries to control the 'remote' Network Master via the network under test. To control the 'remote' Network Master, 'local' Network Master starts communication using Dest. MAC address and Dest. IP address set on the Stream screen. Therefore, destination addresses of the 'local' Network Master and source addresses of the 'remote' Network Master should be set to the same. Also, enable **Accept Network Master Configuration frames** option on [Incoming Frames](#) tab of the Setting screen on the 'remote' Network Master.

Before starting the test, confirm the software versions of both 'local' Network Master and 'remote' Network Master.

When the software version of 'remote' Network Master is the same as or later than that of 'local' Network Master:

You can perform tests with no restriction.

Other than the above case:

You can perform tests by one of following methods:

- Update the software version of 'remote' Network Master (recommended).
- Select the **V9.06 or older** check box.

When the **V9.06 or older** check box is selected, the following function is restricted.

- **Flexible** option of Frame Size (Bytes) in each setup

The required setup to perform RFC 2544 test is transferred from the 'local' Network Master to the 'remote' Network Master when the test is started.



When the test is started on the 'local' Network Master, a popup will appear on the 'remote' Network Master, telling that the unit is being remotely controlled - providing a 'break connection' button. The popup will disappear when the test is completed or stopped on the 'local' Network Master.

When the test is completed, the test results are transferred from the 'remote' Network Master to the 'local' Network Master. **Remote 1** and **Remote 2** buttons appear in Navigation area for displaying the 'remote' side test results.

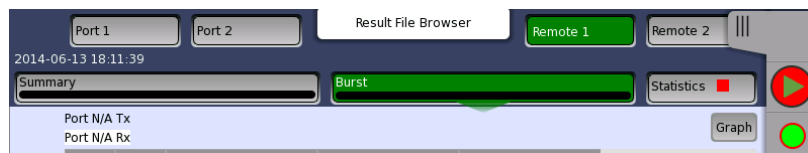

The local results and 'remote' results are related in the way that Tx statistics for the local ports match up with the Rx statistics for the remote ports and vice versa.

The End to End Test can be run in several modes: By default, both of Port 1 and Port 2 are used for transmitting and receiving on both the 'local' Network Master and the 'remote' Network Master. Depending on the address setup the test will run either Local port 1 > Remote port 1, and Local port 2 > Remote port 2 or vice versa.

If **One Way** is selected, the test will transmit frames from either the 'remote' Network Master or the 'local' Network Master. The direction Ethernet frames are sent can be set at [End to End Test \(master side\)](#) in **Advanced**.

Testing in this mode

- Throughput test
- Frame Loss test
- Throughput and Frame Loss test
- Burst test

Note that you cannot select 'Throughput and Frame Loss' and 'Throughput' / 'Frame Loss' at the same time.

Single ended network test



This test is used when testing network by reflecting traffic back to the Network Master. This requires a device to reflect the traffic back e.g. a second Network Master.



If both ports are active, the test will require both ports to be linked and do a dual 'Single ended network test'. Turn off one of the ports to only test on one of the ports.

Testing in this mode

- Throughput test
- Frame Loss test
- Throughput and Frame Loss test
- Latency test
- Burst test

Note that you cannot select 'Throughput and Frame Loss' and 'Throughput' / 'Frame Loss' at the same time.

6.9.2.2 Throughput

Only available if you have specified a Throughput test on the 'Control' of the Test Setup screen.

Touching the **Throughput** button in the navigation area will display the screen shown below.

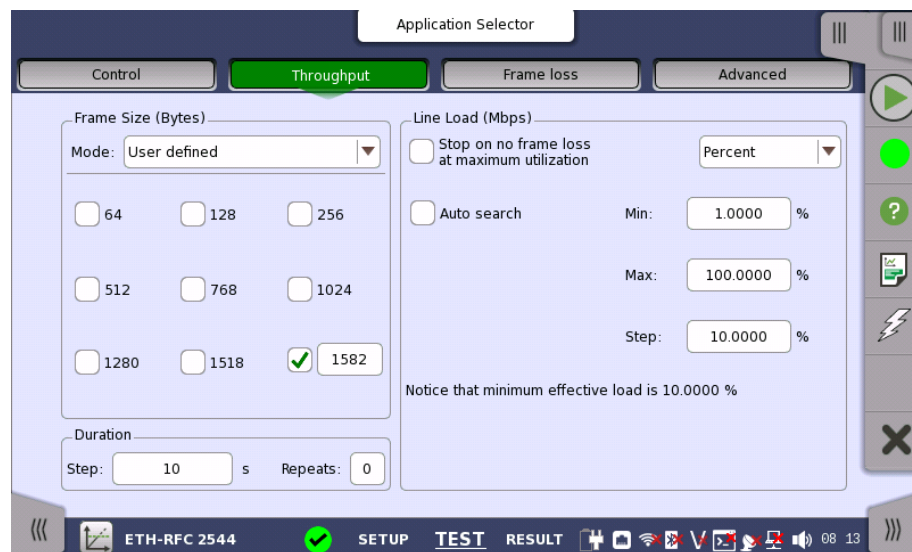

This screen allows you to configure the following parameters related to an RFC 2544 Throughput test:



The changes affect both Port 1 and Port 2 when the Switch/Router Test mode is selected.

Frame Size (Bytes)

Frame size can be specified in four ways. Observe that the screen layout changes depending on the type of Frame Size selected.

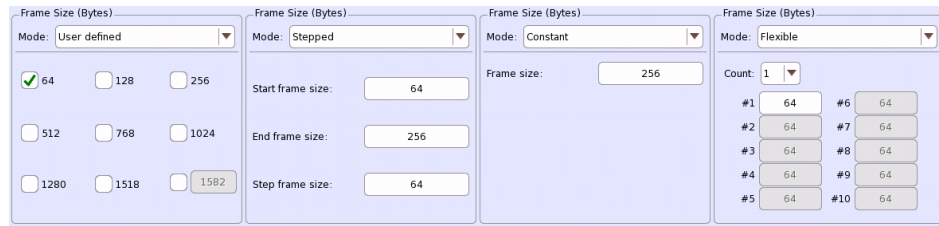

User defined

Check boxes for the following predefined sizes are available: **64, 128, 256, 512, 768, 1024, 1280, 1518** and **1519 to 16000**(Using the field at right bottom).

Stepped

Setup of **Start frame size**, **End frame size** and **Step frame size** is available. The frame size starts at *Start frame size* and increases/decreases in intervals of *Step frame size* until the frame size is above/below *End frame size* (the increase or decrease depending on the specified start and end values).

Constant

A **Frame size** field for specifying the constant size is available.

Flexible

This option allows users to select multiple frame sizes from arbitrary frame length.

Set number of frame sizes to apply in **Count**, and input a frame length in each frame size text box.



The 'stepped' mode is convenient for testing different frame sizes consistently and equally distributed. As a consequence it produces more smooth and detailed graphs when the step frame size is arbitrarily low. The test extends in time for smaller step frame sizes.



*When selecting **Flexible**, one result is displayed for one frame length. If multiple frame sizes whose value is same are set, the measured results of them are merged and displayed in one result.*

Frame size is protocol headers and payload combined. Frame size does not include preamble and interframe gap.

Line Load (Mbps)

The different test line loads used in the test are specified as a Minimum (**Min**) and Maximum (**Max**) - varied in intervals of the value specified in the **Step** field. The test always starts at Maximum line load and decreases until the line load is less than Minimum. The results can be presented in either **Mbps** or as **Percent**.

Valid range of *Min, Max, Step* depends on the unit and Ethernet interface.

Percent

0.0008 to 100.0000 %.

Mbps

10M interface: 0.00008 to 10.000 Mbps *¹

100M interface: 0.0008 to 100.00 Mbps *¹

1G interface: 0.008 to 1000.00 Mbps *¹

10G interface: 0.08 to 10000.00 Mbps *²

*1: Setting is only available with the Ethernet 10/100/1000 interface.

*2: Setting is only available when the Ethernet 10 Gig option is installed.

Stop on no frame loss at maximum utilization

The test will continue to test the next frame size if the current test step at a specific line load and frame size does not have any frames lost.

Auto search

Allows you to let the test automatically find the maximum line load that gives zero frame loss, using a specified resolution. Auto Search can run in one of the two following modes:

- **Smart** that assumes that there is a higher probability of frame loss occurring closer to Max, and therefore makes a skewed binary search searching the higher line loads first.
- **Binary** that will perform a binary search of the specified line load interval from Max to Min.

The **Resolution** field lets you specify the precision of the auto search. A higher precision extends the duration of the test. Available resolutions are: **0.1**, **1.0** and **10.0** %.



The check boxes are enabled except when selecting 'End to End network test' on Control screen.

Duration

Step

Specify the approximate duration in time of each step of the test. It can be set to a number of seconds (minimum 3 seconds).

Repeats

Specify the number of times the complete test will repeat. Valid range: **0** to **1000**.

6.9.2.3 Frame Loss

Only available if you have specified a Frame Loss test on the 'Control' of the Test Setup screen.

Touching the **Frame loss** button in the navigation area will display the screen shown below.

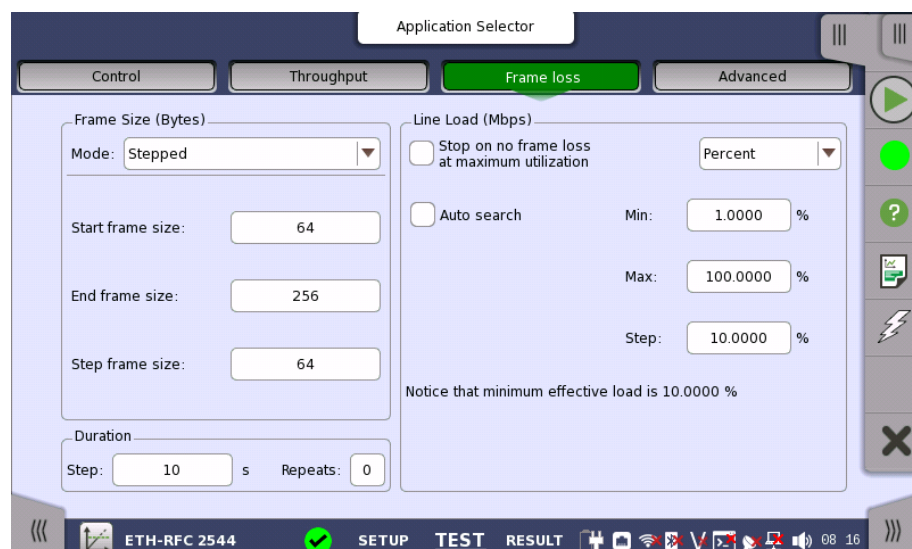

This screen allows you to configure the following parameters related to an RFC 2544 Frame Loss test:

- [Frame Size](#)
- [Line Load](#)
- [Duration](#)

The parameters are identical to the ones described in the *Throughput* section above.

6.9.2.4 Throughput and Frame Loss

Only available if you have specified a 'Throughput and Frame Loss' test on the 'Control' of the Test Setup screen. Use this test if you want to perform both a Throughput test and a Frame Loss test while using the same test parameters for both.

Touching the **Throughput and frame loss** button in the navigation area will launch the screen shown below.

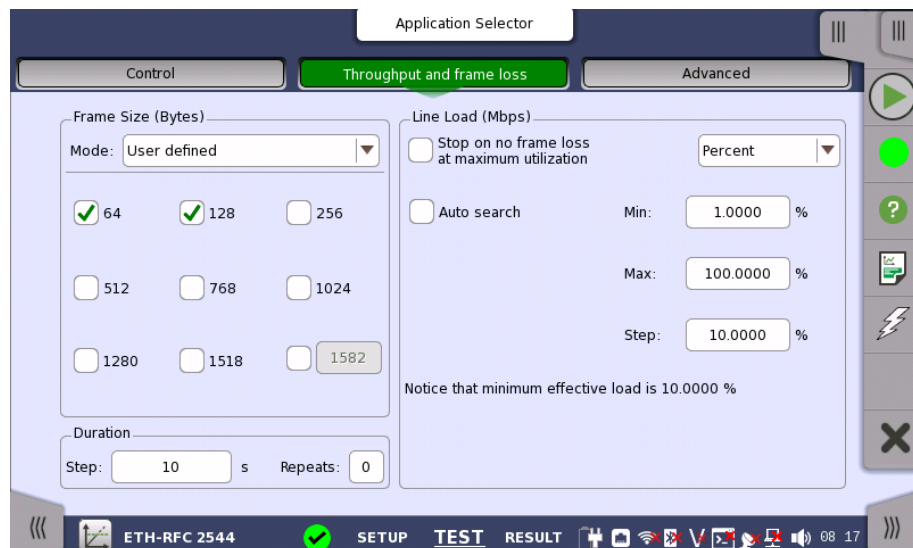

This screen allows you to configure the following parameters related to an RFC 2544 Throughput and Frame Loss test:

- [Frame Size](#)
- [Line Load](#)
- [Duration](#)

The settings for 'Throughput and Frame Loss' are identical to the ones described in the *Throughput* section above.

6.9.2.5 Latency

Only available if you have specified a Latency test on the 'Control' of the Test Setup screen.

Touching the **Latency** button in the navigation area will display the screen shown below.

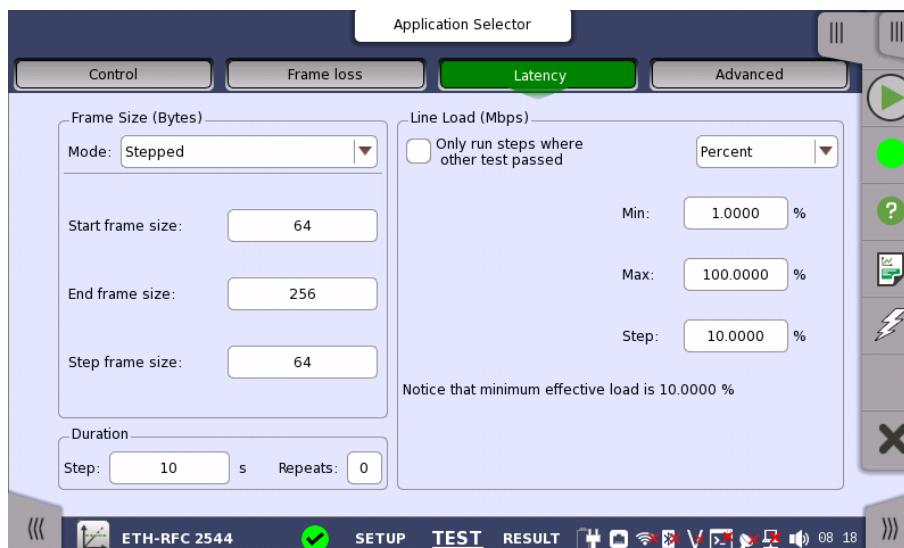

This screen allows you to configure the parameters related to an RFC 2544 Latency test:

- [Frame Size](#)
- [Line Load](#)
- [Duration](#)

Most of the settings for Latency are identical to the ones described above in the *Throughput* section. Please see the detailed descriptions in that section in addition to the Latency-specific information provided here.

Only run steps where other test passed

If selecting the check box, the latency test will be done only on the line load steps where other test has passed (i.e. no frame loss).

The other tests can be selected from: **Throughput**, **Frame Loss**, and **Throughput and Frame Loss**.

You can specify a tolerance level of the line load in percent ratio of the utilization.

Example when other test is **Throughput** and Tolerance level is 80:

Throughput test			Line load of Latency test
Frame size (byte)	Utilization (%)	Result	
64	100	Fail	(Not tested)
64	60	Pass	48
64	20	Pass	16



When 'Only run steps where other test passed' is selected, all other settings are forced identical for the Frame Loss and Latency tests.

'Only run steps where other test passed' is enabled in case of 'Switch/Router test' or 'Single ended network test'.

If duration 'Repeats' is set to 0 (zero), the test will run a single time. If it is set to 1, the test will run two times (repeated once).

6.9.2.6 Burst

Only available if you have specified a Burst test on the 'Control' of the Test Setup screen.

Touching the **Burst** button in the navigation area will display the screen shown below.

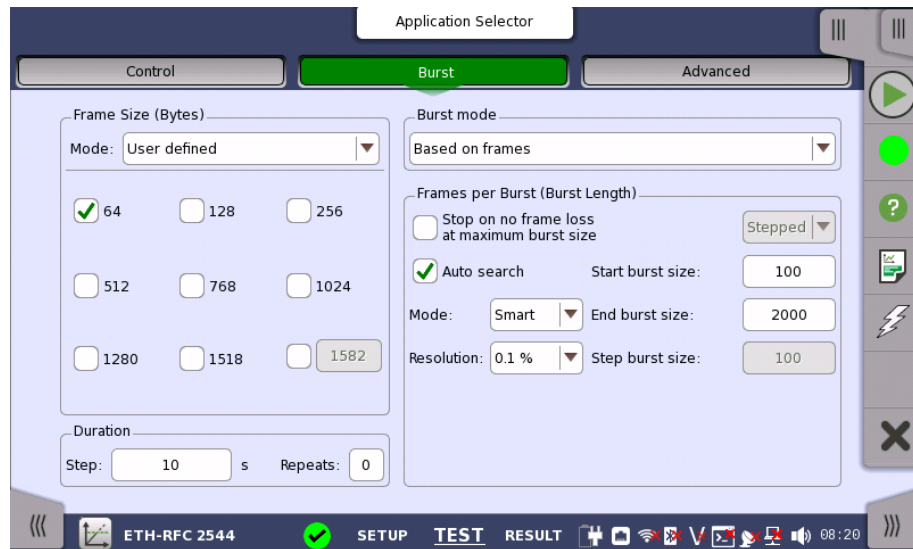

This screen allows you to configure the following parameters related to an RFC 2544 Burst test:

- [Frame Size](#)
- [Frames per burst \(burst length\)](#) or [Seconds per burst \(burst length\)](#)
- [Duration](#)

Frame Size and *Duration* are identical to the ones described above in the *Throughput* section. Please see the detailed descriptions in that section in addition to the Burst-specific information provided here.

Burst mode

Select how to set burst length.

- **Based on frames:** sets burst length by multiples of Ethernet frame size.
- **Based on seconds:** sets burst length by time.

Frames per Burst (Burst Length)

The number of frames per burst can either be varied (selecting **Stepped** in the drop-down menu) or constant (selecting **Constant**).

Stepped works like *Stepped* for frame sizes, i.e. the test starts with **Start burst Size** and in intervals of **Step burst size** increases or decreases to **End burst size**.

Constant allows you to specify a *Start burst size*.

Stop on no frame loss at maximum burst size

If selected, the burst test stops on no frame loss at maximum burst size.

Auto search

If selected, the burst length is searched automatically. Select the search method from **Mode**. Select the search resolution from **0.1 %**, **1.0 %**, or **10.0 %**.



The check boxes are enabled except when selecting 'End to End network test' on Control screen.

If duration 'Repeats' is set to 0 (zero), the test will run a single time. If it is set to 1, the test will run two times (repeated once).

Seconds per Burst (Burst Length)

When setting burst length by seconds, the burst length is searched automatically. Select the search resolution from 0.1 %, 1.0 %, or 10.0 %. Select the search method from **Mode**.

6.9.2.7 Advanced

Touching the **Advanced** button in the navigation area will display the screen shown below.

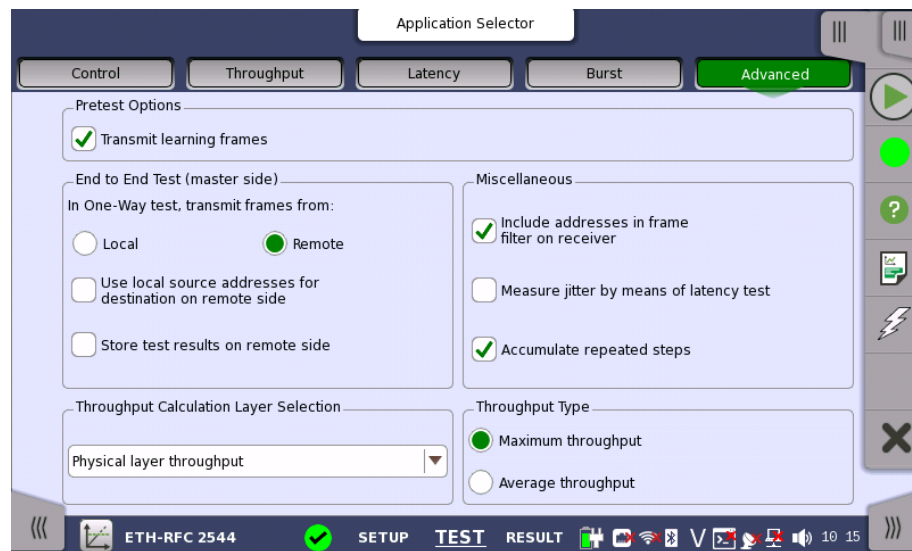

This screen allows you to specify various advanced settings for the RFC 2544 test(s).

- [Pretest Options](#)
- [End to End Test \(master side\)](#)
- [Miscellaneous](#)
- [Throughput Calculation Layer Selection](#)
- [Throughput Type](#)

Pretest Options

Transmit learning frames

When this option is enabled, the RFC 2544 test will send out a number of 'learning frames' before the first test-step starts on each port. This happens to train network equipment, so that initial latency results will not be invalid.

End to End Test (master side)

In One-Way test, transmit frames from

This parameter defines the direction of the frames when transmitted during an End to End test with the One-Way setting enabled. Available directions are:

- **Local:** The 'local' Network Master sends Ethernet frames to the 'remote' Network Master.
The 'remote' Network Master measures the received frames.
- **Remote:** The 'remote' Network Master sends Ethernet frames to the 'local' Network Master.
The 'local' Network Master measures the received frames.

Use local source addresses for destination on remote side

When this function is enabled, the Network Master does not use the IP or MAC addresses for differentiating frames during the RFC 2544 test. An exception is End to End test control, but routing equipment in the network may need the addresses to be set up correctly. To limit the amount of needed setups on the Remote side, this setting can be enabled to transfer the source address setup from the Local using it as destination on the Remote. However, the source addresses must still be correctly setup on the remote in order to make the End to End test work.

Store test results on remote side

When this function is enabled, test results will be stored on the 'remote' Network Master.

Miscellaneous

Include addresses in frame filter on receiver

When enabling this function, the Ethernet frames which their destination addresses match the following items will appear on the [Streams](#) screen.

- Src MAC
- Src IP
- VLAN ID
- Src Port

This setting has an effect on only the following measurement results on the Statistics screen.

- Multi Stream Transmit
- Multi Stream Throughput
- Multi Stream Frame Loss
- Multi Stream Latency
- Multi Stream Jitter

This setting does not have an effect on [Frame Capture](#).

Measure jitter by means of latency test

When selected the Latency Test will measure jitter instead of latency.

Accumulate repeated steps

The RFC 2544 test (Throughput, Frame loss, Latency, and Burst) is performed by steps by means of changing a parameter value. When selecting the check box, the results of each steps are accumulated by each test when the tests are repeated.

Throughput Calculation Layer Selection

Select the layer on which the throughput calculation is done. As described in the [Throughput calculation](#) section there are 6 different layers:

- Utilization layer throughput
- Physical layer throughput
- Physical layer throughput (without preamble)
- Link layer throughput
- Network layer throughput
- Data layer throughput

Data layer throughput appears when UDP or TCP is set to the layer 4 of the Ethernet frame on 'Ports Setup' screen.

Throughput Type Select whether to register **Average throughput** or **Maximum throughput**.

6.9.3 Test Results

Graphical presentation

The results of the performed RFC 2544 tests can be presented in either tabular form or as graphical representations. The graphical presentation mode provides an overview of the results and the progress of the test.

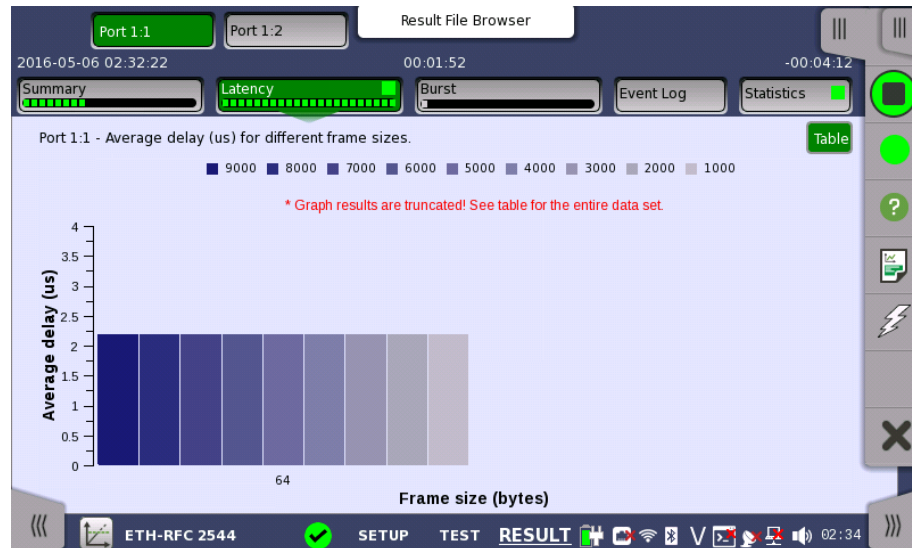

On the test-specific result screen, you switch between the two modes by using the **Graph** and **Table** buttons.

6.9.3.1 Summary

When you go to the test results of the Ethernet RFC 2544 application, the following screen is displayed.

Test	Status
Throughput	Completed
Frame loss	Running
Latency	Configured / Not started
Burst	Configured / Not started
Throughput and frame loss	Not configured

This screen presents the current status of the test(s) (**Configured / Not Started**, **Running**, **Completed** or **Not Configured**). Touching the status button for a specific test will display the result screen of the test.

6.9.3.2 Throughput

Touching the **Throughput** button in the navigation area will display the screen shown below.

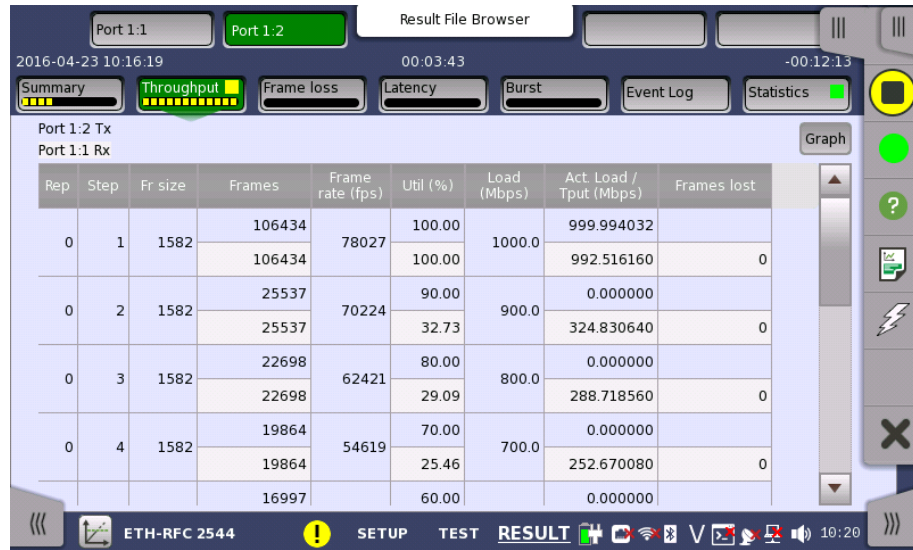

This screen presents the results from the Throughput test.

The most important columns of the tables are the varied main parameters *Frame size* and *Throughput* and the performance parameter *Frames lost*.



The order of the tables will vary depending on the test mode and the relation of the ports.

Test Mode	Port 1	Port 2
Switch/Router test	Port 1 Tx Port 2 Rx	Port 2 Tx Port 1 Rx
End to End test		
Router latency test	Port 1 Tx Port 1 Rx	Port 2 Tx Port 2 Rx
Single ended network test		

6.9.3.3 Frame loss



Only available if you have specified a Frame loss test on the 'Control' of the Test Setup screen.

Touching the **Frame loss** button in the navigation area will display the screen shown below.

Rep	Step	Fr size	Frames	Frame rate (fps)	Util (%)	Load (Mbps)	Act. Load / Tput (Mbps)	Frames lost	Loss rt (%)
0	1	64	529663	1488095	100.00	1000.0	0.000000	0	0.00
			529663		35.59		305.085888		
0	2	64	479932	1339285	90.00	900.0	0.000000	0	0.00
			479932		32.25		276.440832		
0	3	64	425280	1190476	80.00	800.0	0.000000	0	0.00
			425280		28.58		244.961280		
0	4	64	1.413916 M	1041666	70.00	700.0	700.000896	0	0.00
			1413916		70.00		600.001344		
			320231		60.00		0.000000		

This screen presents the results from the Frame loss test.

The most important columns of the tables are the varied main parameters *Frame size* and *Throughput* and the performance parameter *Loss rate*.



The order of the tables will vary depending on the test mode and the relation of the ports. Refer to the table in "Throughput" subsection of "Test Results".

6.9.3.4 Throughput and frame loss

Touching the **Throughput and frame loss** button in the navigation area will display the screen shown below.

Rep	Step	Fr size	Frames	Frame rate (fps)	Util (%)	Load (Mbps)	Act. Load / Tput (Mbps)	Frames lost	Loss rt (%)
0	1	64	770637	1488095	100.00	1000.0	0.000000	0	0.00
			770637		51.79		443.886912		
0	2	64	693476	1339285	90.00	900.0	0.000000	0	0.00
			693476		46.60		399.442176		
0	3	64	616236	1190476	80.00	800.0	0.000000	0	0.00
			616236		41.41		354.951936		
0	4	64	538369	1041666	70.00	700.0	0.000000	0	0.00
			538369		36.18		310.100544		
			1.354479 M		60.00		600.000576		

This screen presents the results from the Throughput and frame loss test.

The most important columns of the tables are the varied main parameters *Frame size* and *Throughput* and the performance parameters *Frames lost* and *Loss rate*.



The order of the tables will vary depending on the test mode and the relation of the ports. Refer to the table in "Throughput" subsection of "Test Results".

6.9.3.5 Latency

Touching the **Latency** button in the navigation area will display the screen shown below.

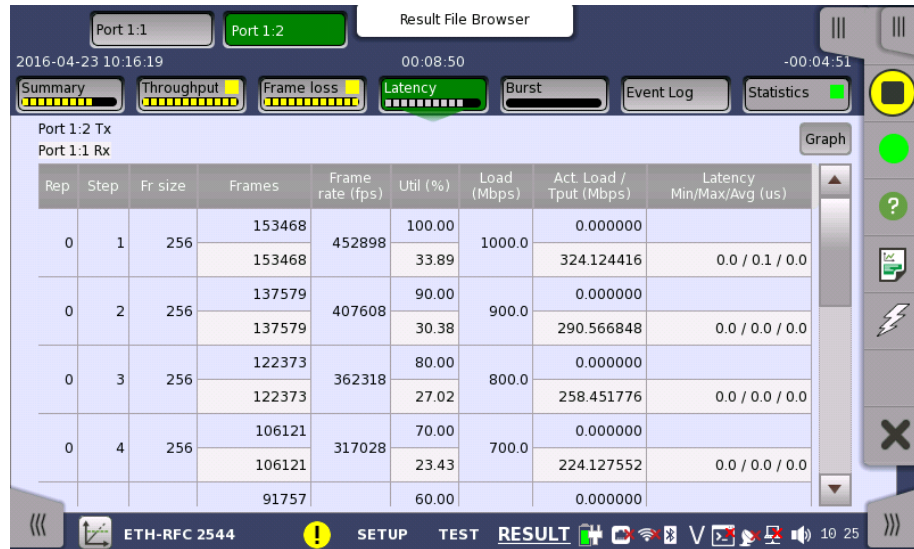

This screen presents the results from the Latency test.

The most important columns of the tables are the varied main parameters *Frame size* and *Throughput* and the performance parameters *Min*, *Avg* and *Max* latency stated in micro seconds.



The order of the tables will vary depending on the test mode and the relation of the ports. Refer to the table in "Throughput" subsection of "Test Results".

6.9.3.6 Burst

Touching the **Burst** button in the navigation area will display the screen shown below.

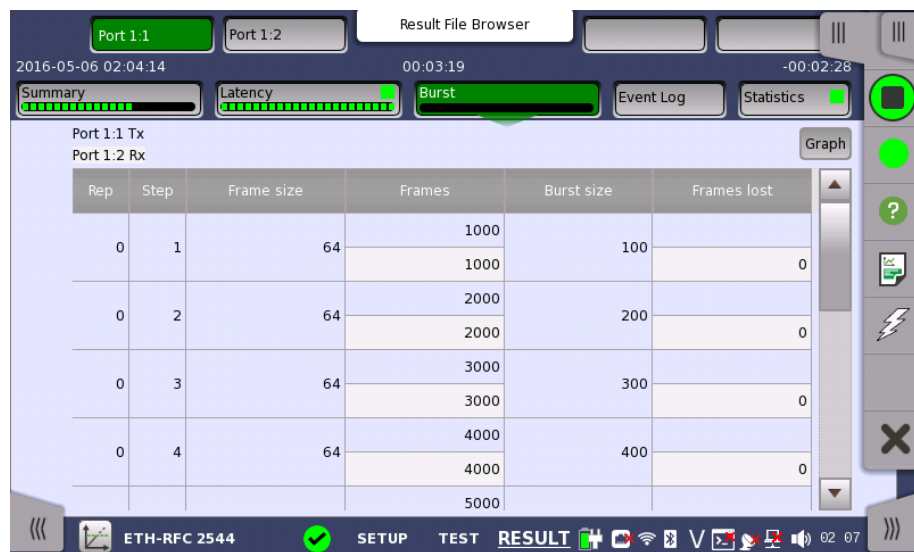

This screen presents the results from the Burst test.

The most important columns of the tables are the varied main parameters *Burst size* and *Frame size* and the performance parameter *Frames lost*.



The order of the tables will vary depending on the test mode and the relation of the ports. Refer to the table in "Throughput" subsection of "Test Results".

6.9.3.7 Event Log

Touching the **Event Log** button in the navigation area displays the screen providing the event log data. Refer to [Event Log](#) of SDH/SONET/PDH/DSn BERT application.

6.9.3.8 Statistics

Touching the **Statistics** button in the navigation area displays the screen providing the statistics data. Refer to [Statistics](#) of Mon/Gen for the operation.

6.9.4 Throughput Calculation

Throughput may be calculated on 6 different layers.

Throughput Calculation	Frame Representation											
Data layer	IFG	Preamble	MAC header	MPLS (opt)	PBB (opt)	VLAN (opt)	LLC (opt)	SNAP (opt)	IP header	UDP TCP	PAYLOAD	CRC
Network layer	IFG	Preamble	MAC header	MPLS (opt)	PBB (opt)	VLAN (opt)	LLC (opt)	SNAP (opt)	IP header	UDP TCP	PAYLOAD	CRC
Link layer	IFG	Preamble	MAC header	MPLS (opt)	PBB (opt)	VLAN (opt)	LLC (opt)	SNAP (opt)	IP header	UDP TCP	PAYLOAD	CRC
Physical layer, no preamble	IFG	Preamble	MAC header	MPLS (opt)	PBB (opt)	VLAN (opt)	LLC (opt)	SNAP (opt)	IP header	UDP TCP	PAYLOAD	CRC
Physical layer	IFG	Preamble	MAC header	MPLS (opt)	PBB (opt)	VLAN (opt)	LLC (opt)	SNAP (opt)	IP header	UDP TCP	PAYLOAD	CRC
Utilization layer	Min. IFG	Preamble	MAC header	MPLS (opt)	PBB (opt)	VLAN (opt)	LLC (opt)	SNAP (opt)	IP header	UDP TCP	PAYLOAD	CRC
Frame information	<div style="text-align: center;"> </div>											

Each calculation is done on a one second base. It is possible either to register the maximum throughput (actually showing only the second with the highest throughput), or to register an *average throughput per second* taken over a selected part of the test period.



The calculation depends on the setting of the transmitted frame contents. Even in cases where the transmitter is not used, the calculation will be based on this setting.

The part of the test from which the average throughput is calculated, is selected in a way to avoid influence from latency and missing frames. The drawing below illustrates this.

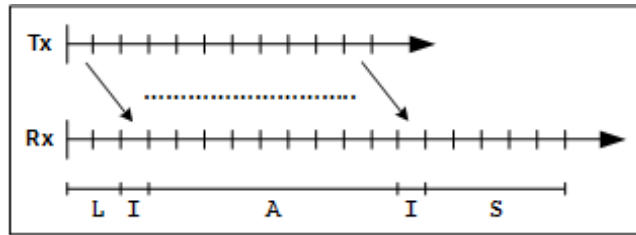

The **Tx** graph shows the transmitted periods, and the **Rx** graph shows the received periods. Due to latency the receiver will first see the transmitted frames some time later than when transmitter actually sent the frames (the L-period). This is also why the receiver may have more periods than the transmitter, in order to await delayed frames. However the receiver will maximum wait for 10 extra periods (seconds) before it times out, as frames may actually physically be lost somewhere in the network.

The average calculation is triggered when the receiver actually sees the first frame. The frames in this first I-period are ignored. Then the average calculation is started and runs over the next duration-2 A-periods. Frames in the last I-period are also ignored. Frames in the remaining S-periods have no influence on the average calculation.

6.10 RFC 6349



The RFC 6349 *Framework for TCP Throughput Testing* describes a practical methodology for measuring end-to-end TCP Throughput in a managed IP network.



For using RFC 6349 application, TCP Throughput option is required to the test module. If the option has been installed, RFC 6349 icon will appear in Application Selector.

The Network Master has the test sequence according to RFC 6349.

1. Path MTU
Identifies the maximum IP packet size passing through the network without fragmentation.
2. Baseline Round Trip Time (RTT)
Measures the lowest RTT assuming that packets pass through the network without congestion.
3. Window Scan and Throughput
While scanning the TCP window size, measures the maximum bit rate of the end-to-end network path.
The window size scanning method can be set by **Test Mode**.
4. Multi-Service
Measures multiple-TCP connection throughput. Multiple TCP connection throughput test is called "Multi-Service" in Network Master.

The RFC 6349 also defines TCP metrics as [Transfer Time Ratio](#), [TCP Efficiency](#) and [Buffer Delay](#).

6.10.1 Ports Setup and Status

The first step in running an application is to set up the port interfaces. This is done on the **Ports Setup** screen, which also provides port status information.

The setup options and status information related to the Ethernet interface are described in a separate section:

- [Ethernet Setup and Status](#)

In Ethernet Setup for RFC 6349 test, three buttons appear in Navigation area.

- Streams
Layer 4 settings is fixed to "TCP".
- Settings
"Miscellaneous" tab does not appear.
- Filter



The following addresses cannot be used for RFC 6349 application tests.

- All numbers are zero. (i.e. 0.0.0.0 for IPv4, :: for IPv6)
- Multicast address

When Layer 3 is IPv6, tests can be performed if link local addresses (First 16 bits of prefix is FE80) meet the following requirements:

*Requirement 1: Both Src IP address and Src IP address are link local addresses.
Requirement 2: Src IP address satisfies the followings.*

- Prefix: FE80:0000:0000:0000
- Interface ID: Modified EUI-64 format generated from Src. MAC

Please refer to the sections relevant for your current port setup requirements.

6.10.2 Test Setup

6.10.2.1 Control

When you go to the test setup of the RFC 6349 application, the following screen is displayed.

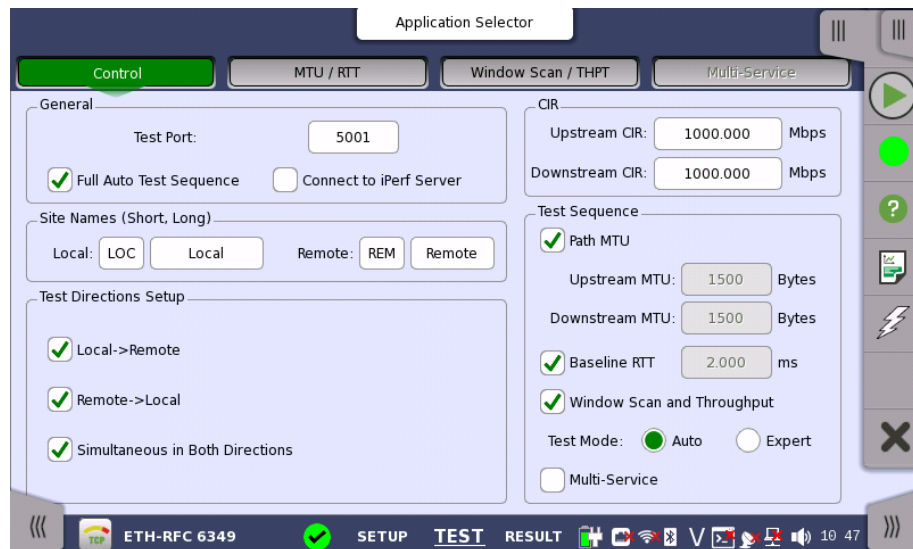

This screen allows you to specify your test mode and select which RFC 6349 tests to carry out.

General

Test Port

Touch the fields to set the port number.

On Local side, "Test port" is used as the TCP destination port.

On Remote side, "Test port" is used as the TCP source port.

Full Auto Test Sequence

If selecting check box, followings are selected:

Local -> Remote, Remote -> Local, Simultaneous in Both Directions, Path MTU, Baseline RTT, Window Scan and Throughput The Test Mode will be set to **Auto**. **Connect to iPerf Server** is cleared.

Connect to iPerf Server

If selecting check box, Network Master will connect to the iperf server. "iperf" is the tool to measure the network throughput.

Followings are cleared:

Remote -> Local, Simultaneous in Both Directions, Full Auto Test Sequence.



Network Master supports iPerf2 only.

Site Names (Short, Long)

In RFC 6349 mode, two Network Masters will work together performing a test. The Network Master which users actually operate to perform RFC 6349 test is the *Local* and the other Network Master which sends and receives Ethernet frames via the network under test is the *Remote*.

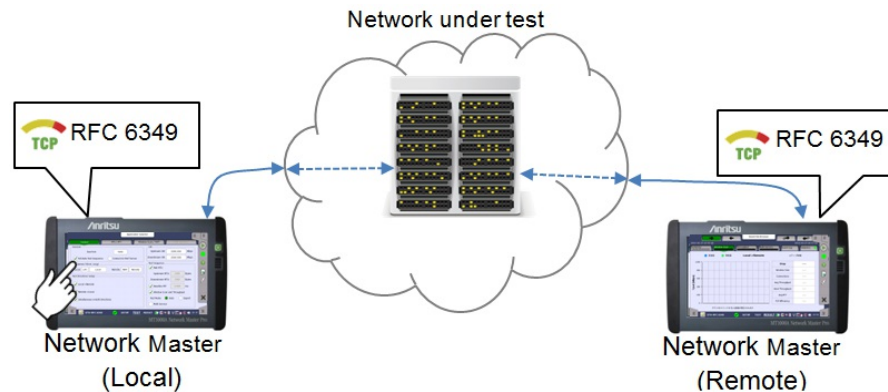

The required setup to perform RFC 6349 test is transferred from the 'local' Network Master to 'remote' Network Master when the test is started.

Touch the fields to set the Site Names :

- **Local:** The site name for 'local' Network Master side.
- **Remote:** The site name for 'remote' Network Master side.

Test Directions Setup Select the one or more check boxes. Ethernet frames are sent from left side site name to right side site name. Ethernet frames received at the site displayed right side will be measured.

Selecting **Simultaneous in Both Directions** tests the both throughput of outgoing and incoming streams.

Communication Port

Touch the fields to set the port number.

CIR

Touch the fields to set the committed information rate (CIR).

- **Upstream CIR:** CIR of outgoing stream.
- **Downstream CIR:** CIR of incoming stream.

Test Sequence

Select the check boxes of the test defined in RFC 6349, which you wish to run.

Path MTU

Runs a test to determine the Path MTU (Maximum Transmission Unit). If cleared, set the **Upstream MTU** and **Downstream MTU**.

Baseline RTT

Runs a test to determine the Baseline RTT. If cleared, set the Baseline RTT value in the field.

Window Scan and Throughput

Runs a test to determine Throughput test while scanning the TCP window size.

Test Mode

Auto: Scans at the window size of 25%, 50%, 75%, and 100% of BDP.

Expert: Scans the window size defined by user.

Multi-Service

Runs a test to measure the throughput with multiple TCP connections.

6.10.2.2 MTU / RTT

MTU / RTT button in the navigation area is enabled if Path MTU check box or Baseline RTT check box is selected on "Control" screen.

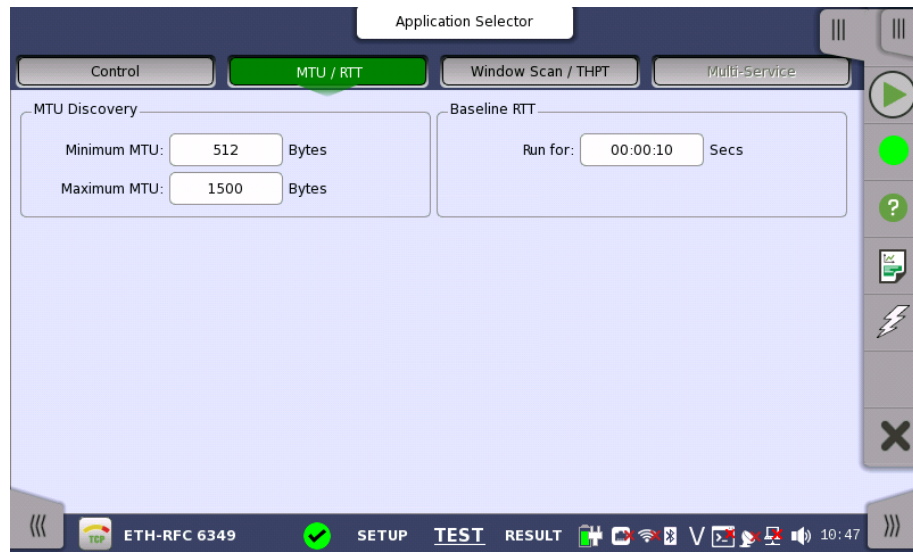

This screen allows you to specify test parameters.

MTU Discovery

The field will be enabled if Path MTU check box is selected on "Control" screen.

Touch the **Minimum MTU** or **Maximum MTU** fields set the bytes range used when discovering MTU.

Baseline RTT

The field will be enabled if Baseline RTT check box is selected on "Control" screen. Touch the fields to set the running time of the Baseline RTT test.

6.10.2.3 Windows Scan / Throughput

Windows Scan / Throughput button in the navigation area is enabled if Windows Scan and Throughput check box of Test Sequence is selected on "Control" screen.

The contents of the screen depend on the test mode selected on "Control" screen.

The arrow buttons in navigation area switch the test direction of settings. The right arrow button shows to **Local -> Remote** direction, and left arrow button shows **Remote -> Local** direction.

If **Auto** is selected on "Control" screen, following screen appears.

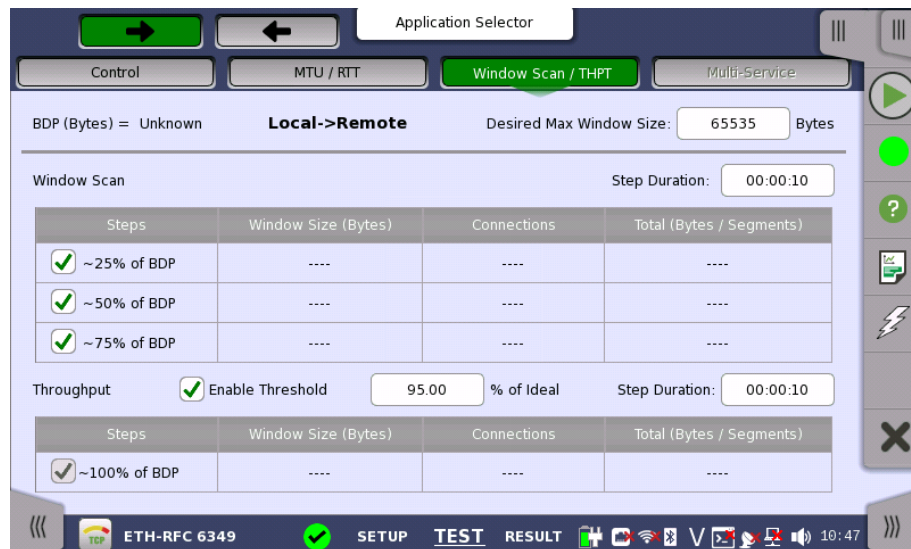

If **Expert** is selected on "Control" screen, following screen appears.



BDP (Bytes)

Appears when Test mode is set to Auto. If CIR and Baseline RTT are set on "Control" screen, calculated BDP (Bandwidth-Delay Product) appears.

Desired Max Window Size

Appears when Test mode is set to Auto. The nominal window size to be used if possible. If specified window size is lower than BDP/16, a larger window size will be calculated and used automatically.

Window Scan

Touch the **Step Duration** field to set the duration of each steps. Select the check boxes to execute the step in the table.

Auto

Test parameters are set automatically.

Expert

Window Size: Touch the field to set TCP window size.

Connections: Touch the field to set TCP connection number.

Total: Calculated bytes are displayed.

Throughput

Select the **Enable Threshold** check box if enabling the PASS/FAIL test.
 Touch the **% of Ideal** field to set the threshold of throughput.
 Touch the **Step Duration** field to set the duration of a step.

Auto

Test parameters are set automatically.

Expert

Select the check box if executing the Throughput test.
 Set the parameters as same as Window Scan.

6.10.2.4 Multi-Service

Multi-Service button in the navigation area is enabled if Multi-Service check box of Test Sequence is selected on "Control" screen.

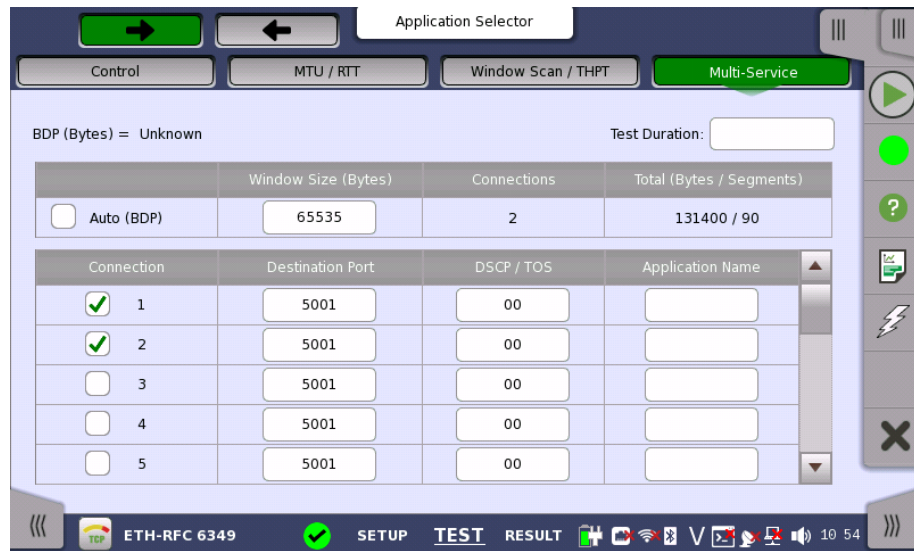

This screen allows you to set of connections by specifying TOS (Type of Service) or DSCP (differentiated Service Codepoint) used for Diffserv.
 Touch the **Test Duration** field to set the duration of Multi-service test.

Auto (BDP)

Select the check box if setting Window Size automatically. The window size is calculated from bandwidth delay product (BDP).

Connection

Select the check box of the stream number to enable a connection.

Destination Port

Touch the fields to set the destination port number.

DSCP/TOS

Touch the fields to set a Diffserv or TOS codepoint to be included in IPv4 headers belonging to the connection.

Traffic class

Touch the fields to set a Traffic class of IPv6 headers.

Flow label

Touch the fields to set a Flow label of IPv6 headers.



DSCP/TOS appears if Layer 3 in Stream Setup is set to IPv4.

Traffic class and Flow label appear if Layer 3 in Stream Setup is set to IPv6.

Application Name

Touch the fields to set a text string that identifies the application on the port number (for reporting purposes only). For example, HTTP, POP3, etc.

6.10.3 Test Results**Test Directions**

Local -> Remote



Remote -> Local



Local -> Remote of Both Directions



Remote -> Local of Both Directions

Graphical presentation

The results of the performed RFC 6349 tests can be presented in either tabular form or as graphical representations. The graphical presentation mode provides an overview of the results and the progress of the test.

6.10.3.1 Summary

When you go to the test results of the Ethernet RFC 6349 application, the following screen is displayed.

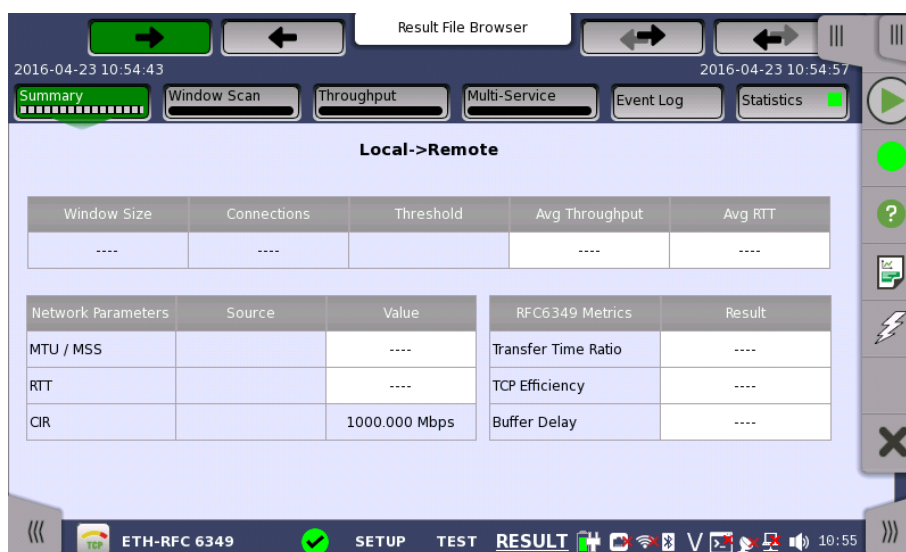

This screen presents the summary of current measurement values.

Local -> Remote: Shows the results of Upstream (Local to Remote) test.

Remote -> Local: Shows the results of Downstream (Remote to Local) test.

The measurement results are displayed in white cells.

Throughput and RTT

- **Window Size:** The window size used for the step.
- **Connections:** The number of TCP connections.
- **Threshold:** The threshold of the throughput.
- **Avg Throughput:** The average value of measured Throughputs.

- **Avg RTT:** The average value of measured RTT.

Network Parameters

- **MTU / MSS:** Maximum Transmission Unit / Maximum Segment Size
- **RTT:** Round Trip Time
- **CIR:** Committed Information Rate

RFC6349 Metrics

- [Transfer Time Ratio](#)
- [TCP Efficiency](#)
- [Buffer Delay](#)

6.10.3.2 RFC 6349 Metrics

RFC 6349 defines three metrics.

Transfer Time Ratio

Defined as below:

$$\text{TCP Transfer Time Ratio} = \frac{\text{Actual TCP Transfer Time}}{\text{Ideal TCP Transfer Time}}$$

Ideal TCP Transfer Time is calculated from bit rate, MTU and TCP payload bytes. The Maximum Transmission Unit (MTU) is obtained from Path MTU test.

TCP Efficiency

TCP Efficiency is the ratio of transmitted bytes without retransmission in transmitted total bytes. Defined as below:

$$\text{TCP Efficiency (\%)} = \frac{\text{Transmitted Bytes} - \text{Retransmitted Bytes}}{\text{Transmitted Bytes}} \times 100$$

If 100 000 bytes were sent, and 2 000 had to be retransmitted, the TCP Efficiency percentage would be calculated as:

$$\text{TCP Efficiency (\%)} = \frac{102000 - 2000}{102000} \times 100 = 98.03$$

Buffer Delay

Buffer Delay shows the ratio of increased RTT against baseline RTT. Defined as below:

$$\text{Average RTT during transfer} = \frac{\text{Total RTTs during transfer}}{\text{Transfer durations in seconds}}$$

$$\text{Buffer Delay (\%)} = \frac{\text{Average RTT during transfer} - \text{Baseline RTT}}{\text{Baseline RTT}} \times 100$$

For example, a baseline RTT of network path is 25 ms, and average RTT across the entire transfer increases to 32 ms. Buffer Delay percentage would be calculated as:

$$\text{Buffer Delay (\%)} = \frac{32 - 25}{25} \times 100 = 28$$

6.10.3.3 Window Scan

Touching the **Window Scan** button in the navigation area will display the screen shown below.



This screen presents the results from the Window Scan test. The ideal throughput and the actual throughput are shown in the chart. If touching on the Graph bars, step details appear in the right hand table.

6.10.3.4 Throughput

Touching the **Throughput** button in the navigation area will display the screen shown below.



This screen presents the Throughput results in graph or table. Touch the **Graph** and **Table** buttons to switch between the tabular form and a graphical presentation of the results.

The ideal throughput, RTT and [TCP Efficiency](#) are shown in the graphical presentation.

- THPT/EFF: Throughput and TCP Efficiency
- THPT/RTT: Throughput and Round Trip Time

Following results are displayed in the tabular form.

- Avg Throughput
- Ideal Throughput
- Actual Transfer Time
- Ideal Transfer Time
- Transfer Time Ratio
- Window Size / Conn
- Transmitted Bytes
- Retransmitted Bytes
- Retransmitted %
- TCP Efficiency

- Baseline RTT
- Min RTT
- Avg RTT
- Max RTT
- Buffer Delay

In bidirectional mode, the measured throughput in bidirectional mode is less than the ideal in one way mode. This is due to the overhead caused by interleaving returning ACK frames into the transfer. The ideal throughput of the instrument in bidirectional mode is calculated by considering the estimated interleaving returning ACK frame.

In case of connecting iPerf server, the "Interval" result of iPerf server is displayed more 1 second than the "Actual Transfer Time" result of the instrument. When you check the result of iPerf server, it is recommended to set the duration of the test by sufficient long period.

6.10.3.5 Multi-Service

Touching the **Multi-Service** button in the navigation area will display the screen shown below.



This screen presents results by each TCP connection of RTT, Throughput and [TCP Efficiency](#). Use the **Graph** and **Table** buttons to switch between the tabular form and a graphical presentation of the results.

Touching the button in navigation area switches the Test direction of results.

The results in Connection are:

- **Connection**: Connection number of the stream
- **Min RTT**: Minimum Round Trip Time
- **Avg RTT**: Average Round Trip Time
- **Max RTT**: Maximum Round Trip Time
- **Tx THPT**: Transmitter throughput
- **TCP Efficiency**: The ratio of actual throughput against ideal throughput

The results in Total are:

- **Min RTT**: Minimum RTT in all connections
- **Avg RTT**: Average Round Trip Time
- **Max RTT**: Maximum RTT in all connections
- **Tx THPT**: Sum of throughput in each connections
- **TCP Efficiency**: The ratio of total actual throughput of connections against total ideal throughput of connections

6.10.3.6 Event Log

Touching the **Event Log** button in the navigation area displays the screen providing the event log data. Refer to [Event Log](#) of SDH/SONET/PDH/DSn BERT application.

6.10.3.7 Statistics

Touching the **Statistics** button in the navigation area displays the screen providing the statistics data.

Refer to [Statistics](#) of BERT for the operation.

Performance and **Frame** are displayed as RFC 6349 Statistic result.

6.11 SAT 1564



Service Activation Test is an out-of-service test used to assess the proper configuration and performance of Ethernet services. The test methodology, which is described in the ITU-T recommendation Y.1564, applies to point-to-point and point-to-multipoint connectivity in the Ethernet layer and to the network portions that provide (or contribute to) the provisioning of such services.

The recommendation also defines the terms used in the Network Master screens related to Service Activation Test.

ITU-T Y.1564 is designed around three key objectives:

- To serve as a network *service level agreement* (SLA) validation tool, ensuring that a service meets its guaranteed performance settings in a controlled test time.
- To ensure that all services carried by the network meet their SLA objectives at their maximum committed rate, proving that under maximum load network devices and paths can support all the traffic as designed.
- To perform medium- and long-term service testing, confirming that network elements can properly carry all services while under stress during a soaking period.

6.11.1 Ports Setup and Status

The first step in running an application is to set up the port interfaces. This is done on the **Ports Setup** screen, which also provides port status information.

The setup options and status information related to the Ethernet interface are described in a separate section:

- [Ethernet Setup and Status](#)

For applications also including an OTN interface, you can find a description of the setup options and status information for OTN in the following section:

- [OTN Setup and Status](#)

Please refer to the sections relevant for your current port setup requirements.

6.11.2 Test Setup

6.11.2.1 Control

When you go to the test setup of the SAT 1564 application, the following screen is displayed.

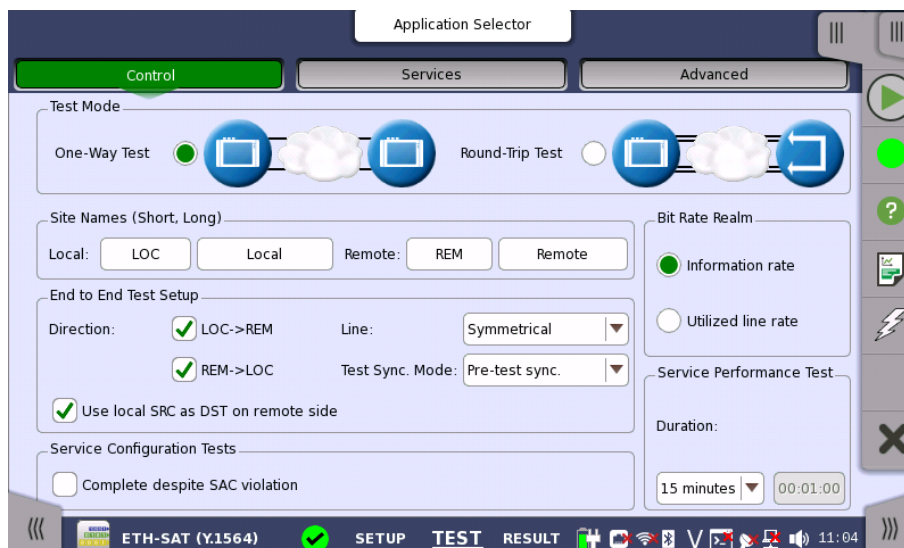

This screen allows you to configure the test mode and other general parameters related to a [Service Activation Test](#).

Test Mode

Use the radio buttons to select the relevant test mode.

One-Way Test

In this test mode, two Network Master units will work together performing the test (End to End Test). The Network Master which users actually operate to perform SAT Y.1564 test is the *Local* and the other Network Master which sends and receives Ethernet frames via the network under test is the *Remote*.

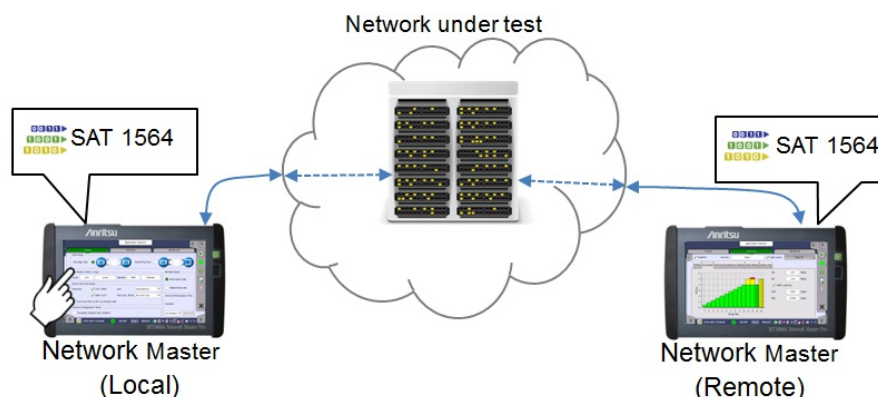

After starting SAT Y.1564 test, the 'local' Network Master tries to control the 'remote' Network Master via the network under test. To control the 'remote' Network Master, the 'local' Network Master starts communication using Dest. MAC address and Dest. IP address set on the Stream screen. Therefore, destination addresses of the 'local' Network Master and source addresses of the 'remote' Network Master should be set to the same. Also, enable **Accept Network Master Configuration frames** option on [Incoming Frames](#) tab of the Setting screen on the 'remote' Network Master.

The required setup to perform SAT Y.1564 test is transferred from the 'local' Network Master to the 'remote' Network Master when the test is started.



Enable "Compatible configuration frames with CMA3000 and V2.X or older" to support communication with CMA3000 and Network Master V2.X or older. The setting is locate under Ports Setup screen > Ethernet > Settings.



Frames from Service 1 on the local side must reach Service 1 on the remote side and vice versa. This applies to all services.

When the End to End test is started, a popup will appear on the remote side, telling that the unit is being remotely controlled and allowing the user to break the connection, if required. The popup will disappear when the test is completed or stopped on the local side.

When the End to End test is completed, the test results are transferred from the remote side to the local side.

Round-Trip Test

This test mode is used when testing network by reflecting traffic back to the instrument. This requires a device to reflect the traffic back, for instance a second Network Master.



A remote side Network Master in Reflector mode must have Swap IP address and Swap Ports on UDP and TCP frames enabled.

Site Names (Short, Long)

Touch the fields to set the Site Names :

- **Local:** The site name for 'local' Network Master side.
- **Remote:** The site name for 'remote' Network Master side.

End to End Test Setup This setup is enabled when **One-Way Test** is selected.

Direction

Use the check boxes to specify which directions to test. Ethernet frames are sent from left side site name to right side site name. Ethernet frames received at right site will be measured.

Line

Use the drop-down menu to select how the service attributes for the directions are set up.

- **Symmetrical:** The same service attributes are used for both directions.
- **Asymmetrical:** Service attributes are set up for each direction.

Test Sync. Mode

Use the drop-down menu to select the method for synchronization of the two instruments performing the test. Synchronization is required for correct measurement of FTD and FDV in End to End Test mode.

- Select **GPS** if external GPS receivers are available at both the local and the remote site. This gives the most accurate measurements.
- Select **Pre-test sync.** if GPS is not available for both instruments. In this mode, synchronization is obtained using proprietary protocol prior to the first step of the Service Configuration Test.



External GPS sensor is available from Anritsu (part no. G0325A or MU100090A).

Use local SRC as DST on remote side

Select this to transfer the local source IP address to the remote side, to be used as destination IP address. If ARP is enabled locally, it will also be enabled on the remote side. If IP is disabled, the local source MAC address will be transferred to the remote side, to be used as destination MAC address.

Bit Rate Realm

The CIR/EIR rates for services refer to either information rate or utilized line rate. Use the radio buttons to specify which bit realm to operate in.

Information rate

The bit rate of frames starting with the first MAC address bit and ending with the last FCS bit.

In this realm actual load on the Ethernet line is bigger as minimum inter frame gap, preamble, and start of frame delimiter (20 octets in total per frame) are not included. Maximum possible value depends on selected framesize(s).

For instance, a 100 Mbit/s Ethernet port can handle a total information rate of about 77 Mbit/s to 99 Mbit/s depending on the average frame size of the transmitted Ethernet frames.

Utilized line rate

The bit rate of the Ethernet line, including the bits for:

- The minimum inter frame gap
- Preamble
- Start of frame delimiter
- Frame starting with the first MAC address bit and ending with the last FCS bit.

In this realm the Ethernet line rate defines the maximum combined CIR rate for all included services.

Service Configuration Tests

Complete despite SAC violation

Select this check box to allow the configuration test to be completed despite any detected SAC violations. If not selected, the configuration test will stop when the first SAC violation is detected.

Service Performance Test

Duration

Allows you to set the duration period of the performance test. Either select one of the predefined values in the drop-down menu or use the field to specify a custom period.

6.11.2.2 Services

Touching the **Services** button in the navigation area will launch the screen shown below.

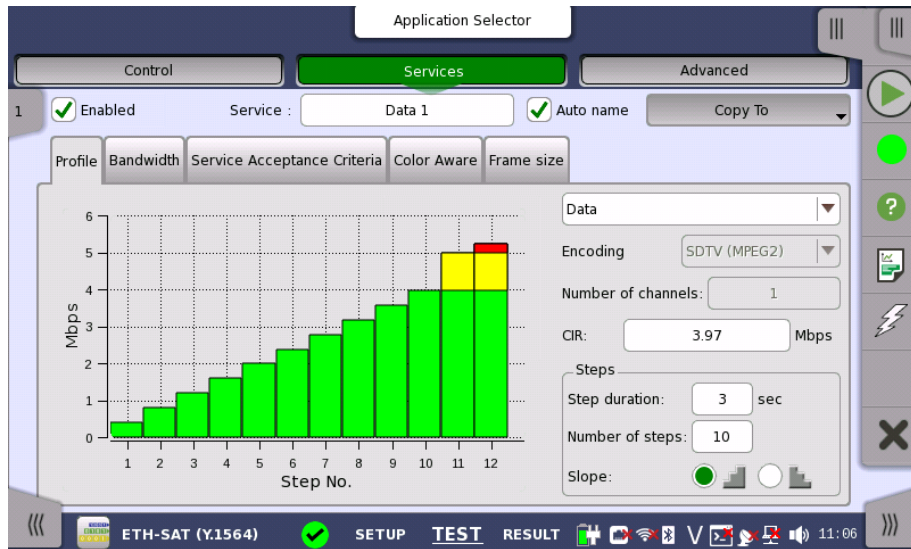

If the End to End test setup on the 'Control' screen has been set to asymmetrical service attributes setups, two Services buttons are displayed instead of one: Services L->R button and Services R->L button.

This screen allows you to configure up to eight services being tested in the current [Service Activation Test](#). For each service, you can:

- [Enable/Disable the service](#)
- [Set up the profile](#)
- [Set up the bandwidth](#)
- [Set up the service acceptance criteria \(thresholds\)](#)
- [Set up the color aware](#)
- [Set up the frame size configuration](#)

Enable/Disable service

Select the services that are to be tested. Up to 8 services can be specified, either by enabling already defined services or by defining new ones. Use the stream slide-out to select the relevant services. The stream slide-out is displayed via the tab in the top left-hand corner of the setup area.

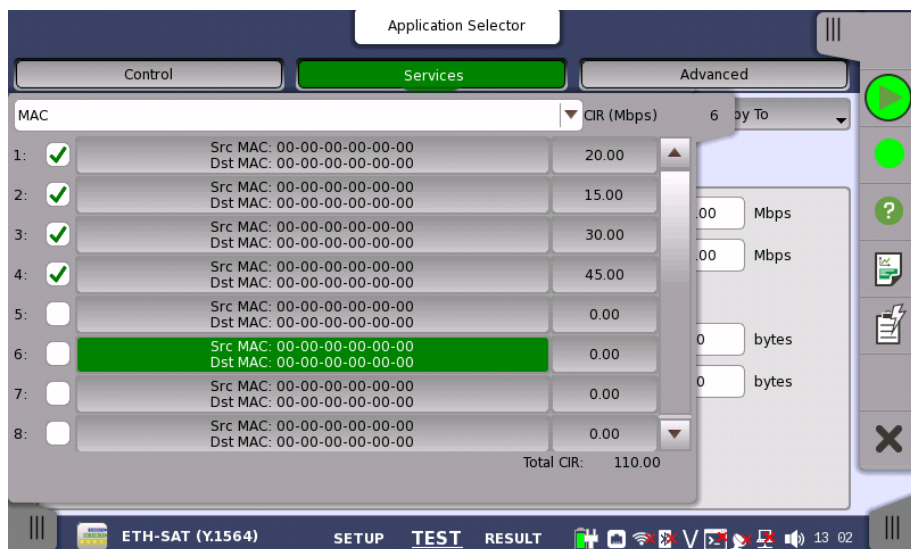

Use the **Enabled** check box to enable/disable the service specified in the **Service** field.

To define a new service, select the relevant stream, specify a name in the **Service** field and then configure the service using the tab pages.

Profile tab

The **Profile** tab page contains the following parameters:

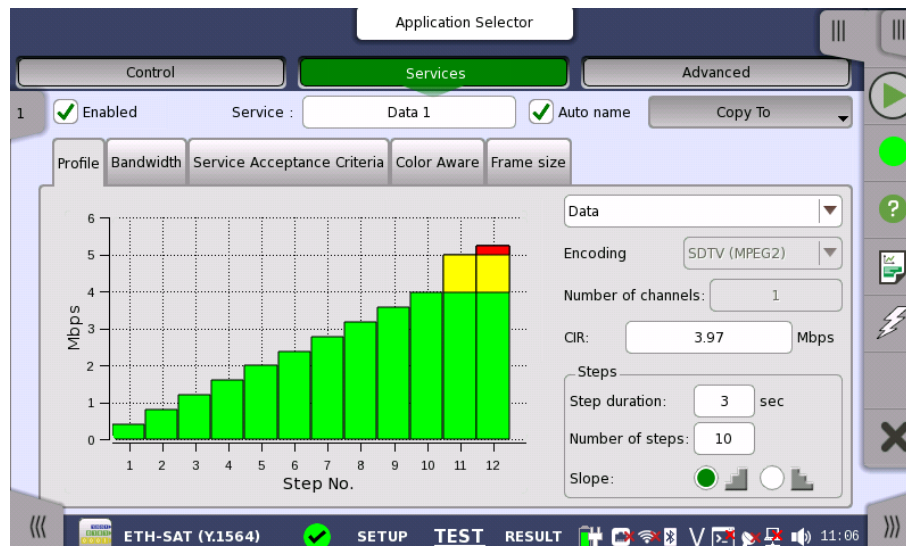

Profile

In case of Round-Trip Test mode, the drop-down menu at the top allows you to select the service profile as either **Data**, **Video** or **Voice**.

Encoding

Open the drop-down menu to select the relevant encoding type. The available values depend on the selected profile type.

Number of channels

Specify the number of channels.

CIR

Allows you to specify the Committed Information Rate (CIR). When set to zero, the CIR test is excluded. If color awareness is enabled (see below), this is the bit rate for green frames.

Steps

Step duration

Allows you to specify the test step duration. Valid setting is from 1 to 60 seconds.

Number of steps

Allows you to specify the number of steps in the CIR test. Valid setting is from 1 to 10 steps.

Slope

Use the radio buttons to select an *ascending* or *descending* test slope for the CIR test.

- If the *descending* test slope is selected in *round-trip* test mode, all remaining CIR steps are skipped when a CIR step passes.
- In *one-way* test mode, all CIR steps are always performed.

Bandwidth tab

The **Bandwidth** tab page contains the following parameters:

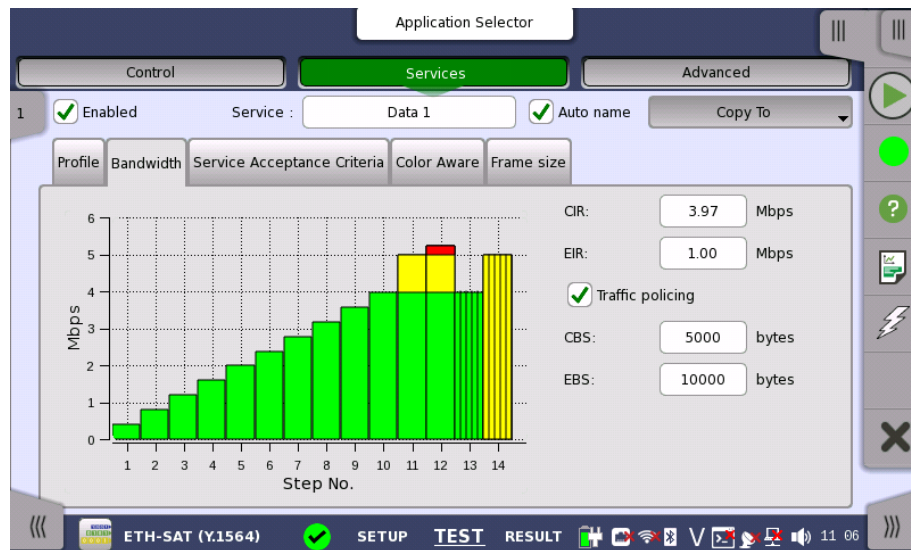

CIR

Allows you to specify the Committed Information Rate (CIR). When set to zero, the CIR test is excluded. If color awareness is enabled (see below), this is the bit rate for green frames.

EIR

Allows you to specify the Excess Information Rate (EIR). When set to zero, the EIR test is excluded. If color awareness is enabled (see below), this is the bit rate for yellow frames.



CIR plus EIR for a service must be greater than zero.

Traffic policing

Select this check box to enable the traffic policing test. When enabled, you can specify a margin on the **Service Acceptance Criteria** tab page and use that margin for pass/fail evaluation during the service configuration test. The test will fail if the throughput is greater than CIR + EIR + Margin.

CBS

Allows you to specify the Committed Burst Size (CBS) in bytes. When set to zero, the CBS test is excluded. If color awareness is enabled (see below), this is the burst size for green frames.



The CBS test can only be executed if CIR is also greater than zero. Furthermore, it must be possible to send at least twice the number of CBS bytes with CIR rate within the step duration.

EBS

Allows you to specify the Excess Burst Size (EBS) in bytes. When set to zero, the EBS test is excluded. If color awareness is enabled (see below), this is the burst size for yellow frames.



The EBS test can only be executed if EIR is greater than zero. If CIR is greater than zero, the EBS test also requires that CBS is greater than zero. Furthermore, it must be possible to send at least twice the number of EBS bytes with EIR rate within the step duration.

Service Acceptance Criteria tab

The Service Acceptance Criteria tab page contains the following parameters:

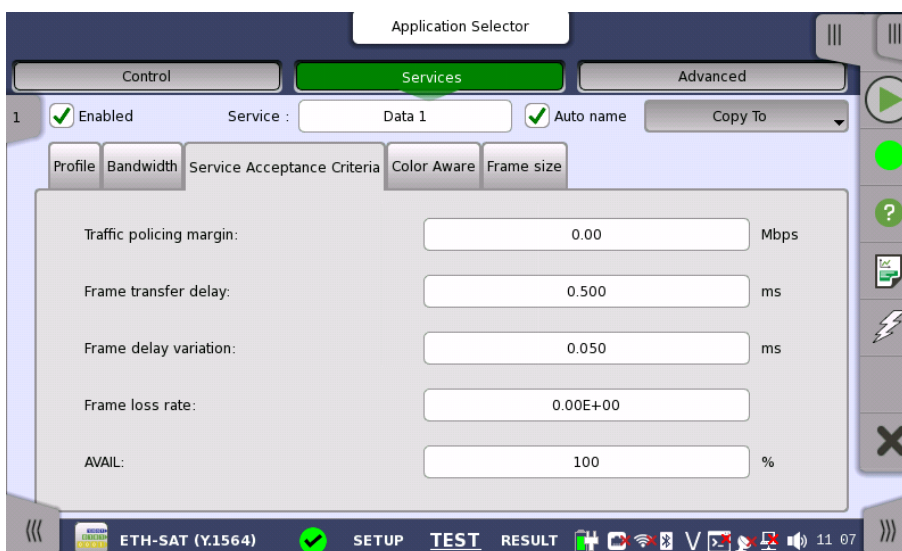

Traffic policing margin

Only active when the traffic policing test is enabled. Allows you to specify a margin for the pass/fail evaluation during the service configuration test. The test will fail if the throughput is greater than CIR + EIR + Margin.

Frame transfer delay / RT Frame transfer delay

Allows you to specify the maximum acceptable transfer delay in ms (mean).

Frame delay variation / RT Frame delay variation

Allows you to specify the maximum acceptable frame transfer deviation in ms (mean).

Frame loss rate

Allows you to specify the maximum acceptable frame loss rate.

AVAIL

Allows you to specify the minimum acceptable availability percentage.

Color Aware tab

The Color Aware tab page contains the following parameters:

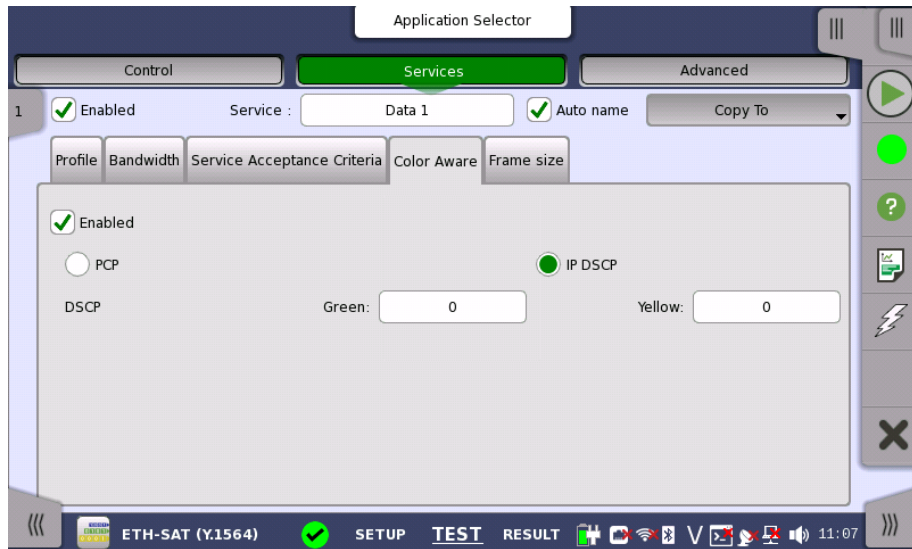

Select the **Enabled** check box to enable color awareness. You can then choose the color method (**PCP** or **IP DSCP**), as well as the priority values to mark the green and yellow frames with.

- Choose **PCP** to use VLAN priority coloring. This requires that VLAN is enabled.
- Choose **IP DSCP** to use IP priority coloring.

With color awareness enabled, the test will include results for green and yellow frames for the EIR, Traffic Policing and the EBS tests.



With color awareness, the transmitted frame rate is 100% CIR green-marked frames plus 125% EIR yellow-marked frames. If EIR is less than 20% of CIR, the transmit rate is 100% CIR green-marked frames plus 25% CIR yellow-marked frames plus 100% EIR yellow-marked frames. Without color awareness, the transmit rate is 100% CIR + 125% EIR. If EIR is less than 20% of CIR, the transmit rate is 125% CIR + 100% EIR.

Frame Size tab

The contents of the **Frame Size** tab page depends on your choice of mode. Frame size has two modes: *Constant* and *EMIX*.

Constant

Allows you to either select a constant frame size from one of several predefined sizes, or to define a custom frame size with MTU or User defined setting.

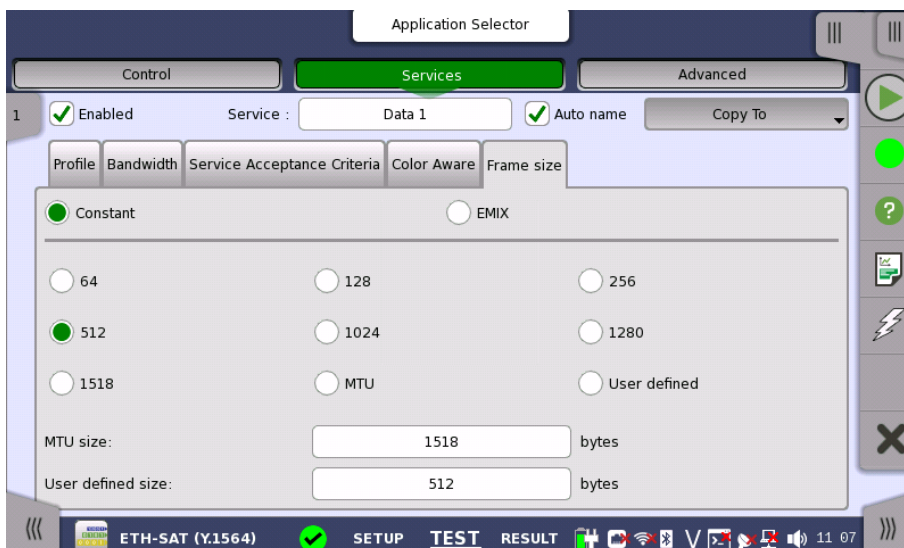

EMIX

Allows you to set up a repeating frame size pattern. The pattern must consist of at least 1 frame size and at most 16.

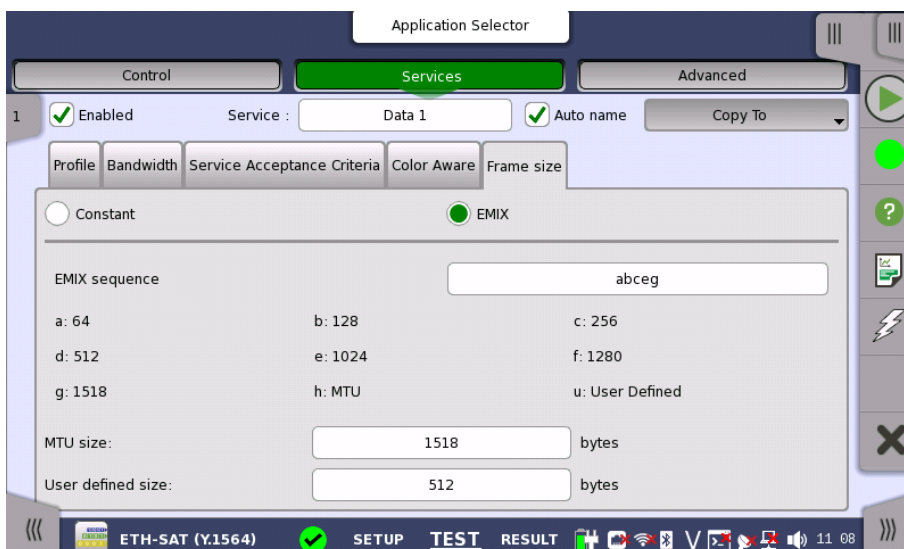

Touching **EMIX sequence** field opens the dialog box.

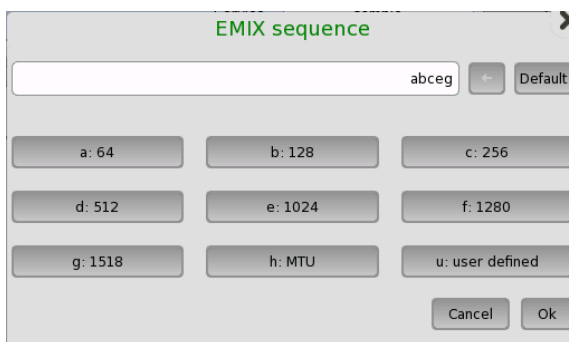

Frame size is protocol headers and payload combined. Frame size does not include preamble and interframe gap.

6.11.2.3 Advanced

Include addresses in frame filter on receiver

When enabling this function, the Ethernet frames which their destination addresses match to following items will appear on the [Streams](#) screen.

- Src MAC
- Src IP
- VLAN ID
- Src Port

This setting makes the effect to only following measurement results on the Statistics screen.

- Multi Stream Transmit
- Multi Stream Throughput
- Multi Stream Frame Loss
- Multi Stream Latency
- Multi Stream Jitter

This setting does not effect to [Frame Capture](#).

6.11.3 Test Results

6.11.3.1 Summary

When you go to the test results of the Service Activation Test, the following screen is displayed.

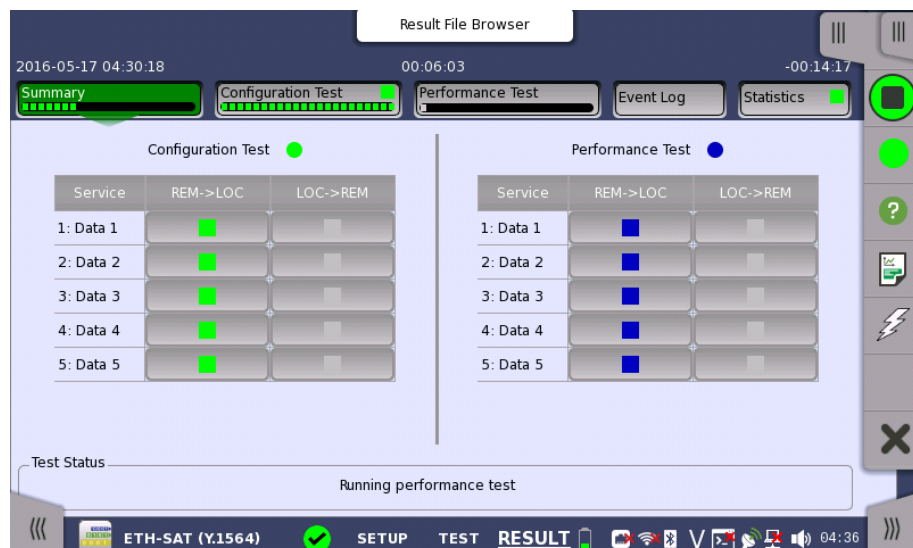

This screen presents a summary of the results of the Service Activation Test. Touching the result button for a specific service in either the **Configuration Test** or **Performance Test** result panel will display the relevant screen with detailed results information.

Item status Lamp

Each result item has a colored Lamp indicating the status for this item and its sub items:



- Green The item and all its sub items are passing or have passed the Service Acceptance Criteria.
- Yellow The GPS synchronization has been lost for a following period or more.
 - G0325A: 10 seconds
 - MU100090A: 1 hour

FTD and FDV results could be compromised if the duration of continuous GPS synchronization loss has been longer the this time FTD and FDV results are compromised.
- Red The items and one or more of its sub items have failed the Service Acceptance Criteria.
- Gray Results for the item are pending.
- Blue The measurement is running.

GPS status Lamp

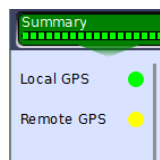

When Test Sync. Mode is set to **GPS** on Control screen, status for the GPS time synchronization is displayed at the top of the screen with colored Lamps - one Lamp for the local side and one for the remote side.

- Green GPS synchronization is OK.
- Yellow GPS synchronization has been lost for 10 seconds (1 hour for MU100090A) or more. FTD and FDV results could be compromised.

6.11.3.2 Configuration Test

Touching the **Configuration Test** button in the navigation area will display the screen shown below.

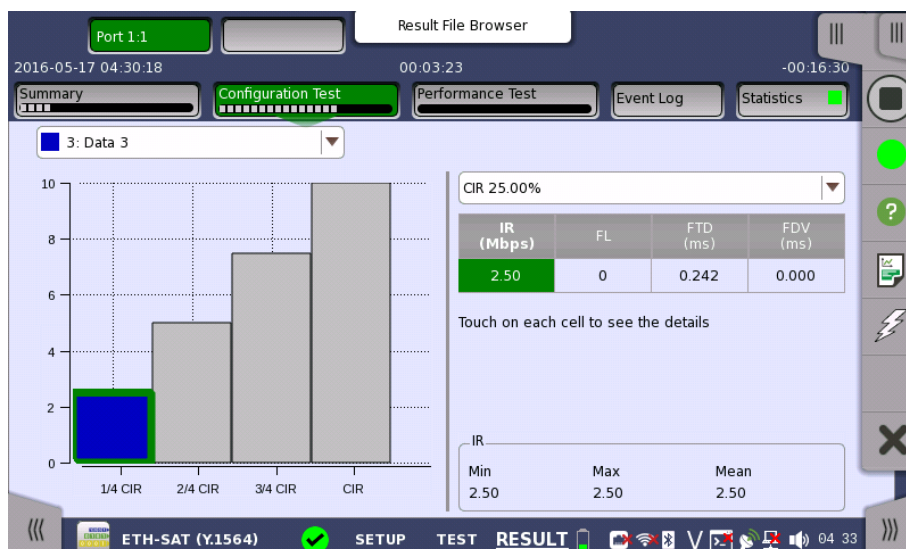

This screen presents the detailed Configuration Test results for a specific service. Use the drop-down menu at the top of the screen to select which service to view.

The results are presented in a table and are related to a specific CIR% (CIR 25.00%, CIR 50.00%, CIR 75.00%, and CIR 100%). Select the relevant CIR% either by selecting the corresponding bar in the bar graph or by using the CIR drop-down menu.

Touching a cell in table displays Minimum, Maximum, Mean value and the Threshold, at bottom of screen.

Test results

Select a cell in the results table to see the details. The following information is presented:

IR / ULR

Shows the minimum, mean and maximum bit rate in Mbps. Depending on the test setup, the bit rate is either Information Rate (IR) or Utilized Line Rate (ULR).

FL

Shows the number of lost frames and the frame loss ratio. The frame loss ratio is frames lost divided by frames transmitted.

FTD / RT FTD

Shows the minimum, mean, maximum and current Frame Transfer Delay in milliseconds. Depending on the test setup, the result is either one-way delay or round-trip delay.

FDV / RT FDV

Shows the minimum, mean, maximum and current Frame Delay Variation in milliseconds. Depending on the test setup, the result is either one-way or round-trip.

6.11.3.3 Performance Test

Selecting the **Performance Test** button in the navigation area will display the screen shown below.



This screen presents the detailed Performance Test results.

Test results

Select a cell in the results table to see the details. The following information is presented:

IR

Shows the minimum, mean and maximum bit rate in Mbps. Depending on the test setup, the bit rate is either Information Rate (IR).

FL

Shows the number of lost frames and the frame loss ratio. The frame loss ratio is frames lost divided by frames transmitted.

FTD

Shows the minimum, mean, maximum and current Frame Transfer Delay in milliseconds. Depending on the test setup, the result is either one-way delay or round-trip delay.

FDV

Shows the minimum, mean, maximum and current Frame Delay Variation in milliseconds. Depending on the test setup, the result is either one-way or round-trip.

Avail

Shows *Availability*, which is the percentage of one-second in intervals that are categorized as available. An available second occurs when the line is in the available state. The available state begins at the onset of 10 consecutive non-SES_{eth} outcomes. A SES_{eth} is defined as a second with a frame loss rate of 0.5 or more. See ITU-T Y.1563 *Ethernet frame transfer and availability performance* clause 9.

6.11.3.4 Event Log

Touching the **Event Log** button in the navigation area displays the screen providing the event log data. Refer to [Event Log](#) of SDH/SONET/PDH/DSn BERT application.

6.11.3.5 Statistics

Touching the **Statistics** button in the navigation area displays the screen providing the statistics data. Refer to [Statistics](#) of Mon/Gen for the operation.

6.12 Traceroute



The Traceroute test is used to determine the route taken by packets in an IP network. The intermediate routers traversed are identified by the sending of a sequence of ICMP Ping packets to the desired destination, each packet with a too low Time-to-Live (TTL) or *hop limit* so that it terminates in one of the routers and makes the router return an error message. Routers decrement the TTL and discard a package when the TTL value has reached zero.

Traceroute works by gradually increasing the TTL value for each packet, starting at "1". The first set of packets terminates at the first router, the second set at the second router, and so on until a ping reply is received from the destination. This is used to build a list of the hosts that the packets must pass through to reach the intended destination.

The test will send regular ICMP type 11 Ping packets to each host that is detected in this way, and display the resulting RTT (Round Trip Times).

6.12.1 Ports Setup and Status

The first step in running an application is to set up the port interfaces. This is done on the **Ports Setup** screen, which also provides port status information.

The setup options and status information related to the Ethernet interface are described in a separate section:

- [Ethernet Setup and Status](#)

6.12.2 Test Setup

When you go to the test setup of the Ethernet Traceroute test, the following screen is displayed.

The screenshot shows the 'Test Setup' screen for an Ethernet Traceroute test. The interface includes a 'Port 1' button and an 'Application Selector' dropdown at the top. The main configuration area is divided into two sections: 'Test Duration' and 'Threshold'. Under 'Test Duration', there are three input fields: 'Number of attempts' (3), 'Max number of hops' (30), and 'Ping each hosts' (3) times. Under 'Threshold', there is one input field: 'Timeout' (500) ms. On the right side, there is a vertical toolbar with icons for play, help, print, and close. At the bottom, there is a status bar with 'ETH-Traceroute', a green checkmark, and tabs for 'SETUP', 'TEST', and 'RESULT'. The time is 16:52.

This screen allows you to configure the parameters related to a [Traceroute](#) test.

Test Duration

Number of attempts

Used to specify the maximum number of times that Ping packets with each TTL value are transmitted. If no ICMP type 11 or ping reply is received after this number of attempts, the test will move on to a higher TTL value.

Max number of hops

Used to specify the maximum number of hops performed in the test. The test will gradually increment the TTL value until a regular ping reply is received. If no ping reply is received before this number of hops, the test will stop.

Ping each hosts

Used to specify the number of times each host is pinged to determine the RTT. For each hop that responds with ICMP 11 type packets, and for the desired destination, this number of Ping packets is sent.

Threshold

Timeout

Used to specify the timeout limit for Ping packets sent by the test.

6.12.3 Test Results

6.12.3.1 Summary

When you go to the test results of the Ethernet Traceroute test, the following screen is displayed.

Hop	Host	Min Ping (ms)	Max Ping (ms)	Avg Ping (ms)	T
1	<timeout>	--	--	--	--
2	<timeout>	--	--	--	--
3	<timeout>	--	--	--	--
4	<timeout>	--	--	--	--
5	<timeout>	--	--	--	--
6	<timeout>	--	--	--	--
7	<timeout>	--	--	--	--
8	<timeout>	--	--	--	--
9	<timeout>	--	--	--	--

This screen shows the status/results of a running Traceroute test, or the results of the most recently completed test.

Each row in the table represents a hop in the chain of host servers of the traceroute. For each hop/host the following information is shown:

- The IP address of the host
- The Min., Max. and Average ping RTTs
- The number of ping timeouts during the determination of the RTT



In the results table for a successfully completed test, the last row will represent the destination of the traceroute.

6.12.3.2 IEEE1588v2 Log

If **Ext. log** is selected in IEEE1588v2 screen of Ethernet Frame Setup, the **IEEE1588v2 Log** button appears in the navigation area. Refer to [IEEE1588v2 Log](#) in "BERT" for the operation.

6.12.3.3 Event Log

Touching the **Event Log** button in the navigation area displays the screen providing the event log data. Refer to [Event Log](#) of SDH/SONET/PDH/DSn BERT application.

6.12.3.4 Statistics

Touching the **Statistics** button in the navigation area displays the screen providing the statistics data. Refer to [Statistics](#) of BERT for the operation.

6.13 Sync Test



Sync Test application provides One Pulse Per Second (1PPS) measurement and One Way Delay (OWD) / Packet Time error (Packet TE) measurement.

- 1PPS measurement measures phase difference between the 1PPS signal under test and the reference 1PPS signal.
- In OWD and Packet TE measurement, PTP packet time is compared to reference 1PPS signal to measure OWD and packet TE.

Ground Master Clock, Boundary Clock, etc will be assumed as the device under test.



To perform Sync Test application, the MT1000A-005 and the MU100090A are necessary.

Using the MU100090A allows you to perform 1PPS comparison and OWD measurement based on GPS signal.

The connection between the MU100090A connectors and MT1000A connectors are described in the following section:

[GPS Disciplined Oscillator Interfaces](#)

Click the GPS icon (📶) on Status bar, and set Sync. Mode to GPS. When selecting **1PPS sync in**, the clock accuracy of Network Master is not guaranteed.

A connection example between the DUT and the Network Master is shown below.

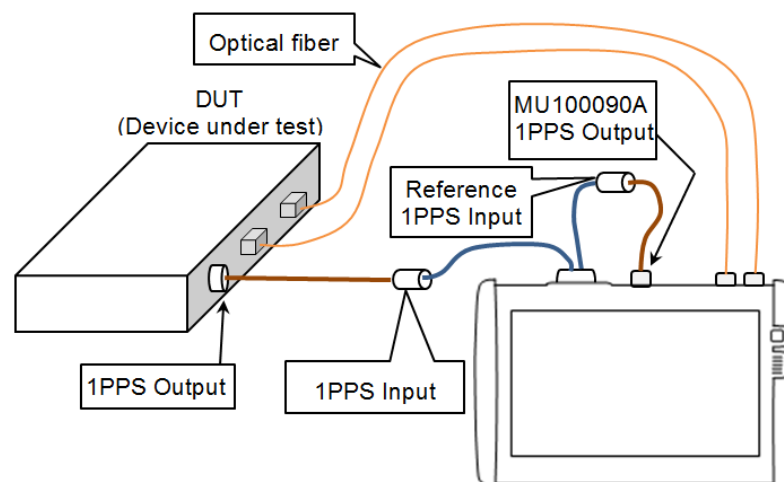

Connection Example of Sync Test

1PPS Measurement

Measures Phase error, Deviation, and Filtered TE from 1PPS signals which are input to two BNC connectors of AUX conversion adaptor.

Phase error is a time difference between Reference 1PPS and 1PPS signal under test. The value is positive if 1PPS signal under test is advanced from Reference 1PPS. The value is negative if 1PPS signal under test is delayed from Reference 1PPS.

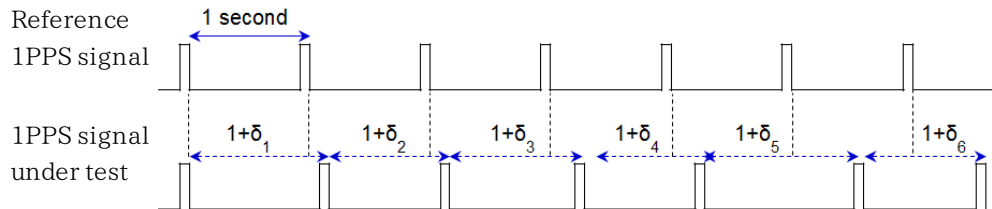
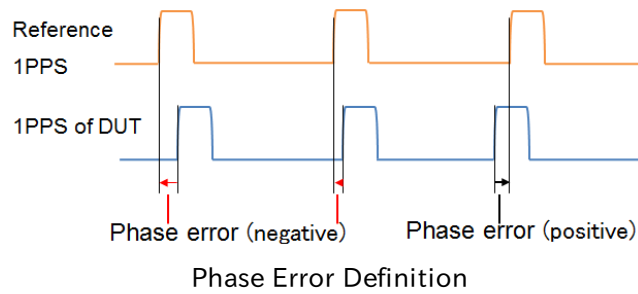

Measurement Result Example

n	1	2	3	4	5	6
δ_n	0.1	0	0.05	0	0.2	0
Deviation	0.1	0	0.05	0	0.2	0
Phase error	-0.1	-0.1	-0.15	-0.15	-0.35	-0.35

The difference between two BNC cable lengths makes time difference of 1PPS signals. Therefore it affects the phase error measurement result. You can set the correction of the time difference caused from the cable length difference at **1PPS cable correction** in the Control screen.

Filtered TE displays the phase error passed through the 0.1 Hz bandwidth low pass filter. The phase error is displayed with suppressed noise.

OWD and Packet TE Measurement

This part explains how to measure the OWD and Packet TE. To perform the OWD Measurement, select both of **Enable IEEE1588v2** and **Slave mode** on the [IEEE 1588v2](#) screen.

1. DUT (Device Under Test) sends *Sync* message to Network Master. T_1 is the timestamp of DUT at the time *Sync* message has been sent. When not using *Follow_Up* message, T_1 is notified to Network Master by *Sync* message.
2. τ_2 is the timestamp of Network Master at the time *Sync* message has arrived.
3. If using *Follow_Up* message, T_1 is notified to Network Master by *Follow_Up* message.
4. Network Master sends *Delay_Request* message to DUT. τ_3 is the timestamp of Network Master at the time *Delay_Request* message has been sent.
5. T_4 is the timestamp of DUT at the time *Delay_Request* message has arrived.
6. Master clock sends *Delay_Response* message and notifies T_4 to Network Master.

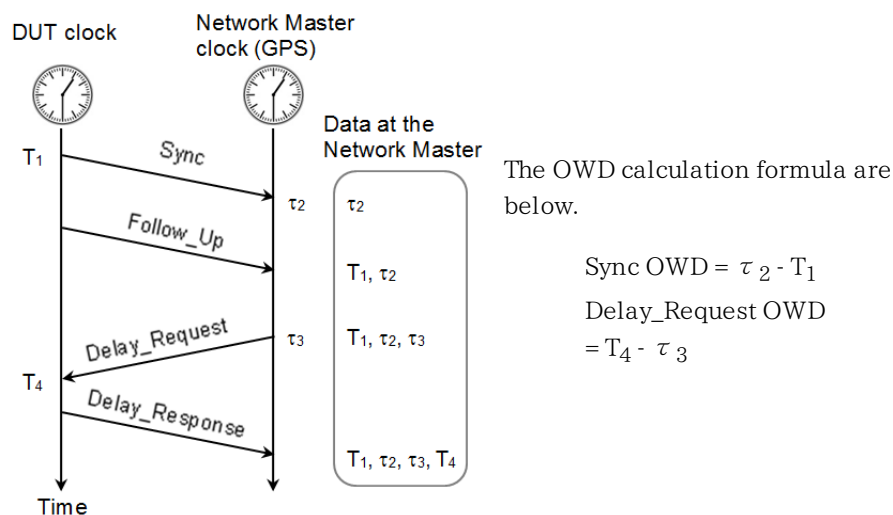

$$\text{Sync OWD} = \tau_2 - T_1$$

$$\begin{aligned} \text{Delay_Request OWD} \\ = T_4 - \tau_3 \end{aligned}$$

OWD contains the delay of the optical fiber cable between DUT and Network Master. To calculate Packet TE (TE1, TE4, Terr), TEs (Time error) that the cable delay is subtracted from OWD are defined as:

- $TE1 = -1 \times (\text{Sync OWD}) + \Delta ms$
 Δms : The cable delay in direction from DUT (master) to Network Master (slave).
- $TE4 = (\text{Delay_Request OWD}) - \Delta sm$
 Δsm : The cable delay from Network Master (slave) to DUT (master).
- $Terr = (TE1 + TE4)/2$

$\Delta ms = \Delta sm$ is assumed in Packet TE Measurement. This value can be set at **Ethernet cable correction** in Control screen.

6.13.1 Ports Setup and Status

The first step in running an application is to set up the port interfaces. This is done on the **Ports Setup** screen, which also provides port status information.

The setup options and status information related to the Ethernet interface are described in a separate section:

- [Ethernet Setup and Status](#)

In the Ethernet setting of Sync Test, five buttons appear in the Navigation Area. Settings in the pages are not common between Port 1 and Port 2.

- [Port](#)
- [Settings](#)
- [SyncE](#)
- [IEEE 1588v2](#)
- [OAM](#)

To measure OWD, it is necessary to set IEEE 1588v2 to enable and set to Slave mode.

Select the use of Follow_Up message by **Step mode** in IEEE 1588v2.

- One-step: Does not use the Follow_Up message.
- Two-step: Uses the Follow_Up message.

6.13.2 Test Setup

6.13.2.1 Control

Touching the **Control** button in the navigation area displays the following screen.

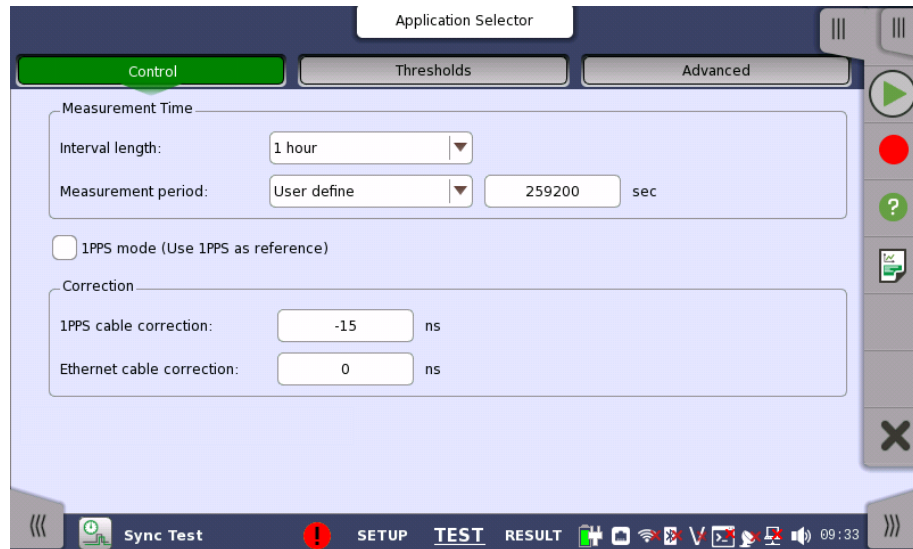

Measurement Time

Interval length

Refer to "[Control](#)" in BERT Test Setup subsection for the operation.

Measurement period

Allows you to set the time from the measurement start to the stop. Following values are listed in the pull-down menu.

100 sec, 1000 sec, User define

Selecting **User define** allows users to enter the measurement period.

When selecting **User define**, the 1PPS and TE results are output to a CSV file(s) every second during the measurement. This function allows you to save all graph data, even when performing the measurement for a long time. Once the measurement has started, the date and time of the measurement start appears next to the measurement time setup field.

1PPS mode (Use 1PPS as reference)

Selecting the check box displays OWD and Packet TE in the drift value within ± 500 ms, not in the absolute values. Calculation method is below:

1. Divide the absolute value by 1000 ms to find the remainder.
2. If the remainder exceeds 500 ms, subtract 1000 ms.
3. If the original value is negative, multiply the remainder by -1.

Packet TE Result Display Example

Unselected	Selected
2200 ms	200 ms
1650 ms	-350 ms
-900 ms	100 ms



When using MU100090A without GPS, internal ToD (time of date) is used for TE measurement. In this case, in spite of accurate synchronization below 1.0 second, the ToD is not accurate to UTC over 1.0 second. To ignore the range over 1.0 second for TE testing, select the check box. As the result, relative display of TE will be within ± 500 ms.

Correction

1 PPS cable correction

Allows to set a correction value of the delay time in ns unit that is caused by difference of 1PPS cable length.

In the measured phase error value, the phase error and the cable delay are included.

The cable delay is caused by difference of cable length between **Reference 1PPS Input** and **1PPS Input**.

To measure the phase error precisely, set the correction value to **1PPS cable correction**.

When calculating the delay time from the cable length, it is recommendable to use 5 ns/m as the conversion factor.

If the cable length of **1PPS Input** is longer than the **Reference 1PPS Input**, set a negative number as the correction value.

Phase error is calculated by the measured phase error and **1PPS correction value**.

Other result parameters such as **cTE**(constant Time Error) are calculated by using the phase error after correction.

Ethernet cable correction

Allows you to set a correction value of the delay time in ns unit that is caused by the Ethernet cable length between the MT1000A and the DUT.

This value is used to correct the measurement results in **Packet TE**.

In the **Packet TE** results, the cable delay caused by the Ethernet cable is included in addition to that caused by communication between the DUT and the MT1000A.

To measure the Packet TE precisely, set the correction value to **Ethernet cable correction**.

For the detail of items, refer to the [Sync Test summary](#) descriptions in Result.

6.13.2.2 Thresholds

Touching the **Thresholds** in the navigation area displays the screen shown below.

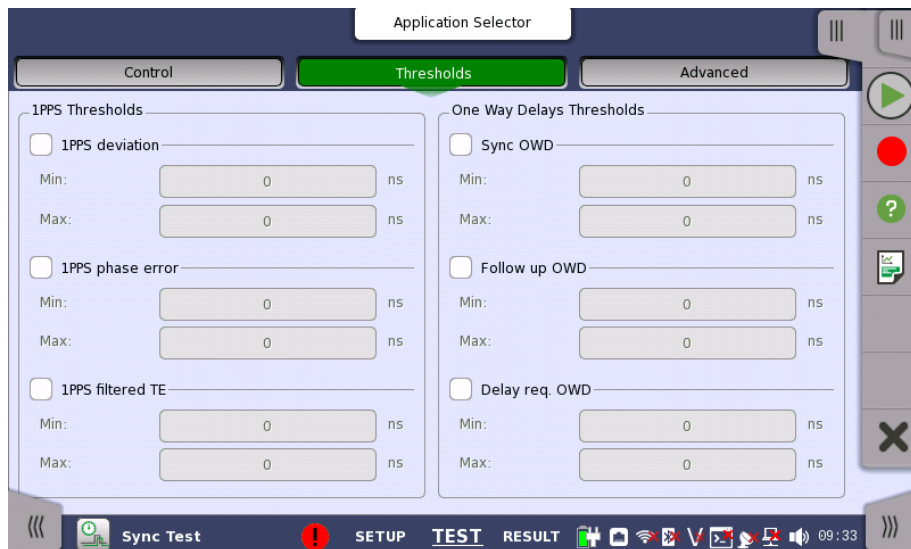

This screen contains the parameters for setting up the various threshold values (i.e. limits) for Pass/Fail status that are used during the monitoring.

If measured results are out of the threshold, they will be marked in red on the Statistics screen.

1 PPS Threshold

1 PPS deviation

Allows to set the threshold range of 1PPS deviation.

1 PPS phase error

Allows to set the threshold range of 1PPS phase error.

1 PPS filtered TE

Allows to set the threshold range of filtered TE.

One way Delay Threshold (OWD)

Sync OWD

Allows to set the threshold range of Sync OWD.

Follow up OWD

Allows to set the threshold range of Follow_Up OWD.

Delay req. OWD

Allows to set the threshold range of Delay_Request OWD.

6.13.2.3 Advanced

On the **Advanced** tab, the **Follow** button appears when the Port 2 settings can follow Port 1.

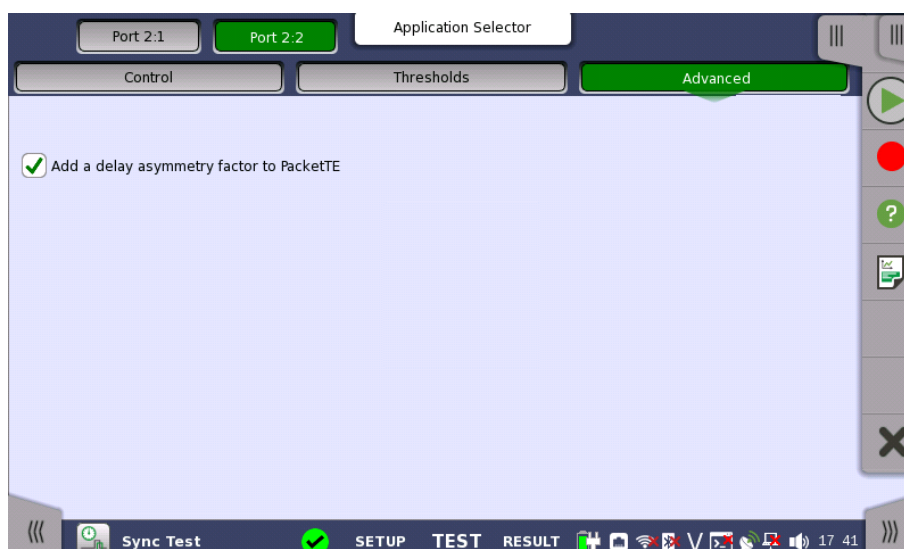

Add a delay asymmetry factor to PacketTE

This check box is available when **G.8275.2** is selected for Profile on the [Setup](#) tab of IEEE 1588v2 page.

This function corrects the delay asymmetry by reflecting the delay asymmetry factor calculated in the different bit rate (delay asymmetry) network to the Packet TE result. For the delay asymmetry caused from the bit rate difference, refer to the standards listed in the [Profile Options](#) tab.

If the check box is selected, the following measurement results are corrected by adding a delay asymmetry factor:

Summary page: cTE1, cTE4, max|TE1|, max|TE4|

[Packet TE](#) page: TE1 and TE4 for the graph

6.13.3 Test Results

6.13.3.1 Summary

Touching the **Summary** in the navigation area displays the screen shown below.

1PPS TE		Packet TE		
			Port 1	Port 2
cTE	-11 ns	cTE1	-115 ns	N/A
dTE	55 ns	cTE4	-84 ns	N/A
max TE	42 ns	max TE1	165 ns	N/A
		max TE4	133 ns	N/A
		Terr	-100 ns	N/A
		max Terr	149 ns	N/A
		Terr(min)	-149 ns	N/A
		Terr(max)	-54 ns	N/A

This screen contains a summary of the results of the Sync Test.

1PPS TE

TE (Time error) represents the phase error (time difference) between the reference 1PPS signal and the 1PPS signal under test. 'N/A' is displayed if the 1PPS signal has not been detected.

- cTE (constant Time Error): Mean value of the phase error
- dTE (dynamic Time Error): Deviation of the filtered TE
- max|TE|: Maximum absolute phase error

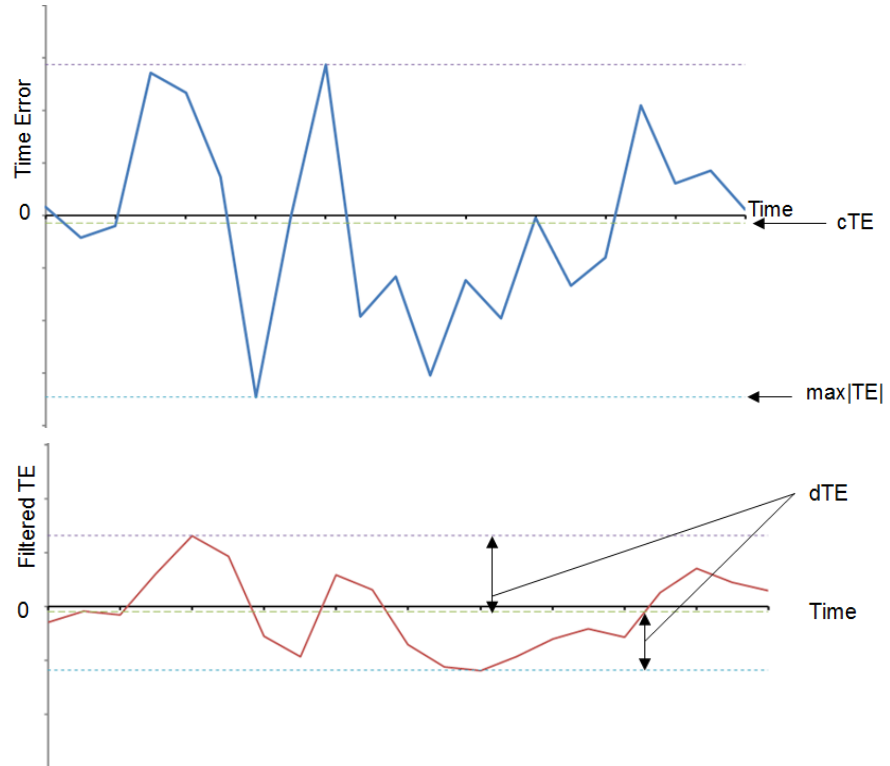

Packet TE

TE (Time error) represents the time difference calculated from timestamps in IEEE1588.2 messages. 'N/A' is displayed when the messages from DUT have not arrived or Network Master behaves as Master clock.

- cTE1: Mean value of TE1
- cTE4: Mean value of TE4
- max|TE1|: Maximum absolute TE1
- max|TE4|: Maximum absolute TE4
- Terr: Time error between DUT and Network Master

$$Terr = \frac{cTE1 + cTE4}{2} = \frac{(avg. Delay_Request\ OWD) - (avg. Sync\ OWD)}{2}$$

- max|Terr|: Maximum absolute Terr
- Terr(min): Minimum value of Terr
- Terr(max): Maximum value of Terr

The each formula is shown below.

$$\begin{aligned}
 cTE1 &= -1 \times (\text{avg. Sync OWD}) + \Delta \text{ms} \\
 cTE4 &= (\text{avg. Delay_Request OWD}) - \Delta \text{sm} \\
 \max|TE1| &= \text{Greater absolute value of } (-1 \times (\text{max. Sync OWD}) + \Delta \text{ms}) \\
 &\quad \text{and } (-1 \times (\text{min. Sync OWD}) + \Delta \text{ms}) \\
 \max|TE4| &= \text{Greater absolute value of } (\text{max. Delay_Request OWD} - \Delta \text{sm}) \\
 &\quad \text{and } (\text{min. Delay_Request OWD} - \Delta \text{sm}) \\
 \max|TErr| &= \max|cTE1 + cTE4|/2 \\
 &= \max|(\text{avg. Delay_Request OWD}) - (\text{avg. Sync OWD})|/2 \\
 \Delta \text{ms} &= \Delta \text{sm} = \text{Ethernet cable delay}
 \end{aligned}$$

6.13.3.2 1PPS

Touching the **1PPS** in the navigation area displays the screen shown below.

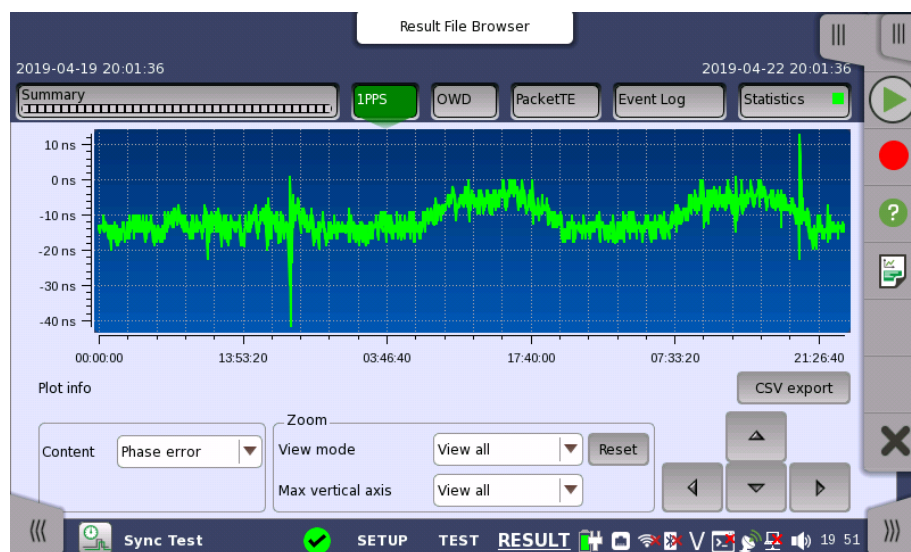

In this screen, the 1PPS test results are displayed as a graph, showing the positions of a time error over time.

CSV export

Outputs measurement results in CSV format.

Content

Select the contents corresponding to the test to display.

- **Phase error:** Phase error (time difference) between two 1PPS signals.
- **Filtered TE:** Displays the Phase error waveform passed through the low pass filter.
- **Deviation:** Pulse period deviation of the 1PPS signal under test.

When selecting **Filtered TE**, noise will be suppressed as shown in the following figure.

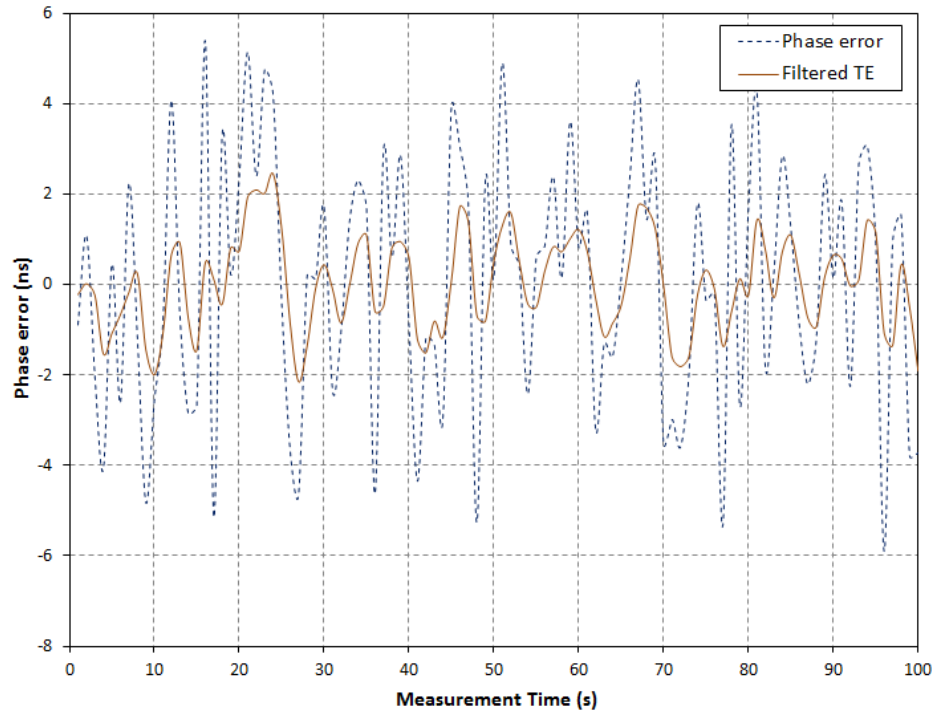

Zoom

To zoom in, select a zoom area directly in the graph area by drawing a rectangle with a finger or the stylus (delivered with the instrument).

When releasing the finger or stylus, the graph area zooms in to show the selected part of the graph.

To zoom out, use the view settings below the graph.

View mode

Used to set the x-scaling for the graph. The possible settings are:

- **Last 1000s, Last 100s:** Shows a sliding graph area with max. width of 1000 second and 100 second.
- **View all:** Shows a graph area with a width as the duration of the test.
- **Custom:** This is automatically selected when the graph area is touchmanipulated.

Max vertical axis

Used to set the y-scaling of the view. The maximum amplitude of the plot always originates from the zero line.



In general, you use direct touch-manipulation of the graph area to zoom in and use the controls to zoom out.

6.13.3.3 OWD

Touching the **OWD** in the navigation area displays the screen shown below.

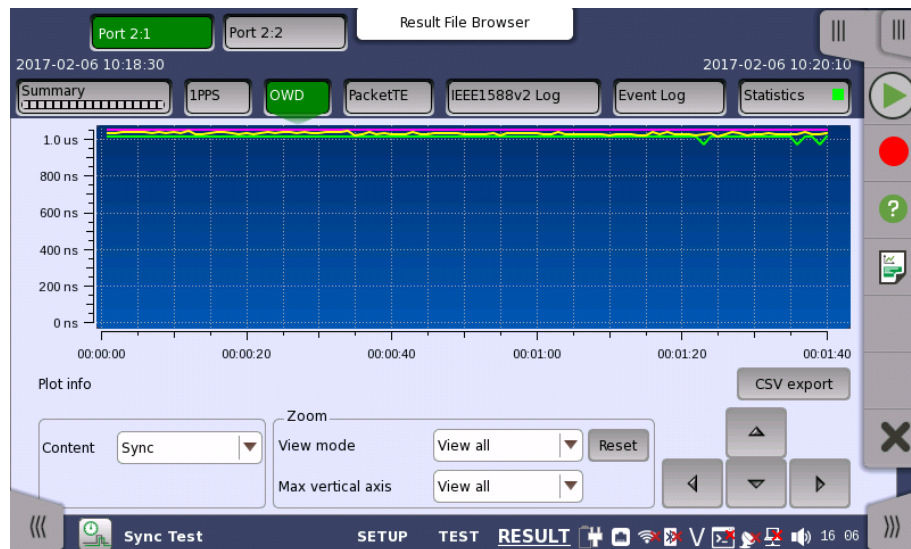

In this screen, the one way delay test results are displayed as a graph, showing the positions of a time error over time.

- Pink line shows maximum one way delay values during one second.
- Yellow line shows average one way delay values during one second.
- Light green line shows minimum one way delay values during one second.

CSV export

Outputs measurement results in CSV format.

Content

Select the contents corresponding to the test to display.

- **Sync**: Displays the one way delay obtained by using the *Sync* message timestamp. This is the delay in direction from DUT to Network Master.
- **Follow up**: Displays the one way delay obtained by using the *Follow_Up* message timestamp. This is the delay in direction from DUT to Network Master.
- **Delay req.**: Displays the one way delay obtained by using the *Delay_Response* message timestamp. This is the delay in direction from Network Master to DUT.

Select **Sync** when Step mode is set to **One-step** in [Setup](#) tab of IEEE1588v2 screen. Select **Follow up** when Step mode is set to **Two-step**.

Zoom

To zoom in, select a zoom area directly in the graph area by drawing a rectangle with a finger or the stylus (delivered with the instrument).

When releasing the finger or stylus, the graph area zooms in to show the selected part of the graph.

To zoom out, use the view settings below the graph.

View mode

Used to set the x-scaling for the graph. The possible settings are:

- **Last 1000s, Last 100s**: Shows a sliding graph area with max. width of 1000 second and 1000 second.
- **View all**: Shows a graph area with a width as the duration of the test.
- **Custom**: This is automatically selected when the graph area is touch-

manipulated.

Max vertical axis

Used to set the y-scaling of the view. The maximum amplitude of the plot always originates from the zero line.



In general, you use direct touch-manipulation of the graph area to zoom in and use the controls to zoom out.

6.13.3.4 Packet TE

Touching the **Packet TE** in the navigation area displays the screen shown below.

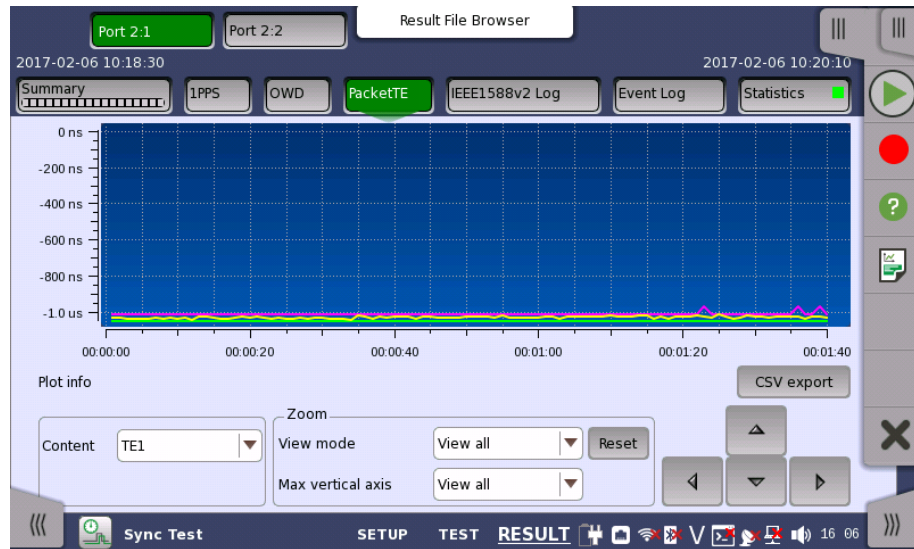

In this screen, the one way delay test results are displayed as a graph, showing the positions of a time error over time.

- Pink line shows maximum time error values during one second.
- Yellow line shows average time error values during one second.
- Light green line shows minimum time error values during one second.

CSV export

Outputs measurement results in CSV format.

Content

Select the contents corresponding to the test to display.

- **TE1**: Mean value of TE1
- **TE4**: Mean value of TE4
- **Terr**: Time error between DUT and Network Master

Refer to [Packet TE](#) in Summary.

Zoom

To zoom in, select a zoom area directly in the graph area by drawing a rectangle with a finger or the stylus (delivered with the instrument).

When releasing the finger or stylus, the graph area zooms in to show the selected part of the graph.

To zoom out, use the view settings below the graph.

View mode

Used to set the x-scaling for the graph. The possible settings are:

- **Last 1000s, Last 100s:** Shows a sliding graph area with max. width of 1000 second and 1000 second.
- **View all:** Shows a graph area with a width as the duration of the test.
- **Custom:** This is automatically selected when the graph area is touch-manipulated.

Max vertical axis

Used to set the y-scaling of the view. The maximum amplitude of the plot always originates from the zero line.



In general, you use direct touch-manipulation of the graph area to zoom in and use the controls to zoom out.

6.13.3.5 Event Log

Touching the **Event Log** button in the navigation area displays the screen providing the event log data. Refer to [Event Log](#) of SDH/SONET/PDH/DSn BERT application.

6.13.3.6 Statistics

Touching the **Statistics** button in the navigation area displays the screen shown below.

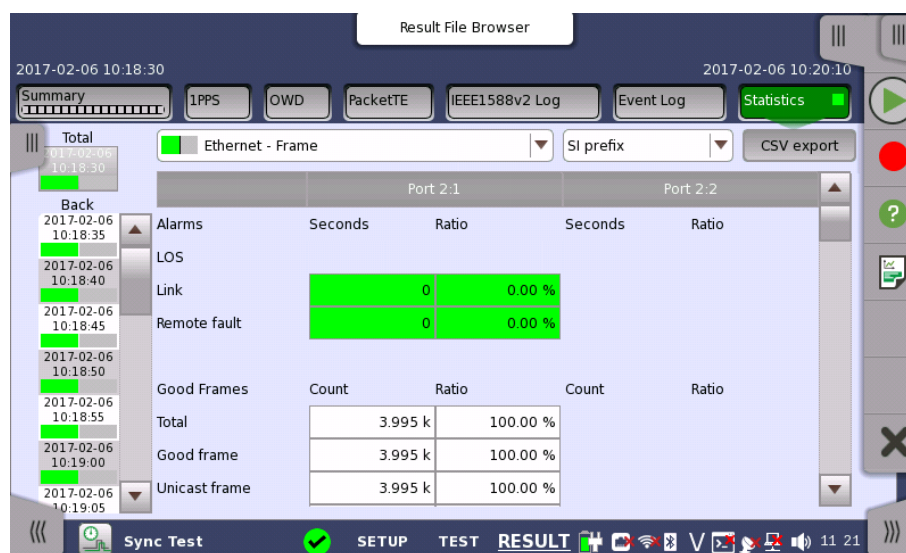

This screen presents a detailed analysis of the test results. You can choose to view either the total results from measurement start or the results of a specific interval during the test. You can also zoom in on a specific result item. The results can be displayed either in table (list) form or as a graph.

Selecting which results to view

Selecting the interval time

Touch the **Total** button to switch the total values measured in all interval times. The start time of measurement is displayed on the button.

Touching the button in left side **Back** field shows the measured values in the interval time. The end time of the interval is displayed on the button.

Current button is displayed at left bottom when the measurement is running. Touching the **Current** button shows the measured values in the current interval time. The start time of the current interval is displayed on the button.

The slide-out panel on the left-hand side of the screen contains the following functions:

- Only show intervals that contains errors
- Time format

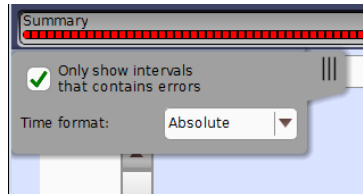

*If you have stopped measurement during the interval time, the measurement results of the current interval are discarded. The log of the current interval is not displayed in **Back** field.*

In this case, result data are re-calculated excluding the data of the current interval when the measurement is stopped. This causes that "Count" and "Ratio" displayed after the measurement will be different from that of during measurement.

The sum of interval time (multiplied interval time by the number of back logs) may not match the differential time between displayed time at left top and right top after the measurement.

Selecting type of results

Open the middle drop-down menu in the top row of buttons to select which results you want to display on the screen.

- Frame
- Transmit
- SyncE
- IEEE 1588v2
- PCS
- 802.3ah
- 802.1ag/Y.1731
- Sync Test

Studying a specific result

Touch a specific cell in a result table to zoom in on the corresponding result item. The **Count** and **Ratio** fields are displayed on a **Zoom** tab page. A **Time vs. Statistics** tab page is also available. Use the **Back** button or touch the zoom filed to return to the statistics screen.

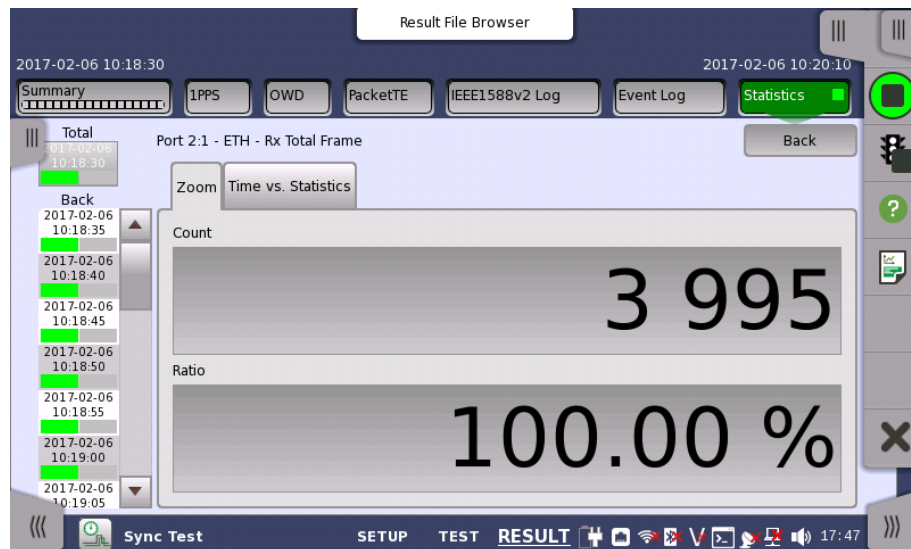

Selecting how results are displayed

Selecting notation

Select the required notation for the results from the notation drop-down menu.

- **Unformatted** - e.g. 71892
- **SI prefix** - e.g. 71.892 k (k means "kilo")
- **Engineering** - e.g. 71.892E3
- **Scientific** - e.g. 7.1892E4

Bits and bytes conversion

The name of the item measured in bits is available as a button. You can convert the unit from Bits to Bytes, by touching the button.

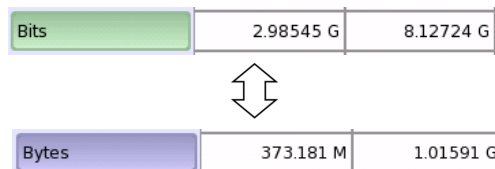

Save results to files

The **CSV Export** button appears when the measurement isn't running. Touch the button, and you can select item(s) you want to export to a CSV file during measurement. The button is not displayed while the measurement is running.

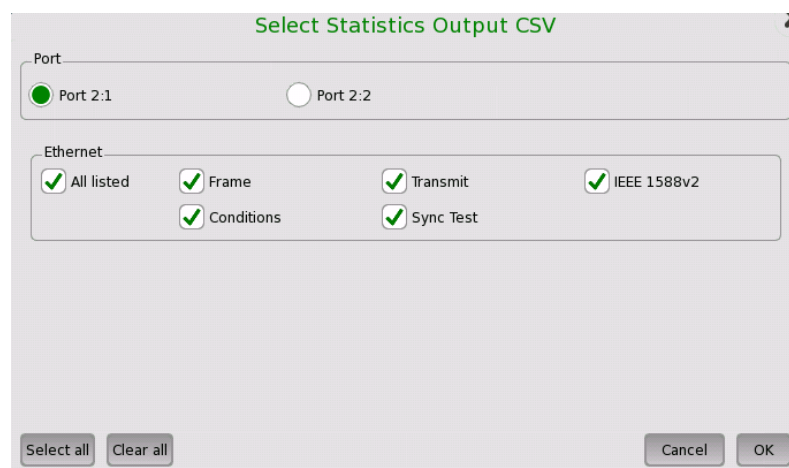

Touch **OK**, and enter the filename.

Results

The result items varies depending on the configuration in Ports Setup screen.

Frame Results

- Alarms
- Good Frames
- Errored Frames
- Layer3 Error
- Other Frames
- Last Received
- Frame diff.

Transmit Results

- Traffic

SyncE Results

- SSM Statistics
- Alarms
- Rx SSM QL

IEEE 1588v2 Results

- Offset Stat
- Offset Variance
- Mean Path Delay
- Path delay variation (PDV)
- Message Stat
- Signalling
- Clock Status Stat.
- GPS - Wall clock

PCS

- PCS 10G

802.3ah Results

802.1ag/Y.1731 Results

Sync Test

- Bit rate
- Bit rate difference
- 1PPS deviation
- OWD



Bit rate and Bit rate difference values appear if the following time has elapsed.

<i>Nominal Bit Rate of the Interface</i>	<i>Required Time</i>
<i>100 Mbps</i>	<i>64 s</i>
<i>1 Gbps</i>	<i>8 s</i>
<i>10 Gbps</i>	<i>8 s</i>
<i>25 Gbps</i>	<i>8 s</i>



- External input
 - Ext. ref. clock
 - Ext. ref. 1PPS
 - 1PPS
- Ethernet
 - Traffic
 - MPLS frame
 - MPLS-TP frame
 - VLAN frame

When Ext. ref. clock lights on green while the 10 MHz clock is input to Ext Clock connector on MT1000A, Bit rate and Bit rate difference results are displayed in every one second period which is synchronized with 10 MHz clock.

When Ext. ref. clock lights on red, Bit rate and Bit rate difference results are displayed in every one second period which is synchronized with internal 10 MHz clock of MT1000A.

6.14 Discovery



The Discovery application searches for another Network Masters connecting to the network. It is also able to change the application running in the discovered Network Master.

The purpose of this application is to switch the application running in the discovered Network Master for running the RFC 2544, RFC 6349, or SAT (Y.1564) application.

For example, when the test mode is set to **End to end network test** in the RFC 2544 application, test can be performed cooperating with opposed side slave equipment by switching Network Master B application to RFC2544 as shown in figure below. For how to operate this example, refer to "[Procedure](#)" section.

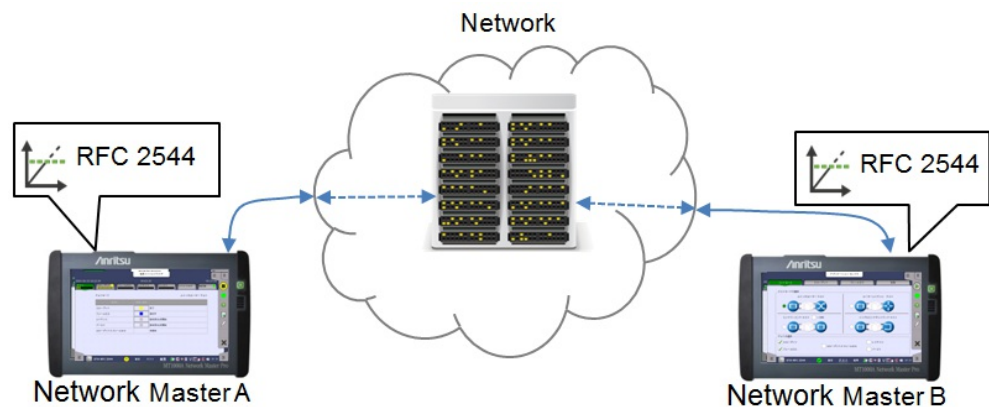

When the test mode is set to **Single ended network test** in the RFC 2544 application, test can be performed cooperating with opposed side reflecting equipment by switching Network Master B application to Reflector as shown in figure below.

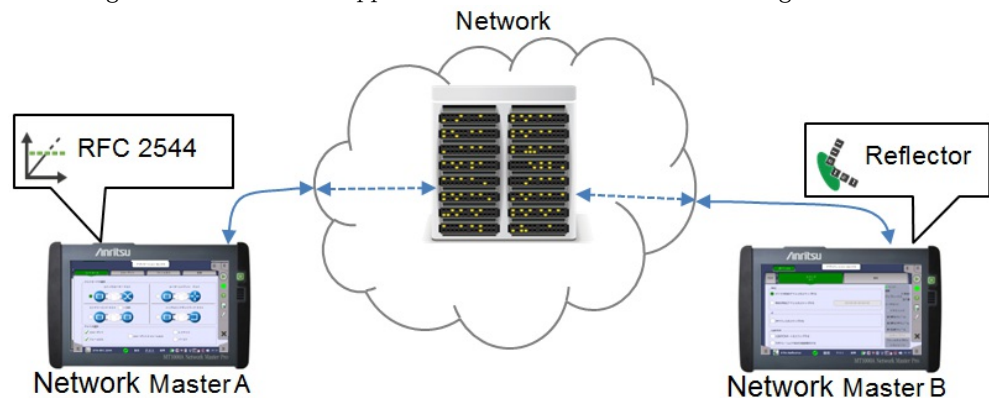

When In-band control is allowed at another port, the Discovery application cannot be started.

Network Master connecting to the network cannot be discovered under the following conditions.

- *The Ethernet application is not running in Network Master.*
- *One of the following applications is running in Network Master:*
 - Cable Test*
 - Pass Through*
 - Ethernet over OTN layer*
- ***Allow In-band control** is not selected.*
- ***Port Setup is set to 10 Gbps WAN.***

6.14.1 Ports Setup and Status

The first step after running an application is to set the port interfaces. Set the port interfaces in the **Ports Setup** screen, which also provides the port status information.

The setup options and status information related to the Ethernet interface are described in the following section:

- [Ethernet Setup and Status](#)

In the Ethernet setup of Discovery, the following two buttons appear in the Navigation area.

- [Port](#)
- [Settings](#)

6.14.2 Test Setup

6.14.2.1 Control

The following screen is displayed to set the test of the Discovery application.

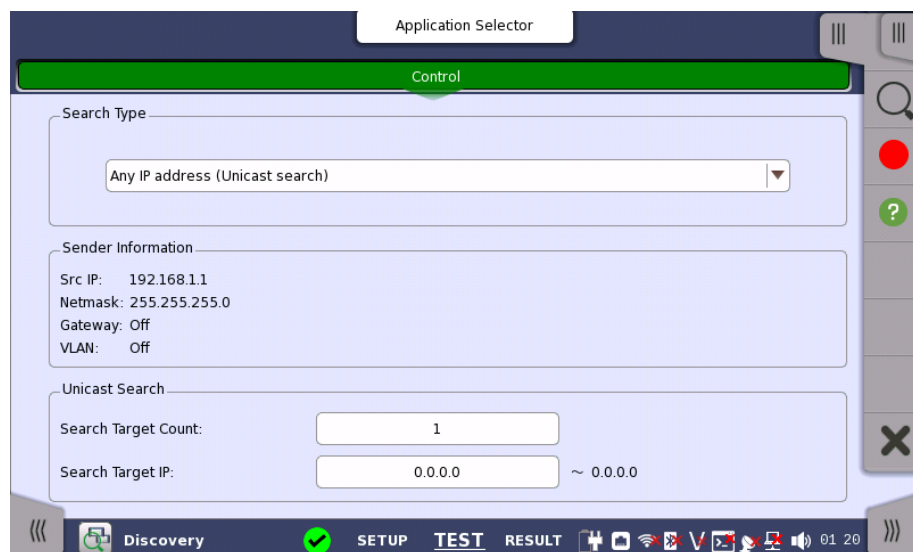

In this screen, the Discovery test method is set.

Search Type

Touch the field to select the way to search for Network Master.

- **Inside local IP network (multicast search):**
Searches for Network Masters using multicast. This searches for Network Master in short time.
- **Any IP address (unicast search):**
Searches for Network Masters using unicast. This searches Network Master existing in the external network via the gateway. It takes a long time, so the dialog box appears during the searching.

Sender Information

The sending frame information which is set in the Settings screen is displayed.

Unicast Search

When **Any IP address (unicast search)** is set at Search Type, set the IP address range of unicast. The IP address changes continuously.

- **Search Target Count:** Set the number of IP addresses to search.
- **Search Target IP:** Set the starting IP address. The ending IP address is displayed at right hand of the field.

6.14.3 Test Results

Perform Discovery



Touching this icon on the Application tool bar starts the processing for discovering Network Masters.

6.14.3.1 Summary

The following screen is displayed to check the test results of the Ethernet Discovery application.

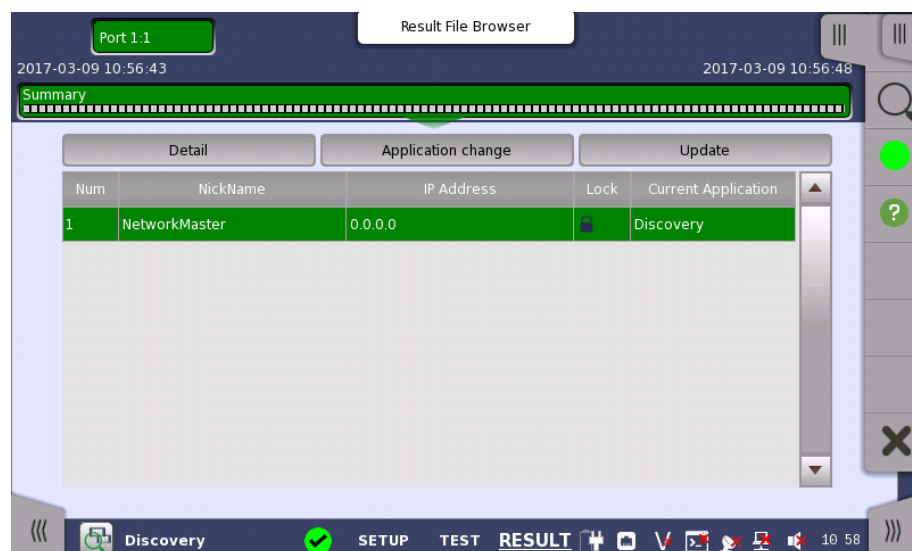

In this screen, up to 16 results of searching for Network Masters are displayed.

If password is set to the Network Master, an icon appears in **Lock** row.

Selecting a line by touching the table enables button operation.

Detail

Touching this button displays the detailed information.

Application change

Touching this button opens the dialog box to change the application running in Network Master.

Update

Touching this button updates the **Current Application** row in the table.

Application

Touch the field to select the application to run in Network Master.

The following items appear according to the **Application change** setting. These settings are applied to the application that has been changed.

MAC

Set Source MAC address.

IP

Set Destination IP address and Source IP address.

Gateway

Select the check box to enable **Gateway** and **Network Mask** settings.

VLAN

Set **Level** and **ID**. Following parameters are fixed value.

Password

When a password has been set to the target Network Master, the **Password** field appears. Enter the password which is set to the target Network Master.

Increment to all streams

When **SAT (Y.1564)** is selected at Application and the check box is selected, the address values (MAC, IP, VAN) at the multi-stream are set incrementally in each stream.



After switching an application, **Answer incoming ARP requests** in the [Settings](#) screen is selected.

After switching to the RFC 2544 and SAT(Y1564) application, the following settings are selected.

Accept Network Master configuration frames in the [Settings](#) screen

Use local source addresses for destination on remote side in the [Advanced](#) screen

After switching to the Reflector application, the following settings in the [Swap](#) screen are selected.

Swap all MAC addresses

Swap IP addresses

Swap UDP/TCP ports

For other settings, the same values are used after switching the application.

6.14.4 Procedure

This section explains the procedure to control the Network Master through a network using Discovery application. In the example here, Network Master B discovers Network Master A. Network Master B switches the application of Network Master A to RFC2544 and performs RFC2544 test.

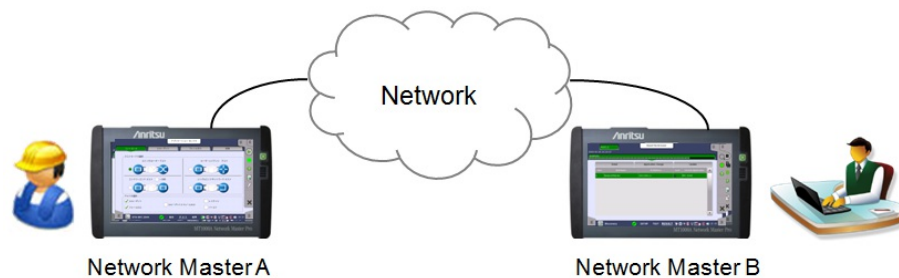

Network Master A Setup

1. Turn on Network Master A.
2. Start one of Ethernet applications on Network Master A.
3. Set up interface on the **Port** screen and establish Ethernet link.

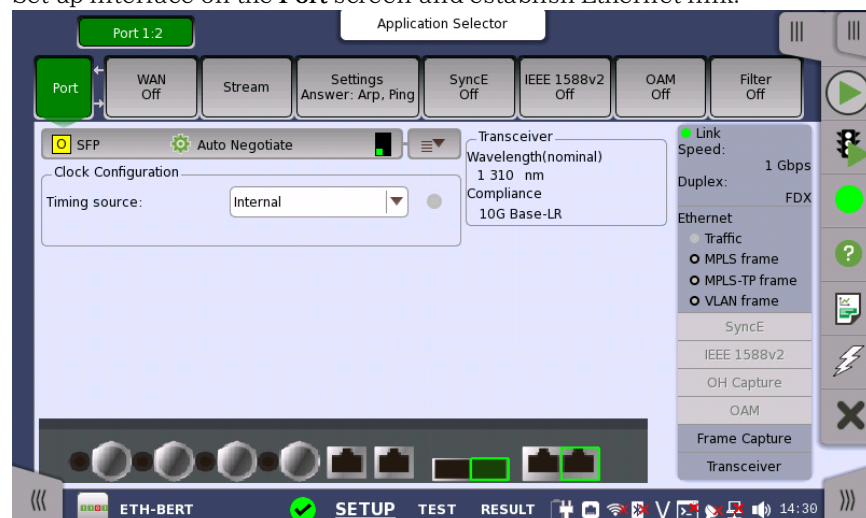

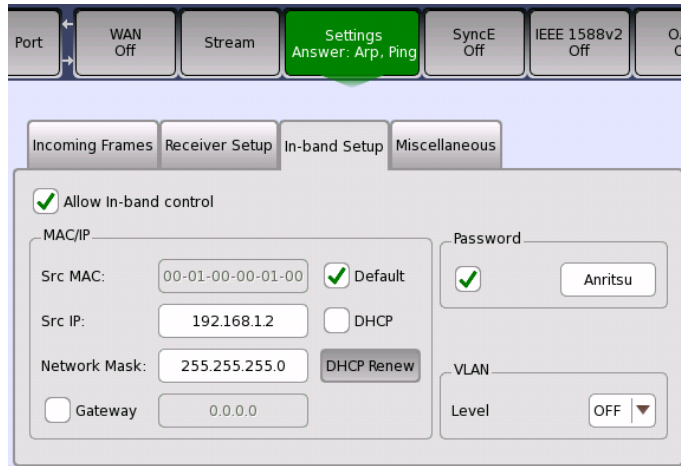

4. Touch the **Settings** on the SETUP screen.
5. Touch the **In-band Setup** tab.
6. Select **Allow in-band control**.



7. Set Src MAC, Src IP which is specified by DHCP or the administrator, and Password. Set Gateway and VLAN if needed.
8. Leave Network Master A powered on.

Network Master B Operation

1. Turn on Network Master B.
2. Touch Discovery  in Ethernet applications.
3. Set up interface on the **Port** screen and establish Ethernet link.
4. Touch  on Application toolbar.
5. If Network Master A is found, touch **Detail**.

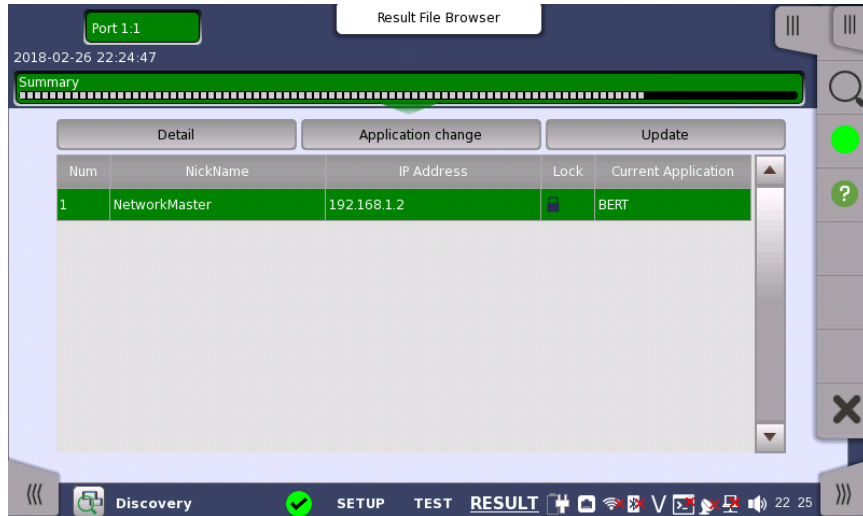



6. Select **RFC2544** as the application to run on Network Master A. Enter a MAC address, IP addresses, and password used for RFC 2544 test of Network Master A.



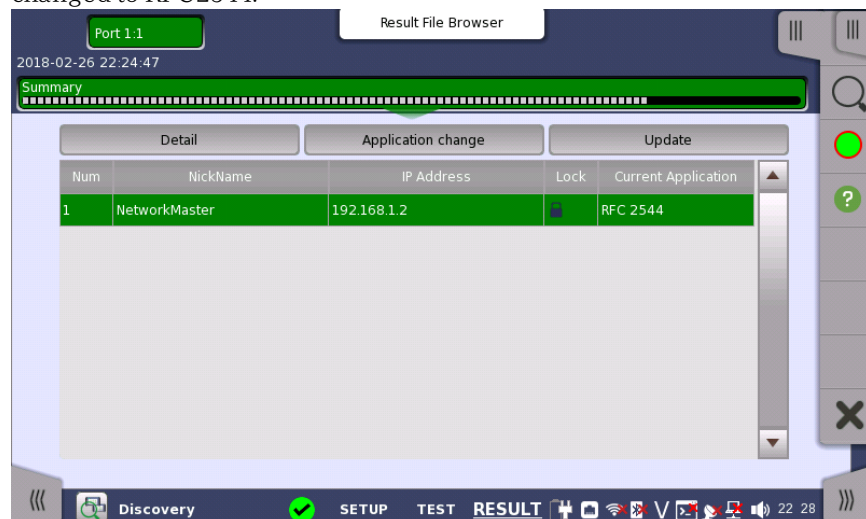

Set an IP address to Src different from one displayed in the figure of step 5.

7. Touch **OK**. It takes a few minutes until the application of Network Master A is changed. MAC address, IP addresses, VLAN settings, and Gateway settings set in the Application Change dialog box will be set to [Streams](#) of Network Master A.
8. Touch **Update**. Confirm that the application of Network Master A has been changed to RFC2544.

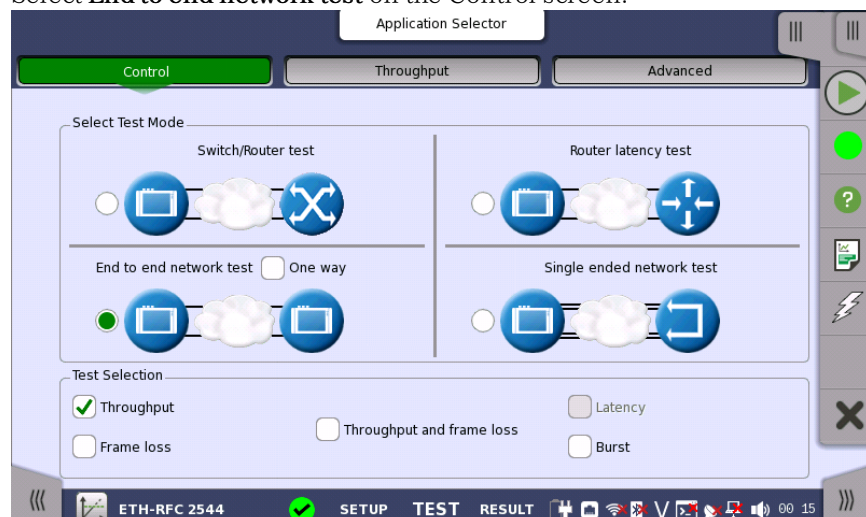

9. Touch **X** on Application toolbar to exit Discovery application.
10. Touch RFC2544 .
11. Set up interface on the **Port** screen and establish Ethernet link.
12. Select **End to end network test** on the Control screen.



13. Touch  on the Application toolbar.
14. After the test finished, Network Master A Measurement Results can be seen on Network Master B.

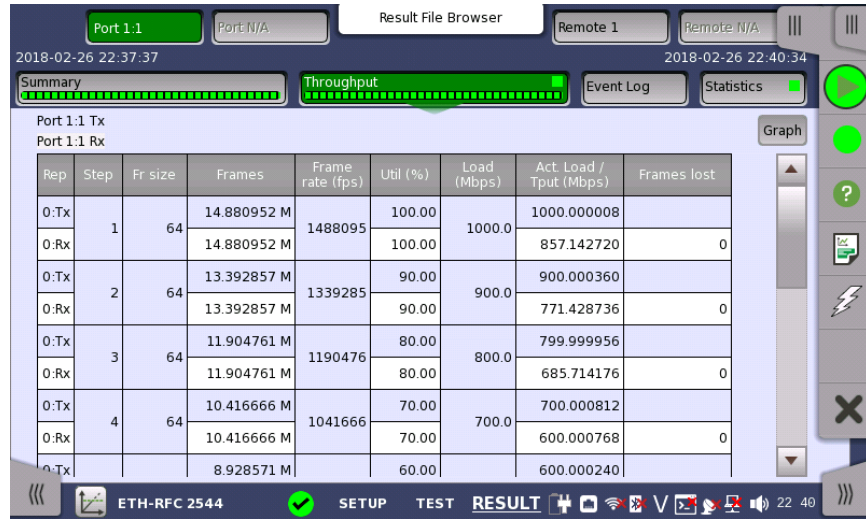

Network Master B Measurement Results (touch **Port 1:1** in navigation area)



Network Master A Measurement Results (touch **Remote 1** in navigation area)

7 OTN Applications

This chapter describes the graphical user interface (i.e. screens, sub-screens and major dialog boxes) related to OTN-only applications. Sub-screens and dialogs are described under the main screen from which they are activated/launched.

The following setting and applications are available:

- [OTN Setup and Status](#)
- [APS](#)
- [BERT](#)
- [RTD](#)



OTN Setup and Status may also be part of the test in following applications.

- *SDH/SONET/PDH/DSn*
- *Ethernet*
- *CPRI/OBSAI*
- *Fibre Channel*

7.1 OTN Setup and Status

An OTUk button in the navigation area of the [Ports Setup](#) screen gives you access to the OTN setup for the transmitter and/or receiver of the currently selected port.

OTN (Optical Transport Networking) provides support for optical networking using wavelength-division multiplexing (WDM). OTN is defined in the ITU-T Recommendation G.709 as a set of Optical Network Elements (ONE) connected by optical fiber links, able to provide functionality of transport, multiplexing, switching, management, supervision and survivability of optical channels carrying client signals.



The OTUk interface uses the optical ports.

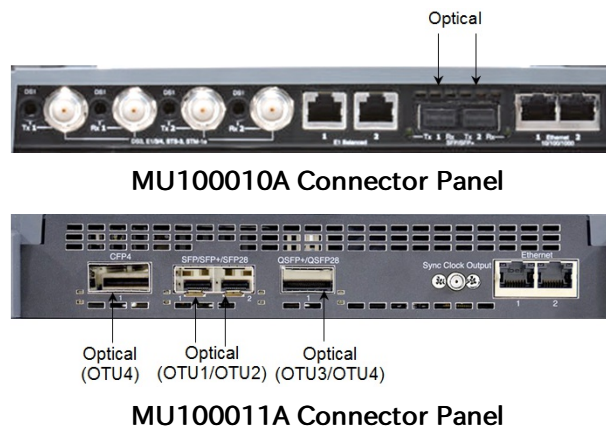

7.1.1 Transmitter Setup

7.1.1.1 Physical Setup

When the transmitter is set up with an OTUk interface, touching the Tx button in the navigation area will launch the following screen.

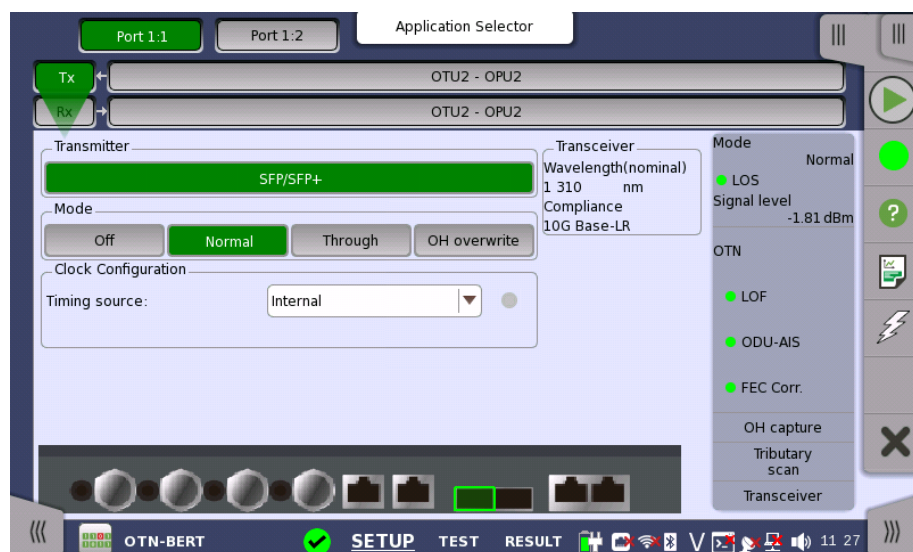

This screen allows you to enable the optical interface of the OTN transmitter. It can also be used to inspect the current status of the selected port by the button in Navigation area.

The configuration options available in the setup area of the screen are described below. The status information is described in a separate section.

- Transmitter**
- **SFP/SFP+**: Available bit rate is up to 2.5 Gbit/s for SFP, up to 10 Gbit/s for SFP+.
 - **QSFP+**: Available bit rate is up to 40 Gbit/s.
 - **QSFP28**: Available bit rate is up to 100 Gbit/s.
 - **CFP4**: Available bit rate is up to 100 Gbit/s.

- Mode**
- Select the transmission mode.
- **Off**: OTUk frame is not transmitted.
 - **Normal**: Transmits OTUk frames generated in the Network Master.
 - **Through** (pass through mode): Transmits the received data.
 - **OH overwrite** (pass through mode with Overhead overwrite): Overwrite the overhead of the received data to OH data generated in Transmit side.

- Clock Configuration**
- Use the drop-down menu to select the clock source. This is fixed to **Received** when **Transmission** is set to **Through** or **OH overwrite**.

Timing Source

Internal: Internal clock of the module

External: The clock input to the connector

GPS: The clock provided from the external GPS sensor

Received: The clock generated from the received signal

When **External**, **GPS** or **Received** is set, the right hand lamp indicates whether clock is detected or not.

- Transceiver**
- Displays the Transceiver information when Optical Transmitter is selected.

- Multi lane mapping**
- In case of OTU3, OTU3e1, OTU3e2, or OTU4, the **Lane Mapping** button appears. Refer to [Multi lane mapping](#) in "Ethernet Setup and Status".

7.1.1.2 OTUk Frame Setup

Touching the navigation area button which represents the transmitter's OTN layer will launch the screen shown below.

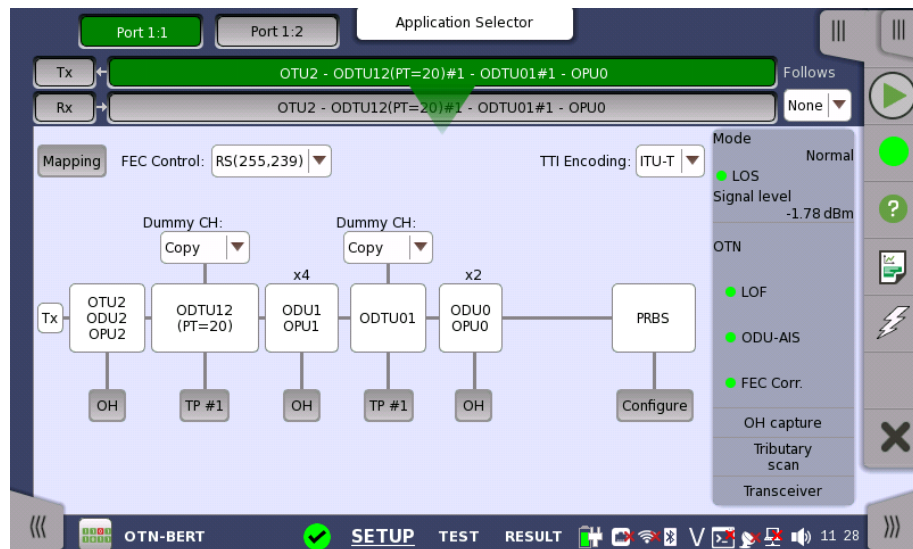

This screen allows you to configure OTUk frame of the currently selected transmitter. It can also be used to inspect the current status of the selected port in a separated screen.

The configuration options available in the setup area of the screen are described below. The status information is described in a separate section.

To setting up the OTU frame, touch **Mapping** button at first. Then select the relevant values for the various containers in the structure shown in the setup area, either by opening a drop-down menu or by touching a button to launch an editor dialog.

Note that the changes you make will be reflected in the text displayed in the OTUk button in the navigation area.

Follows

To make the Port 2 transmitter follow the Port 1 transmitter (i.e. copy its settings), touch the right-most button in the navigation area and select the **Tx1** in the drop-down menu. The Port 2 settings continue to follow the Port 1 transmitter change. The default setting is **None**. Note that the Port 1 transmitter cannot follow the Port 2 transmitter.

Frame Setup

Mapping

Touch the **Mapping** button and use the launched dialog box to define the OTUk frame mapping. The following settings are available:

- [Output Signal](#)
- [Client Signal](#)
- [Multiplexing 1](#)
- [Multiplexing 2](#)
- [Multiplexing 3](#)

See a description of the setting options in the *Mapping Dialog* section below.

FEC Control

Use the drop-down menu to select whether or not to transmit FEC (Forward Error Correction) data.

- **No FEC**: OTUk data is transmitted without FEC encoding.
- **RS(255,239)**: OTUk data is transmitted with FEC encoding. RS(255,239) code is

defined in ITU-T Rec. G.709.

TTI Encoding

Use the drop-down menu to select TTI encoding method.

- **ITU-T:** Corresponding to ITU-T Rec. G.709.
- **ANSI:** All TTI 64 bytes can be edited as the operator specification.

OH

Touch an **OH** button to launch the corresponding **Overhead** dialog box. Depending on whether you have selected multiplexing or not in the frame mapping, there will be one or more overheads to configure.

The dialog box is described in detail in the *Overhead Dialog* section below.

Dummy CH

Only displayed when the frame mapping is set to multiplexing. Select the payload of the dummy channel from the drop-down menu.

- **Copy:** Transmit the copy of the main Tributary Port (TP) data to the dummy Tributary Port (TP).
- **Unused:** Dummy ODUj data which are generated separately from the Main ODUj data are embedded into the remained TPs.

TP

Only displayed when the frame mapping is set to multiplexing. Touch the **TP** button and use the launched dialog box to set the number of TP or TS. The selected TP number is showed on the button.

The dialog box is described in the *TP/TS* section.

GFP-F

Only displayed when the client signal is Ethernet. Touch the **GFP-F** button to launch a dialog box where you can to select parameters.

The dialog box is described in the *GFP-F* section.

GFP-T

Only displayed when the client signal is GbE. Touch the **GFP-T** button to launch a dialog box where you can to select CSF Replacement.

The dialog box is described in the *GFP-T* section.

Configure

Only displayed when the client signal is PRBS. Touch the **Configure** button to launch a dialog box where you can select pattern type.

- **PRBS9 to PRBS31:** Pseudo-random bit sequence. The number indicates the bit length of sequence.
For example, bit length of PRBS9 is $2^9-1=511$.
PRBS Pattern Inversion is enabled.
- **User [32] bit, User [2048] bit:** 32 bits or 2048 bits length pattern.
The field which shows bit length is enabled. Touch the field to launch the dialog box to define the bit pattern. Refer to [The User Pattern Editor](#).

Touching the **Mapping** button in the upper left-hand corner of the **Ports Setup** screen launches the dialog box shown below.

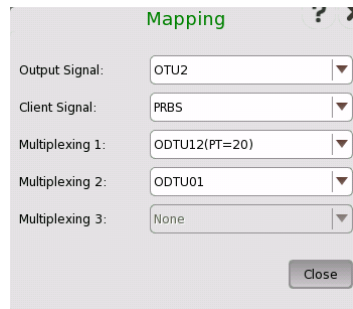

This dialog box allows you to define OTUk frame mapping.

Output Signal

Defines the bit rate the output from the Tx port.

- **OTU1**: 2.666 Gbit/s
- **OTU2**: 10.709 Gbit/s
- **OTU2(Ext.OPU2)**: 10.709 Gbit/s
- **OTU1e**: 11.049 Gbit/s
- **OTU2e**: 11.096 Gbit/s
- **OTU1f**: 11.270 Gbit/s
- **OTU2f**: 11.318 Gbit/s
- **OTU3**: 43.018 Gbit/s
- **OTU3e1**: 44.571 Gbit/s
- **OTU3e2**: 44.583 Gbit/s
- **OTU4**: 111.810 Gbit/s

Client Signal

Defines the Client Signal. The available values change depending on the output signal type and the application.

For the OTN application

- **PRBS**: PRBS
- **NULL**: Null

For the Ethernet +OTN application

- **GbE**: Giga bit Ethernet (1.25 Gbit/s)
- **10GbE**: 10 Giga bit Ethernet (10.3125 Gbit/s)
- **40GbE**: 40 Giga bit Ethernet (41.25 Gbit/s)
- **100GbE**: 100 Giga bit Ethernet (103.125 Gbit/s)
- **Ethernet**: Variable rate
- **MPLS**: MPLS header and payload without Ethernet header
- **IPv4PDU**: IPv4 header and payload without Ethernet header
- **IPv6PDU**: IPv6 header and payload without Ethernet header

*Following options appear when Output signal is set to **OTU4** in BERT application.
MPLS, IPv4PDU, IPv6PDU*

For the SDH/SONET/PDn/DSn +OTN application

- **STM256(Async)**: Synchronous Transport Module-256 (39813.12 Mbit/s)
- **STM64(Async)**: Synchronous Transport Module-64 (9953.28 Mbit/s)
- **STM64(Sync)**: Synchronous Transport Module-64 (9953.28 Mbit/s)

- **STM16(Async)**: Synchronous Transport Module-16 (2488.32 Mbit/s)
- **STM16(Sync)**: Synchronous Transport Module-16 (2488.32 Mbit/s)
- **STM4**: Synchronous Transport Module-4 (622.08 Mbit/s)
- **STM1**: Synchronous Transport Module-1 (155.52 Mbit/s)
- **STS192(Async)**: Synchronous Transport Signal-192 (9953.28 Mbit/s)
- **STS192(Sync)**: Synchronous Transport Signal-192 (9953.28 Mbit/s)
- **STS48(Async)**: Synchronous Transport Signal-48 (2488.32 Mbit/s)
- **STS48(Sync)**: Synchronous Transport Signal-48 (2488.32 Mbit/s)
- **STS12**: Synchronous Transport Signal-12 (622.08 Mbit/s)
- **STS3**: Synchronous Transport Signal-3 (155.52 Mbit/s)
- **Trans.(PRBS)**: PRBS without SDH/SONET header (Same setting as PRBS in OTN application)
- **Trans.(Null)**: Null without SDH/SONET header (Same setting as NULL in OTN application)

For the Fibre Channel +OTN application

- **FC100**: Fibre Channel 100 Mbyte/s (1.0625 Gbit/s)
- **FC200**: Fibre Channel 200 Mbyte/s (2.125 Gbit/s)
- **FC400**: Fibre Channel 400 Mbyte/s (4.25 Gbit/s)
- **FC800**: Fibre Channel 800 Mbyte/s (8.5 Gbit/s)
- **FC1200**: Fibre Channel 1200 Mbyte/s (10.51875 Gbit/s)

For the CPRI +OTN application

- **614.4 M(CPRI)**: CPRI Option 1 (614.4 Mbit/s)
- **1228.8 M(CPRI)**: CPRI Option 2 (1228.8 Mbit/s)
- **2457.6 M(CPRI)**: CPRI Option 3 (2457.6 Mbit/s)
- **3072.0 M(CPRI)**: CPRI Option 4 (3072.0 Mbit/s)
- **4915.2 M(CPRI)**: CPRI Option 5 (4915.2 Mbit/s)
- **6144.0 M(CPRI)**: CPRI Option 6 (6144.0 Mbit/s)
- **9830.4 M(CPRI)**: CPRI Option 7 (9830.4 Mbit/s)
- **10137.6 M(CPRI)**: CPRI Option 8 (10137.6 Mbit/s)

Multiplexing 1

Applicable when there are two or more levels of multiplexing. Defines into which higher order the second level ODU is mapped.

- **None**
- **ODTU4.1** : One 1.25G Tributary Slot (TS)
- **ODTU4.2** : Two 1.25G Tributary Slots (TS)
- **ODTU4.8(ODU2)** : Eight 1.25G Tributary Slots (TS)
- **ODTU4.8(Ext. OPU2)** : Eight 1.25G Tributary Slots (TS)
- **ODTU4.8(ODU2e)** : Eight 1.25G Tributary Slots (TS)
- **ODTU3.1** : One 1.25G Tributary Slot (TS)
- **ODTU23 (PT=20)** : Supports 2.5G Tributary Slot (TS).
- **ODTU23 (PT=20)(Ext. OPU2)** : Supports 2.5G Tributary Slot (TS).
- **ODTU23 (PT=21)** : Supports 1.25G Tributary Slot (TS).
- **ODTU23 (PT=21)(Ext. OPU2)** : Supports 1.25G Tributary Slot (TS).
- **ODTU13 (PT=20)** : Supports 2.5G Tributary Slot (TS).
- **ODTU13 (PT=21)** : Supports 1.25G Tributary Slot (TS).
- **ODTU2e3e1** : Supports 1.25G Tributary Slot (TS).
- **ODTU3e2.8** : Supports 2.5G Tributary Slot (TS).
- **ODTU2.1** : One 1.25G Tributary Slot (TS)
- **ODU2(Ext. OPU2)** : One 1.25G Tributary Slot (TS)

- ODTU12 (PT=20) : Supports 2.5G Tributary Slot (TS).
- ODTU12 (PT=21) : Supports 1.25G Tributary Slot (TS).
- ODTU01 : Supports 1.25G Tributary Slot (TS).

Multiplexing 2

Applicable when there are three levels of multiplexing. Defines into which higher order ODU is multiplexed.

- None
- ODTU2.1 : One 1.25G Tributary Slot (TS) can be selected.
- ODTU12 (PT=20) : Supports 2.5G Tributary Slot (TS).
- ODTU12 (PT=21) : Supports 1.25G Tributary Slot (TS).
- ODTU01 : Supports 1.25G Tributary Slot (TS).

Multiplexing 3

Applicable when Output signal is OTU4 or OTU3.

- None
- ODTU01 : Supports 1.25G Tributary Slot (TS).

7.1.1.4 Overhead

Touching an OH button in the setup area of the **Ports Setup** screen launches a dialog box similar to the one shown below.



This dialog box presents detailed information about the overhead and allows you to configure it. Blue fields are OTU overhead. Green fields except FAS and MFAS are ODU overhead. Orange fields are OPU overhead.

The actual layout of the dialog box depends on which overhead you are configuring. The description below provides a general description of the OTN overhead.

The overhead consists of the following parameters:

- [FAS](#), which is the signal for the frame alignment.
- [MFAS](#), which is the signal for the multiframe alignment.
- [SM](#), which shows the Signal Monitoring.
- [GCC0-GCC2](#), which shows the General Communication Channel.
- RES, which is the reserved for future international standardization.
- [TCM1-TCM6](#), which shows the Tandem Connection Monitoring.
- [FTFL](#), which shows the Fault Type and Fault Location.

- [PM](#), which shows the Path Monitoring.
- EXP, which shows the bytes for experimental use.
- [APS/PCC](#), which shows the Automatic Protection Switching and Protection Communication Control channel.
- [PSI](#), which shows the Payload Structure Identifier.

FAS

Default defined as: F6 F6 F6 28 28 28. To change a byte value, touch the relevant byte button to launch the editor dialog box.



If FAS(s) value is changed, a receiver which received the signal with changed FAS might be able not to detect the frame alignment.

MFAS

This field counts the OTU frame number. The value changes from 0 through 255 cyclically.

SM

SM consists of the following parameters:

- TTI byte (Trail Trace Identifier)
- BIP-8 byte (Bit Interleaved Parity level 8 code)
- 3rd byte:
 - Bits 1-4: BIP violations (BEI/BIAE)
 - Bit 5: Signal fail status (BDI)
 - Bit 6: Frame alignment error (IAE)
 - Bits 7-8: Reserved for future use

The TTI byte and 3rd byte can both be edited by launching the **OTUk SM-TTI** dialog box.

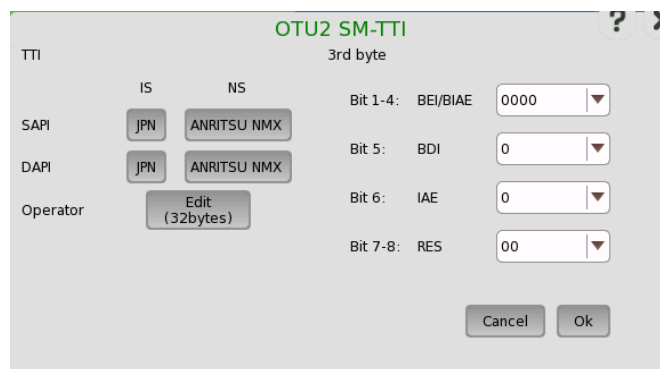

TTI

The TTI (Trail Trace Identifier) is a 64-Byte signal that occupies one byte of the frame and is aligned with the OTUk multiframe.

- SAPI (Source Access Point Identifier)
- DAPI (Destination Access Point Identifier)
- Operator (32-Byte Operator specific)

3rd byte Bit 1-4: BEI/BIAE

Bits 1-4 show BIP violations BEI/BIAE (Backward Error Indication / Backward Incoming Alignment Error). Only **1011** shows BIAE=true.

Bits 1-4	BIP violations
0000	0
0001	1
0010	2
0011	3
0100	4
0101	5
0110	6
0111	7
1000	8
1001 to 1111	0

3rd byte Bit 5: BDI

BDI (Backward Defect Indication) is set to "1" to indicate a signal fail status, otherwise it is set to "0".

3rd byte Bit 6: IAE

IAE (Incoming Alignment Error) is set to "1" to indicate a frame alignment error, otherwise it is set to "0".

3rd byte Bit 7,8: RES

These bits are reserved.

GCC0-GCC2

These fields are used to carry transmission management and signaling information. These bytes can be edited in hexadecimal value.

TCM1-TCM6

TCM1-TCM6 consists of the following parameters:

- TTI byte (Trail Trace Identifier)
- BIP-8 byte (Bit Interleaved Parity level 8 code)
- 3rd byte:
 - Bits 1-4: BIP violations (BEI/BIAE)
 - Bit 5: Signal fail status (BDI)
 - Bits 6-8: Status (STAT)

The TTI byte and 3rd byte can both be edited by launching the **OTUk TCMn-TTI** dialog box, which is similar to the dialog box used to edit SM.

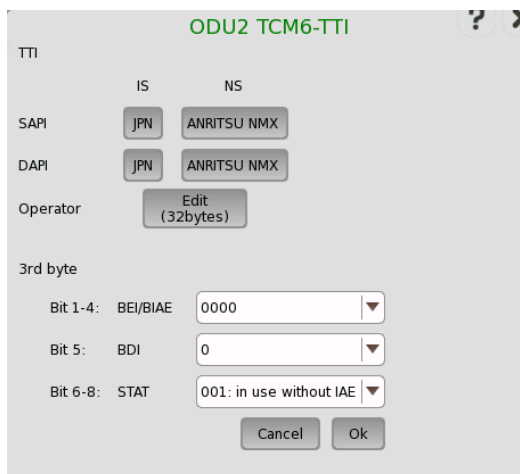

TTI

The TTI (Trail Trace Identifier) is a 64-Byte signal that occupies one byte of the frame and is aligned with the OTUk multiframe.

- SAPI (Source Access Point Identifier)
- DAPI (Destination Access Point Identifier)
- Operator (32-Byte Operator specific)

3rd byte Bit 1-4: BEI/BIAE

Bits 1-4 show BIP violations BEI/BIAE (Backward Error Indication / Backward Incoming Alignment Error). Only **1011** shows BIAE=true.

Bits 1-4	BIP violations
0000	0
0001	1
0010	2
0011	3
0100	4
0101	5
0110	6
0111	7
1000	8
1001 to 1111	0

3rd byte Bit 5: BDI

BDI (Backward Defect Indication) is set to "1" to indicate a signal fail status, otherwise it is set to "0".

3rd byte Bit 6-8: STAT

Bits 6-8 show TCM status.

Bits 6-8	TCM status
000	no source TC
001	in use without IAE
010	in use with IAE
011	Reserved
100	Reserved
101	ODUk-LCK
110	ODUk-OCI
111	ODUk-AIS

FTFL

The FTFL message consists of two 128-byte fields. Launch the **ODUk FTFL** dialog box to edit the fields.

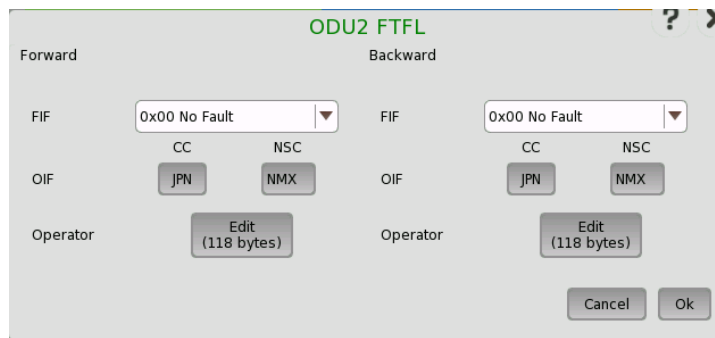

Both messages (Forward and Backward) consist of the following parameters:

FIF (Fault indication field)

Byte	Fault indication
0x00	No Fault
0x01	Signal Fail
0x02	Signal Degrade
0x03 to 0xFF	Reserved

OIF (Operator identifier field)

- CC Country code is a three-character ISO 3166 geographic/political countrycode (G/PCC).
- NSC National segment code is a 1-6 character ITU carrier code (ICC).

Operator (Operator-specific field)

This field is available for operator use. Touching the button launches the *Pattern Editor*.

PM

PM consists of the following parameters:

- TTI byte (Trail Trace Identifier)
- BIP-8 byte (Bit Interleaved Parity level 8 code)
- 3rd byte:
 - Bits 1-4: BIP violations (BEI)

- Bit 5: Signal fail status (BDI)
- Bits 6-8: Status (STAT)

The TTI byte and 3rd byte can both be edited by launching the **ODUk PM-TTI** dialog box, which is similar to the dialog box used to edit SM.

TTI

The TTI (Trail Trace Identifier) is a 64-Byte signal that occupies one byte of the frame and is aligned with the OTUk multiframe.

- SAPI (Source Access Point Identifier)
- DAPI (Destination Access Point Identifier)
- Operator (32-Byte Operator specific)

3rd byte Bit 1-4: BEI

BEI (Backward Error Indication) shows the count of interleaved-bit blocks that have been detected in error by the corresponding ODUk path monitoring sink using the BIP-8 code.

Bits 1-4 shows BIP violations.

Bits 1-4	BIP violations
0000	0
0001	1
0010	2
0011	3
0100	4
0101	5
0110	6
0111	7
1000	8
1001 to 1111	0

3rd byte Bit 5: BDI

BDI (Backward Defect Indication) is set to "1" to indicate a signal fail status, otherwise it is set to "0".

3rd byte Bit 6-8: STAT

STAT (Path Monitoring Status) indicates the presence of a maintenance signal.

STAT	Signal type
000	Reserved
001	Normal path signal
010	Reserved
011	Reserved
100	Reserved
101	ODUk-LCK
110	ODUk-OCI
111	ODUk-AIS

APS/PCC

APS/PCC has four bytes. Requests/Status is defined for First byte. The request or status is shown in bits 1-4.

The protection type is shown in bit 5-8.

The screenshot shows a configuration dialog box titled "ODU2 APS/PCC[1]". It contains the following settings:

- Bit 1-4: A dropdown menu showing "0000: NR".
- Bit 5: Two radio buttons, "No APS Channel" (selected) and "APS Channel".
- Bit 6: Two radio buttons, "1+1" (selected) and "1:n".
- Bit 7: Two radio buttons, "Unidirectional" (selected) and "Bidirectional".
- Bit 8: Two radio buttons, "Non-Revertive" (selected) and "Revertive".

At the bottom right, there are "Cancel" and "Ok" buttons.

Bits 1-4	Meaning
0000	NR (No request)
0001	DNR (Do not revert)
0010	RR (Reverse request)
0011	Reserved
0100	EXER (Exercise)
0101	Reserved
0110	WT (Wait-to-restore)
0111	Reserved
1000	MS (Manual switch)
1001	Reserved
1010	SD (Signal degrade)
1011	Reserved
1100	SF (Signal fail)
1101	Reserved
1110	FS (Forced switch)
1111	Lockout

PSI

PSI means Protocol Structure Identifier. This field shows the payload type. You can either enter a new value directly in the field or select the relevant value from the **PSI[0]** drop-down menu.

PSI value	Payload type
0x01	Experimental mapping
0x02	Asynchronous CBR mapping
0x03	Bit synchronous CBR mapping
0x04	ATM mapping
0x05	GFP mapping
0x06	Virtual Concatenated signal
0x07	PCS codeword transparent Ethernet mapping: 100GBASE-X into OPU0 40GBASE-R into OPU3 100GBASE-R into OPU4
0x08	FC-1200 into OPU2e mapping
0x09	GFP mapping into Extended OPU2

PSI value	Payload type
0x0A	STM-1 mapping into OPU0
0x0B	STM-4 mapping into OPU0
0x0C	FC-100 mapping into OPU0
0x0D	FC-200 mapping into OPU1
0x0E	FC-400 mapping into OPUflex
0x0F	FC-800 mapping into OPUflex
0x10	Bit stream with octet timing mapping
0x11	Bit stream without octet timing mapping
0x12	IB SDR mapping into OPUflex
0x13	IB DDR mapping into OPUflex
0x14	IB QDR mapping into OPUflex
0x15	SDI mapping into OPU0
0x16	(1.485/1.001) Gbit/s SDI mapping into OPU1
0x17	1.485 Gbit/s SDI mapping into OPU1
0x18	(2.970/1.001) Gbit/s SDI mapping into OPUflex
0x19	2.970 Gbit/s SDI mapping into OPUflex
0x1A	ESCON mapping into OPU0
0x1B	DVB_ASI mapping into OPU0
0x1C	FC-1600 mapping into OPUflex
0x20	ODU multiplex structure supporting ODTUjk only (AMP only)
0x21	ODU multiplex structure supporting ODTUk.ts or ODTUk.ts and ODTUjk (GMP capable)
0x55	Not available
0x66	Not available
0x80	Reserved code for proprietary use (non-standard payload mappings)
0xFD	NULL test signal mapping
0xFE	PRBS test signal mapping
0xFF	Not available

7.1.1.5 TP/TS

Touching a **TP** button on the **Ports Setup** screen launches the **TP/TS** dialog box. Note that the contents and layout of the dialog box depends on which higher order type has been selected.

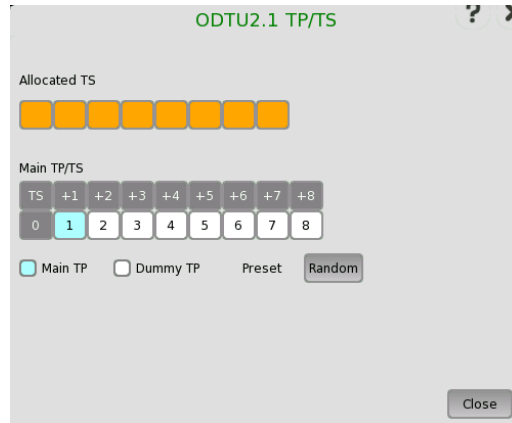

This dialog box allows you to define OTUk frame mapping.

- **Main TP/TS**: Tributary Port/Slot number of Measurement target for Lower order ODU frame.
- **Dummy TP**: Condition of TP/TS(s) other than Main TP/TS. Transmitted signal is selected by *Dummy CH*.
 - **Copy**: The same signal as Main TP/TS is transmitted.
 - **Unused**: Lower order ODU frame constructed of PRBS mapping is transmitted.

7.1.1.6 GFP-T

GFP-T means Transparent Generic Framing Procedure, defined by ITU-T Rec. G.7041/Y.1303. When OTN layer is added to Ethernet applications, **GFP-T** button appears in the setup area of the **Ports Setup** screen if Client Signal is selected to **GbE**. Touching an **GFP-T** button launches the below dialog box.

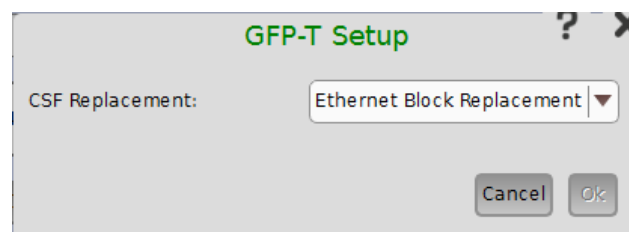

CSF Replacement

Setting behavior of GFP-T when CSF (Client Signal Fail) occurs.

- **Ethernet Block Replacement** :Transmits 10B data to indicate the link error.
- **GFP-T CSF Replacement** :Transmits CSF and IDLE frames CSF is transmitted with 500 ms interval.

7.1.1.7 GFP-F

GFP-F means Frame-mapped Generic Framing Procedure, defined by ITU-T Rec. G.7041/Y.1303. When OTN layer is added to Ethernet applications, **GFP-F** button appears in the setup area of the **Ports Setup** screen if Client Signal is selected to **Ethernet**. Touching an **GFP-F** button launches the below dialog box.

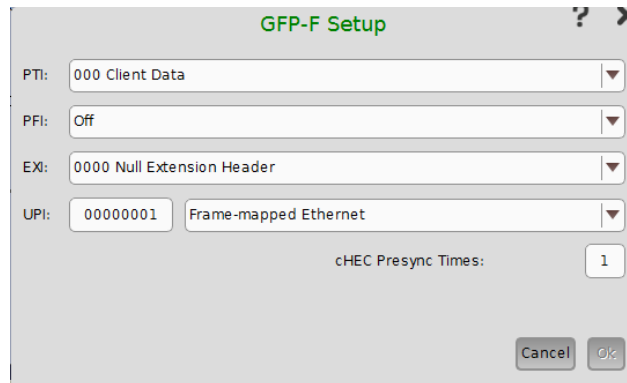

PTI

Set three bits of PTI (Payload Type Identifier). When setting PTI to **100-Client Management**, all transmitting GFP-F frames is Client Management Frame.

PFI

Set a bit of PFI (Payload Frame Check Sequence Identifier). **On** presents payload FCS (Frame Check Sequence). **Off** absents payload FCS.

EXI

Set four bits of EXI (Extension header Identifier).

UPI

Set eight bits of UPI (User Payload Identifier). When PTI is **000 Client Data** , set the type of payload. When PTI is **100 Client Management**, set the type of management signal.

cHEC Presync Times

The number of continuous receptions of normal cHEC (core Header error check) until HUNT status is transited to SYNC status

7.1.2 Receiver Setup

7.1.2.1 Physical Setup

When the receiver is set up with an OTUk interface, touching the **Rx** button in the navigation area will launch the following screen.

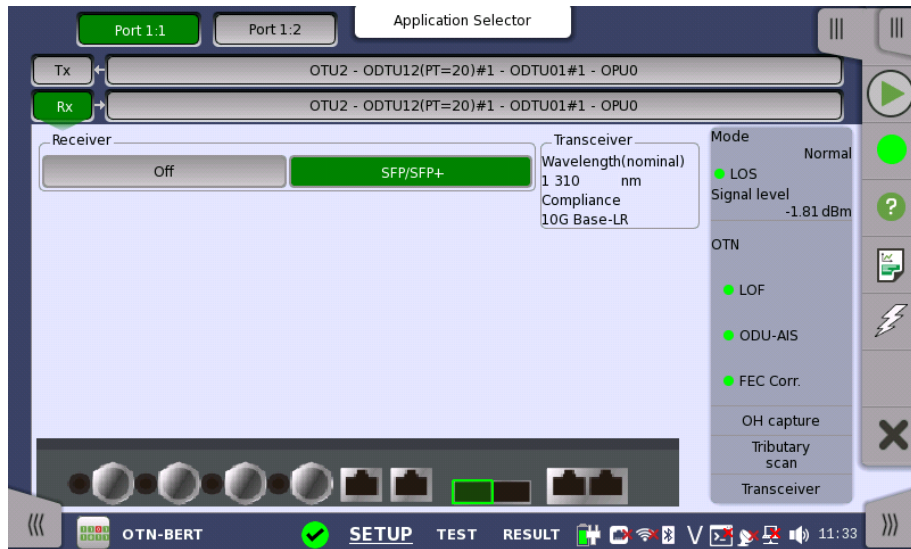

This screen allows you to make the physical setup of the receiver in OTN mode. It can also be used to inspect the current status of the selected port by the button in Navigation area.

The configuration options available in the setup area of the screen are described below. The status information is described in a separate section.

Receiver

Touch the button to select the interface.

- **Off:** No signal input interface.
- **SFP/SFP+:** Available bit rate is up to 2.5 Gbit/s for SFP, up to 10 Gbit/s for SFP+.
- **QSFP+:** Available bit rate is up to 40 Gbit/s.
- **QSFP28:** Available bit rate is up to 100 Gbit/s.
- **CFP4:** Available bit rate is up to 100 Gbit/s.

Transceiver

Displays the Transceiver information.

7.1.2.2 OTUk Frame Setup

Touching the navigation area button which represents the receiver's OTN layer will launch the screen shown below.

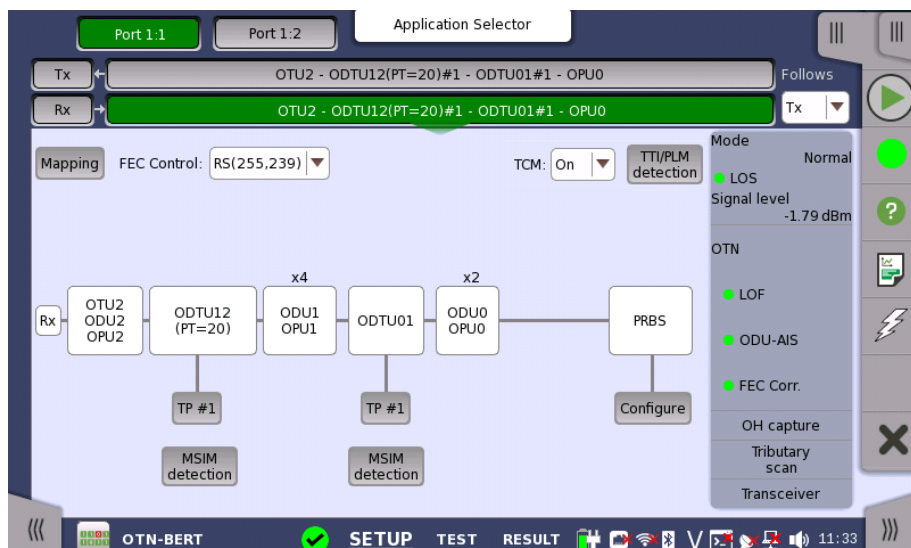

This screen allows you to configure OTUk frame of the currently selected receiver. It can also be used to inspect the current status of the selected port in a separate screen.

To setting up the OTU frame, touch **Mapping** button at first. Then select the relevant values for the various containers in the structure shown in the setup area, either by opening a drop-down menu or by touching a button to launch an editor dialog box.

Note that the changes you make will be reflected in the text displayed in the OTUk button in the navigation area.

Follows

To make the currently selected receiver follow either the transmitter or Port 1 receiver (i.e. copy its settings), touch the right-most button in the navigation area and select the relevant value in the drop-down menu. The receiver settings continue to follow the change of either the transmitter or Port 1 receiver. The default setting is **Tx**. Note that the Port 1 receiver cannot follow the Port 2 receiver.

Frame Setup

Mapping

Touch the **Mapping** button and use the launched Dialog box to define the OTUk frame mapping. The following settings are available:

- [Input Signal](#)
- [Client Signal](#)
- [Multiplexing 1](#)
- [Multiplexing 2](#)
- [Multiplexing 3](#)

See a description of the setting options in the *Mapping* section under setup of transmitter.

FEC Control

Use the drop-down menu to select whether or not to transmit FEC (Forward Error Correction) data.

- **No FEC**: FEC Decoding (Error Correction) is set OFF.
- **RS(255,239)**: FEC Error Correction is active based on RS(255,239) code defined in ITU-T Rec. G.709.

TTI/PLM detection

Launches the **TTI/PLM detection** dialog box where you can select detection method for SM, PM, and TCM1-6.

The dialog box is shown and described in the *TTI/PLM detection* section.

Auto, TP

Only displayed when the frame mapping is set to multiplexing. Touch the **Auto** or **TP #** button and use the launched dialog box to set the number of TP or TS. When **Manual** or **Auto detect TS** are selected, TP number can be detect automatically, so "Auto" is shown on the button. **Auto detect TP** is selected, TP number can be set directly. So "TP #" is shown on the button.

The dialog box is described in the *TP/TS* section below.

MSIM detection

Only displayed when the frame mapping is set to multiplexing. Touch the **MSIM detection** button and use the launched dialog box to set the detection method of MSIM.

The dialog box is shown and described in the *MSIM Detection* section.

Configure

Only displayed when the client signal is PRBS. Touch the **Configure** button to launch a dialog box where you can select pattern type.

- **PRBS9 to PRBS31**: Pseudo-random bit sequence. The number indicates the bit length of sequence.

For example, bit length of PRBS9 is $2^9-1=511$.

- **User [32] bit, User [2048] bit**: 32 bits or 2048 bits length pattern. The field which shows bit length is enabled. Touch the field to launch the dialog box to define the bit pattern. Refer to [The User Pattern Editor](#).

TCM

Use the drop-down menu to select whether or not to enable measuring TCM (Tandem Connection Monitoring) alarms and errors.

- **On**: Enables measuring TCM alarms and errors.
- **Off**: Disables measuring TCM alarms and errors.

7.1.2.3 TP/TS

Touching a **TP** or **Auto** button on the **Ports Setup** screen launches the **TP/TS** dialog box. Note that the contents and layout of the dialog box depends on which higher order type has been selected.

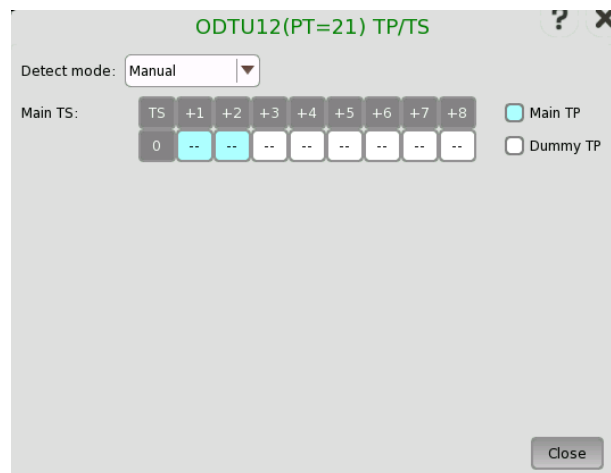

TP/TS dialog box has three screen depending on the **Mode** setting.

7.1.2.4 TTI/PLM detection

Touching the **TTI/PLM detection** button in the upper right-hand corner of the **Ports Setup** screen launches the dialog box shown below.

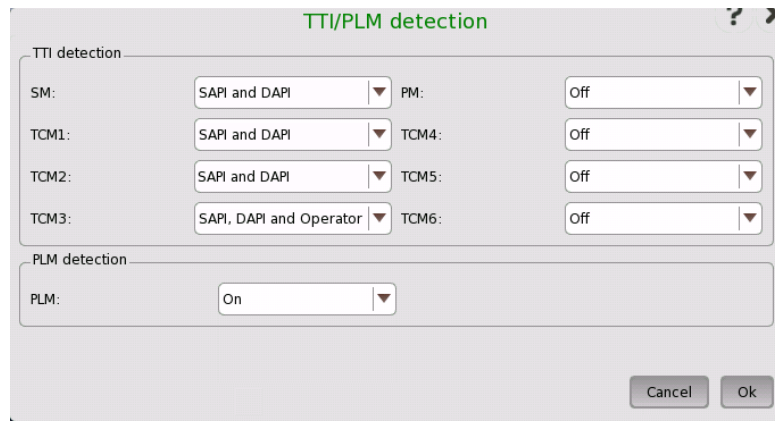

TTI detection

TTI detection allows you to select the detection method for SM, PM, and TCM1-6.

- **Off** Disables the TTI (Trail Trace Identifier) detection.
- **SAPI** (Source Access Point Identifier)
- **DAPI** (Destination Access Point Identifier)
- **SAPI and DAPI**
- **SAPI, DAPI and Operator** (32-Byte Operator specific)

PLM detection

Selecting **On** enables the PLM (Payload Label Mismatch) detection.

7.1.2.5 MSIM detection

Touching an **MSIM detection** button on the **Ports Setup** screen launches the **MSIM Detection** dialog box.

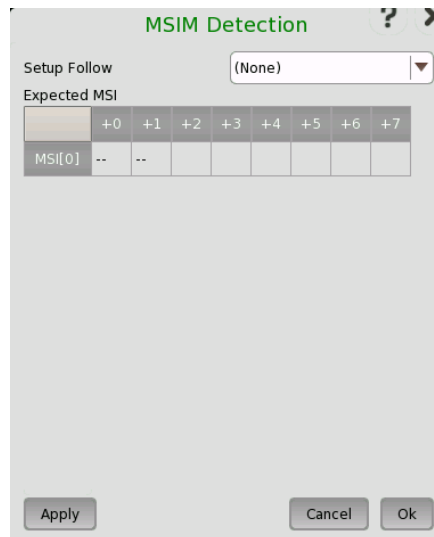

The dialog box is used to set the detection method of MSIM (Multiplex Structure Identifier Mismatch).

Setup Follow

Select the source of the Expected MSI in the drop-down menu. The expected MSI is displayed in the dialog box.

- **(None)** : MSIM is not detected.

- **Tx Data** : Expected MSI are copied from OH Preset data.
- **Received Data**: Expected MSI are set from received MSI data.

7.1.3 Status Information

This section describes the status information available for the OTN layer in the status area of the **Ports Setup** screen.

7.1.3.1 Status Summary

The status summary displayed for the OTN layer consists of the following information:

Physical Status

The topmost part of the status area gives you access to information about the current physical status of the selected interface. A summary consisting of the most relevant status indicators is displayed constantly. By touching the summary, you can launch a display that contains the detailed status information.

Alarm/Error Status

The middle part of the status area gives you access to alarm and error information for the selected interface. The status is indicated by the lamp color. You can choose whether to view only the current alarm and error status, or to view all alarms and errors in the alarm trap since it was last reset.

A summary consisting of the most relevant alarm/error indications is displayed constantly. By touching the summary, you can launch a display that contains all alarms/errors.

Capture/Monitor Status

At the bottom of the status area are below buttons that give you access to various capture/monitor information. By touching a button, you can launch the corresponding information display.

- **OH capture**
- **Tributary scan**
- **Transceiver**

7.1.3.2 Physical Details

Touching the topmost summary box in the status area of the **Ports Setup** screen displays the status shown below.

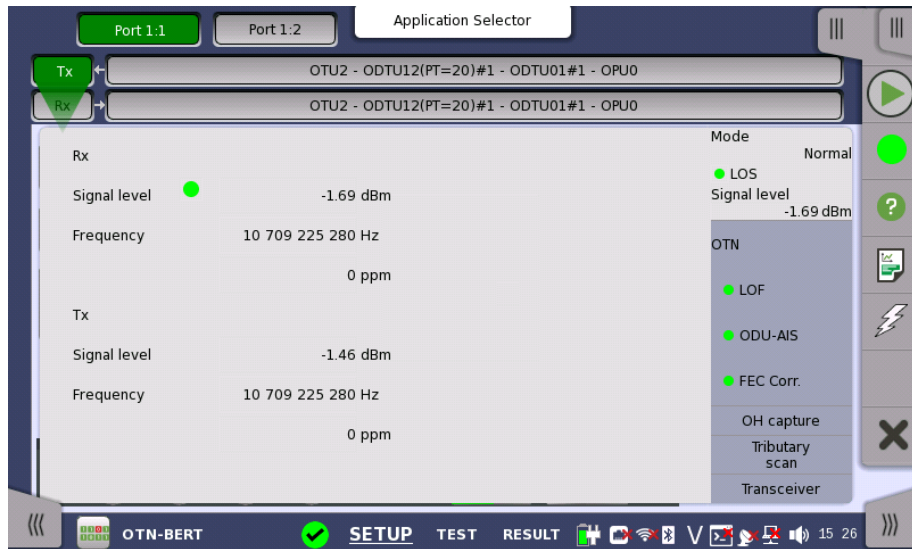

This screen presents detailed information about the current physical status of the optical signal.

Rx

Signal Level

Shows the input level of an optical signal. A lamp icon indicates the LOS state.

Frequency

Shows the input signal frequency and the deviation of the input signal from the nominal bit rate in ppm.

Tx

Signal Level

Shows the output level of an optical signal.

Frequency

Shows the output signal frequency and the deviation of the output signal from the nominal bit rate in ppm.

7.1.3.3 Alarms and Errors

Touching the middle summary box in the status area of the **Ports Setup** screen displays the status shown below.

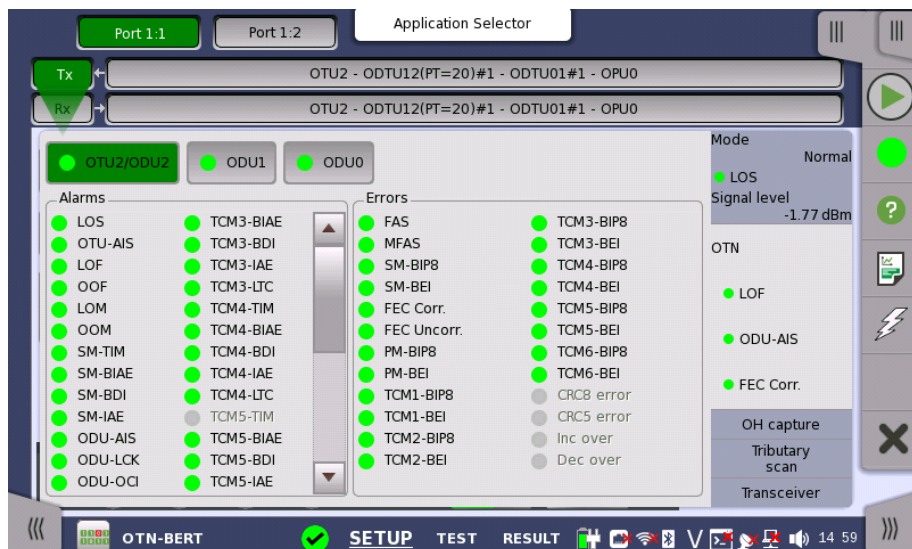

This screen contains detailed alarm and error information related to the OTN layer. Status is indicated by the use of [colored lamp icons](#).

Level-specific alarms If the ODUk is multiplexed, touch the relevant OTU/ODUk level button.

Alarms

OTL Alarms

LOF-OTL: Loss of Frame of Optical channel Transport Lane
OOF-OTL: Out of Frame of Optical channel Transport Lane
LOR-OTL: Loss of Recovery of Optical channel Transport Lane
OOR-OTL: Out of Recovery of Optical channel Transport Lane
ILA/OLA: Shows the lane alignment process.
 Green indicates ILA (In-Lane Alignment).
 Red indicates OLA (Out-Of-Lane Alignment).

OTU Alarms

LOS: Loss of Signal.
OTU-AIS: Optical channel Transport Unit Alarm Indication Signal.
LOF: Loss of Frame
OOF: Out of Frame
LOM: Loss of Multiframe
OOM: Out of Multiframe
SM-TIM: Section Monitoring Trail trace Indicator Mismatch
SM-BIAE: Section Monitoring Backward Incoming Alignment Error
SM-BDI: Section Monitoring Backward Defect Indicator
SM-IAE: Section Monitoring Incoming Alignment Error

ODU Alarms

LOFLOM: Loss of Frame and Loss of Multiframe
ODU-AIS: Optical channel Data Unit Alarm Indication Signal
ODU-LCK: Optical channel Data Unit Locked Signal
ODU-OCI: Optical channel Data Unit Open Connection Indication
PM-TIM: Path Monitoring Trail trace Indicator Mismatch
PM-BDI: Path Monitoring Backward Defect Indicator
PLM: Payload Mismatch
FSF: Forward Signal Fail
FSD: Forward Signal Degrade
BSF: Backward Signal Fail
BSD: Backward Signal Degrade
MSIM: Multiple Structure Identifier Mismatch
CI-AIS: Characteristic Information Alarm Indication Signal
CSF: Client Signal Fail
LSS: Link Status Signal

TCM Alarms

TIM: Trace Indicator Mismatch
BIAE: Backward Incoming Alignment Error
BDI: Backward Defect Indicator
IAE: Incoming Alignment Error
LTC: Loss of Tandem Connection

Errors

OTL Errors

FAS-OTL: Frame Alignment Signal of Optical channel Transport Lane
MFAS-OTL: Multiframe Alignment Signal of Optical channel Transport Lane

LLM-OTL: Loss of Lane Marker of Optical channel Transport Lane

OTU Errors

FAS: Frame Alignment Signal

MFAS: Multiframe Alignment Signal

SM-BIP8: Section Monitoring Bit Interleaved Parity 8

SM-BEI: Section Monitoring Backward Error Indication

FEC Corr.: Forward Error Correction Corrected

FEC Uncorr.: Forward Error Correction Uncorrected

ODU Errors

PM-BIP8: Path Monitoring Bit Interleaved Parity 8

PM-BEI: Path Monitoring Backward Error Indicator

OPU Errors

Pattern error: Bit error detected in the payload

TCM Errors

TCMi-BIP8: Bit Interleaved Parity 8

TCMi-BEI: Backward Error Indication

(i=1 to 6)

GMP Errors

CRC8 error: CRC8 error occurred

CRC5 error: CRC5 error occurred

Inc over: $C_m(t)$ value exceeds the upper limit.

Dec over: $C_m(t)$ value exceeds the lower limit.

GFP Errors

cHEC Corr.: core Header Error Check Correctable

cHEC Uncorr.: core Header Error Check Uncorrectable

tHEC Corr.: type Header Error Check Correctable

tHEC Uncorr.: type Header Error Check Uncorrectable

eHEC Corr.: extension Header Error Check Correctable

eHEC Uncorr.: extension Header Error Check Uncorrectable

Invalid GFP frame: Invalid Transport Generic Frame Procedure Frame

Superblock CRC: Superblock where CRC error occurred

CSF signal: Client Signal Fail

CSF sync: Client Signal Fail synchronization

FCS error: Frame Check Sequence error detected

CMF signal: Client Management Frame

CMF sync: Client Management Frame synchronization

SSF: Server Signal Failure

PTI Mismatch: Payload Type Identifier Mismatch

UPI Mismatch: User Payload Identifier Mismatch

7.1.3.4 OH capture

Touching the **OH capture** button in the status area of the **Ports Setup** screen displays the status shown below.

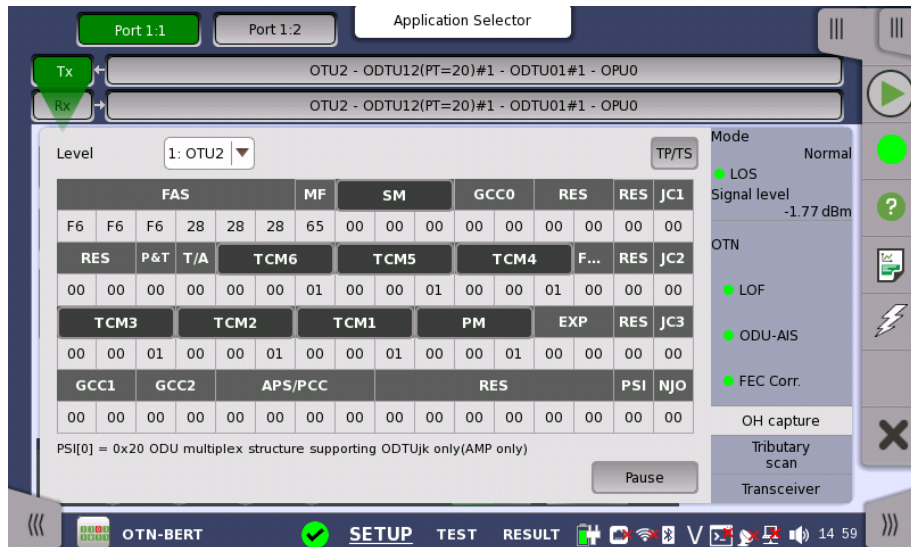

This screen shows OTU/ODU/OPU OH capture data for one frame at time. Use the **Level** drop-down menu to select which multiplexing level to display. For a description of the frame structure, see the [Overhead Dialog box](#) section under the ports setup of OTN.

If higher order layer is mapped, **TP/TS** button appears. Touching **TP/TS** will launch the dialog box displaying tributary ports/slots of both Tx and Rx.

Refreshing information

Refresh once

When touch the **Pause** button, the **Update** button appears at left side of the **Pause** one and information is not updated. Touching the **Update** button will refresh the dialog information once.

Refresh continuously

When the dialog is open and touch the **Pause** button at refresh once mode, information is updated continuously.

Displaying detailed information

Detailed overhead byte information can be accessed by touching the name of a specific byte. This will launch a separate dialog box containing a description of and details about the selected byte.

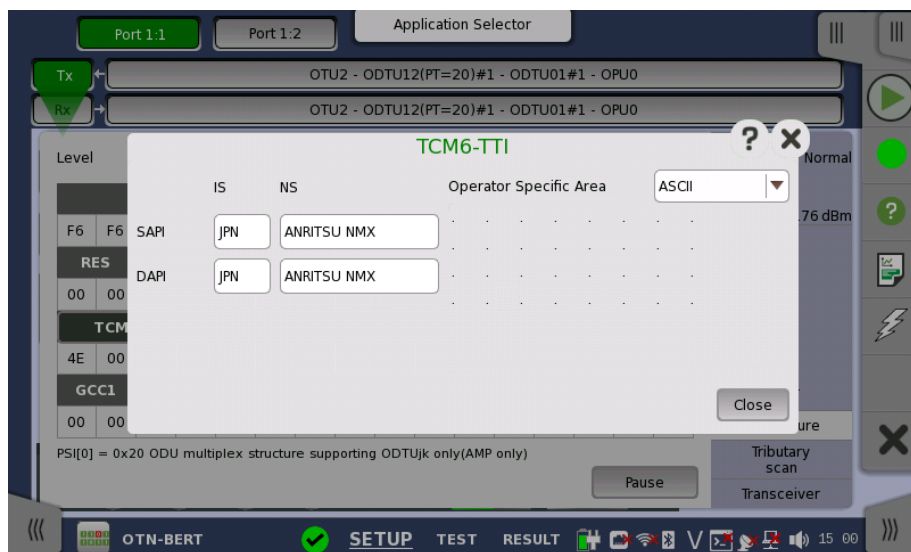

In the byte-specific dialog box, select the display format (ASCII or Hex) using the **Operator Specific Area** drop-down menu.

7.1.3.5 Tributary scan

Touching the **Tributary scan** button in the status area of the **Ports Setup** screen displays the status shown below.

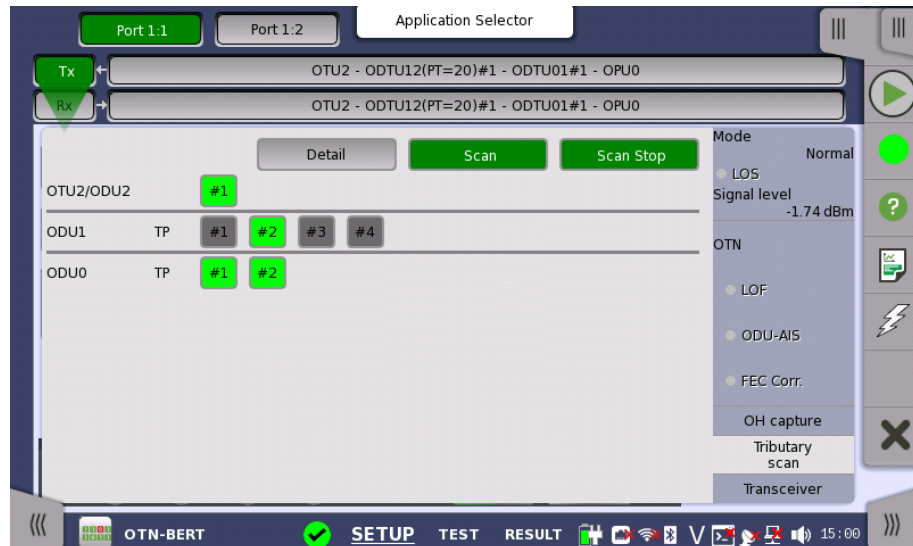

A *Tributary scan* detects errors and alarms over multiple Tributary Ports depending on the current mapping settings at the receiver port. The screen displayed by the **Tributary scan** button can be used to acquire the tributary status information.

The screen contains the following buttons: **Detail**, **Scan**, **Scan Start/Stop**. The **Scan** button is active when the screen is displayed.

Start scanning

Touching the **Scan Start** button scans one level at a time. With the **Scan** button active (displayed in green), you can select the Tributary Port to scan by touching the number button. The buttons are shown in green or red according to the scan result. Note that only one ODUk at the first level is displayed.

Detail

Touching the **Detail** button enables showing details for a specific ODUk. With the **Detail** button active, you can see the detail information by touching the button in red. The **Tributary details** dialog box contains the following information:

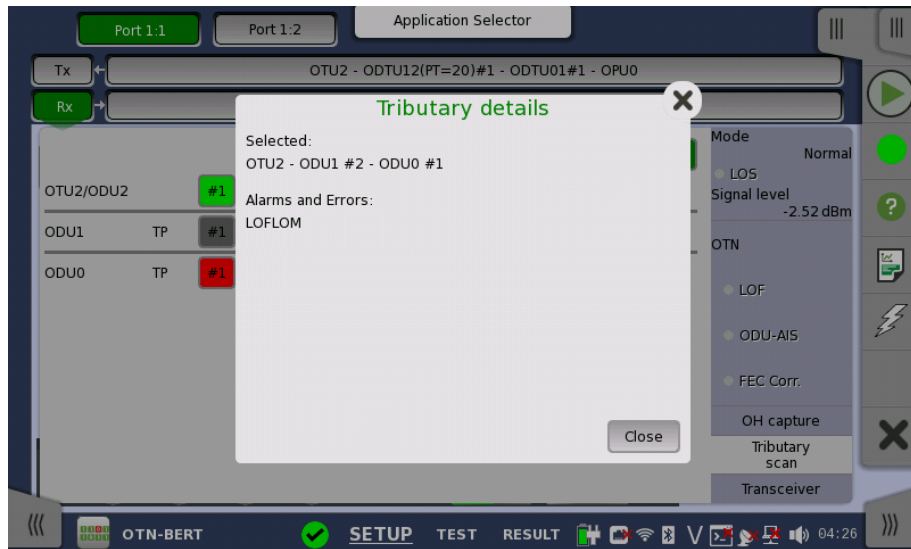

- Path to the selected form (for example, "ODU2-ODTU12(PT=21)-ODU1 #2")
- Errors and alarms detected at the selected channel.

Touching the button in green does not launch the dialog box.

To change TP to scan, touch the **Scan** button.



Tributary Scan Results are cleared, when close the dialog box, move other status area or move other screens.

Stop scanning

Touching the **Scan Stop** button stops the scanning session.

7.1.3.6 Transceiver

Touching the **Transceiver** button in the status area of the **Ports Setup** screen displays the status shown below.

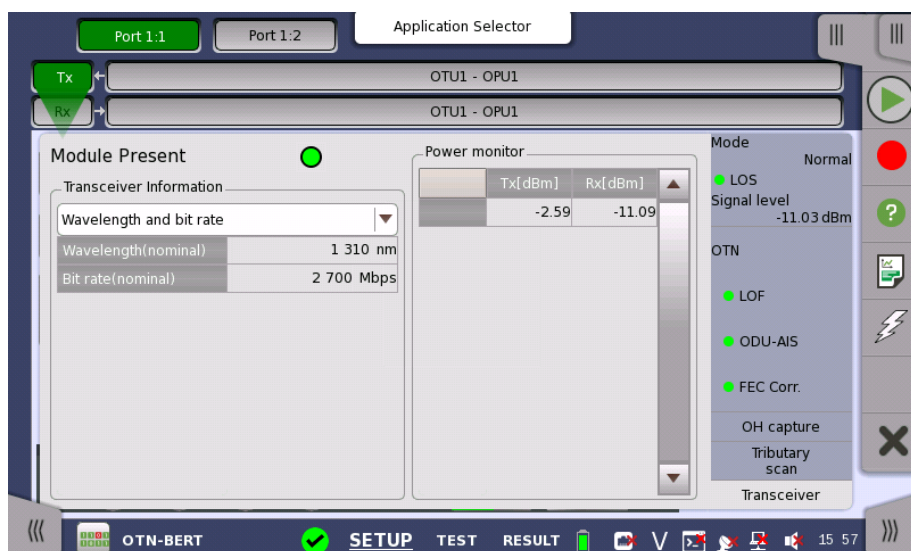

This screen presents status information about the optical transceiver.

When the optical transceiver is SFP or SFP+, [I2C analysis](#) appears. Refer to description of [Transceiver](#) in Ethernet Applications.

When the optical transceiver is QSFP+ or QSFP28, [I2C analysis](#) and [Settings](#) appear.

When the optical transceiver is CFP4, [MDIO analysis](#) and [Settings](#) appear.

Module Present

Green indicates that an optical transceiver is currently mounted.

Transceiver Information

Select the information from pull down menu.

- **Wavelength and bit rate** shows the nominal wavelength and bit rate.
- **Compliance** shows the available standards.
- **Vendor information** shows the data stored in the optical transceiver.

Tune wavelength

When the optical transceiver is a tunable SFP, following items are displayed for **Wavelength and bit rate**.

Bit rate, Channel, Wavelength, Frequency, First frequency, Last frequency, Grid spacing

Transceiver Information	
Wavelength and bit rate	
Bit rate(nominal)	11 300 Mbps
Channel	36
Wavelength	1552.50 nm
Frequency	193.1000 THz
First frequency	191.3500 THz
Last frequency	196.1000 THz
Grid spacing	50.0 GHz

Touching **Channel** or **Wavelength** value opens the dialog box to set the wavelength.

Power monitor

The optical power read out from the transceiver is displayed.

The transmitting optical power is displayed in left column. The received optical power is displayed in right column.

7.1.4 Error/Alarm Insertion

This section describes the errors or alarms insertion for the OTN layer on the [Application toolbar](#).

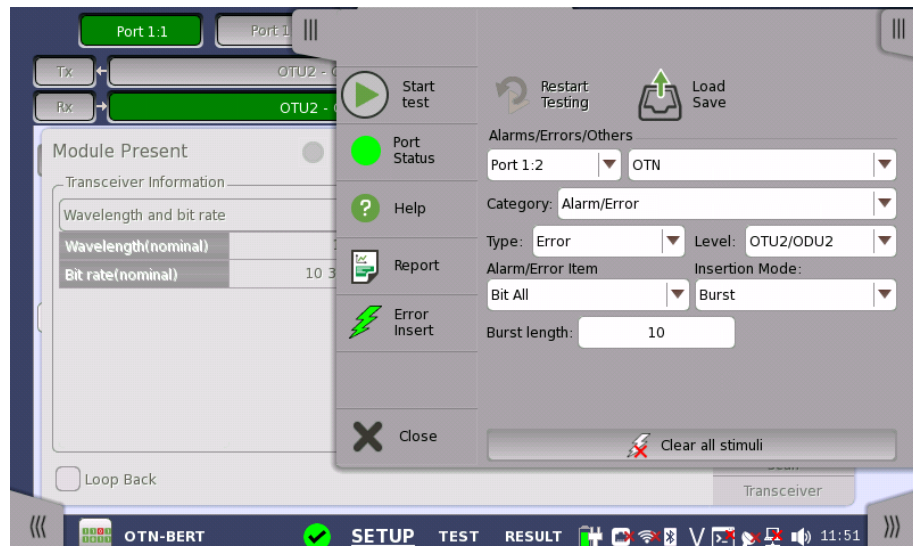

**Alarms/Errors/
Others**

Select the port to insert errors, and the stimuli type. The settings items vary depending on the selected stimulus type.

- **OTN:** Inserts errors or alarms related the OTN overhead or FEC.
- **OTN OTL skew:** Inserts skew between specified lanes.
- **OTN frequency:** Adds the frequency offset to the OTU bit rate and Payload bit rate.
- **OTN justification:** Inserts positive or negative justification bytes of AMP (asynchronous mapping procedure).

7.1.4.1 OTN

If selecting **OTN**, the **Category** drop down menu appears.

- **Alarms/Errors:** Inserts errors or alarms related the OTN overhead.
- **GMP:** Inserts errors to the general mapping procedure parameter.
- **GFP:** Inserts errors to the generic framing procedure parameter.
- **FEC Test:** Inserts errors to the forward error correction bytes in the OTU frame.
- **OTL:** Inserts errors or alarms to the specified lanes.

Alarms/Errors

1. Select **Alarm** or **Error** using **Type** drop down menu. If selecting **Off**, Errors and Alarms are not inserted.
2. Select the **Level**.
3. Select the **Alarm/Error Item**.
4. Select the **Insertion Mode**.
 - **Single:** Inserts an error or an alarm if you touch the Error Insert icon.
 - **Burst:** Inserts errors or alarms in counts you have specified if you touch the Error Insert icon.
 - **Alternate:** Repeats error/alarm insertion per specified number of frames. The Error Insert icon shows only status.
 - **All:** Inserts errors or alarms in all OTU frame. The Error Insert icon shows only status.
 - **Rate:** Inserts errors in the specified rate continuously. The Error Insert icon shows only status.
5. When selecting **Single** or **Burst**, touch the Error Insert icon () to insert errors or alarms.

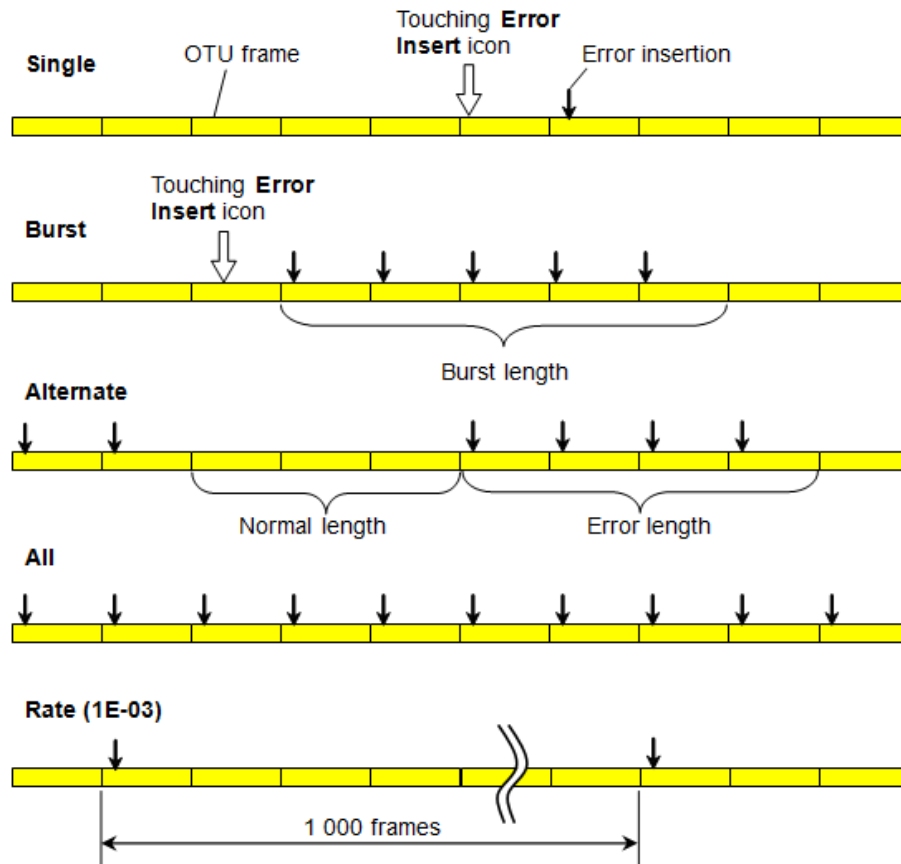

GMP

1. Select the **Level** to insert errors.
2. Select the **Error Item**.
3. Touch the **Error Bits** field to edit bits.
4. Touch the **Error Insert** icon. The error is inserted once by touching the icon.

GFP

1. Select the **Error Item**.
The available option depends on the Client Signal of Mapping.
2. Select the **Insertion Mode**.
3. Touch the **Error Bits** field to edit bits.
4. If Insertion Mode is set to "Single", touch the **Error Insert** icon. The error is inserted once by touching the **Error Insert** icon.

FEC Test

1. Select the **Error Item**.
 - o O.182 Poisson (appears only if Client Signal is PRBS.)
 - o Uncorrectable Error
 - o Correctable Error
2. When selecting O.182 Poisson:
 - a. **Insertion Mode** is fixed to "Rate".
Touch the **Rate** field to set the error insertion rate.
 - b. Select the **Exclude FAS**.
Selecting **On** inserts errors at any position excluding FAS when the rate is 2.0E-3 or larger. This settings avoids the occurrence of LOF by inserting errors into FAS.
3. When selecting Uncorrectable Error or Correctable Error:

- a. Touch the **Sub-row** field to set the sub-row.
- b. **Insertion Mode** is fixed to "Single".
Touch the **Error Insert** icon. The error is inserted once by touching the icon.



For O.182 Poisson, refer to the white paper on Anritsu homepage:
[FEC Efficiency New Test Method - Required by ITU-T New Rec. O.182 -](#)

OTL

1. Select the **Type**.
2. Select the **Alarm Item** or **Error Item**.
3. Select the **Insertion Mode**. When setting to "Burst", touch **Burst** field and set value. When setting to "Alternate", touch **Error length**, **Normal length** fields and set values.
4. Touch the buttons of **Lane**, the dialog box will appear.
5. Touch the buttons to select/clear lanes. The errors will be inserted to selected (orange) lanes.

7.1.4.2 OTN OTL skew

1. Touch the field below the port selection to set the number of skew bits. The calculated skew time is shown below the field.
2. When the output signal is set to OTU4, select the **Lane type**.
3. Touch the buttons of **Insertion Lanes**, the dialog box will appear.
4. Touch the buttons to select/clear lanes. The skew will be inserted between selected (orange) lanes and non selected (gray) lanes.

Setting to "0" means that inserting no skew.

7.1.4.3 OTN frequency

Touch the field to set **Frequency Offset**. If setting a positive value, the frequency will shift higher side.

Example:

If setting 100 ppm to the frequency offset for OTU2 output signal, the bit rate of output signal will be

$$10\,709\,225.316 * (1 + 100 * 10^{-6}) = 10\,710\,296.239 \text{ (kbit/s)}$$

Nominal bit rates defined in ITU-T are shown below.

OTU type	OTU nominal bit rate (kbit/s)
OTU1:	$255/238 * 2\,488\,320 = 2\,666\,057.143$
OTU2:	$255/237 * 9\,953\,280 = 10\,709\,255.316$
OTU1e:	$255/238 * 10\,312\,500 = 11\,049\,107$
OTU2e:	$255/237 * 10\,312\,500 = 11\,095\,730$
OTU1f:	$255/238 * 10\,518\,750 = 11\,270\,089$
OTU2f:	$255/237 * 10\,312\,500 = 11\,317\,642$
OTU3:	$255/236 * 39\,813\,120 = 43\,018\,413.559$
OTU3e1:	$255/236 * 4 * 10\,312\,500 = 44\,570\,974.576$
OTU3e2:	$243/217 * 16 * 2\,488\,320 = 44\,583\,356$
OTU4:	$255/227 * 99\,532\,800 = 111\,809\,973.568$

If low order ODU is mapped, **Payload Offset** field appears. Touch the field to set the payload offset. The calculated C_m and C_{nD} will be displayed when using GMP.

7.1.4.4 OTN justification

OTN justification is available when ODTUjk is selected to the [Multiplexing 1](#) in Mapping dialog box.

1. Select **Level** to insert the justification.
2. Touch the **Burst length** field, the dialog box will appear.
3. Select the **Movement** of the justification.
 - Positive (+1): positive justification
 - Positive (+2): double positive justification
 - Positive (+3): triple positive justification
 - Negative (-1): negative justification
 - Negative (-2): double negative justification
4. Touch the **Apply Move** button to insert the justification bytes.

7.2 APS



The APS (Automatic Protection Switching) test measures the switching time in protecting the system from failure

Switching time is defined below.

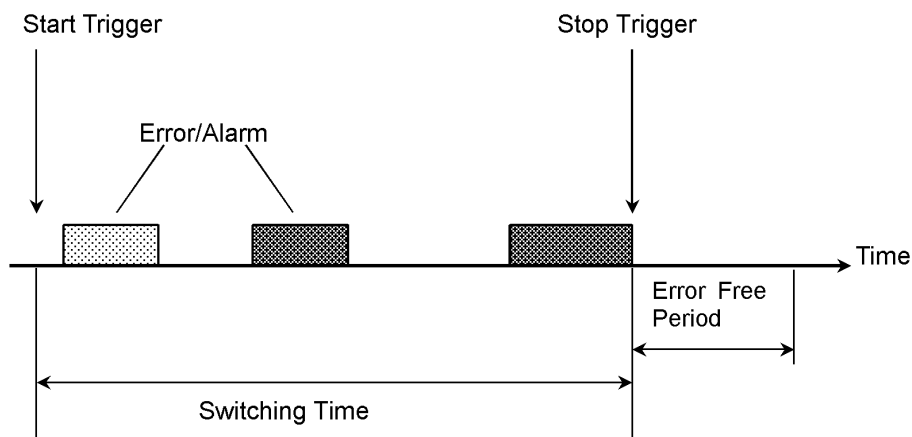

- The start and stop trigger can be selected independently.
- Trigger event can be selected from the high order OTU and ODU.
- The pass/fail thresholds for switching time can be set.
- Test results include pass/fail, switching time (minimum, maximum and average) and the measurement count of switching.

7.2.1 Ports Setup and Status

The first step in running an application is to set up the port interfaces. This is done on the **Ports Setup** screen, which also provides port status information.

The setup options and status information related to the OTN interface are described in the following section:

- [OTN Setup and Status](#)

7.2.2 Test Setup

7.2.2.1 Thresholds

The following screen is displayed for the **Test Setup**.

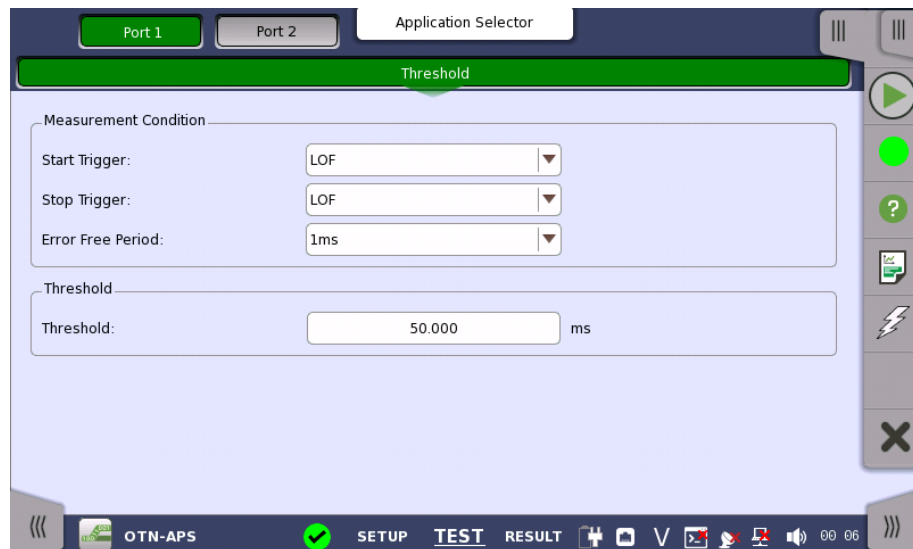

This screen contains the parameters for setting up the threshold values for errors and Pass/Fail status.

Start Trigger, Stop Trigger

Use the drop-down menu(s) to select the appropriate trigger. Start and stop triggers include the following:

Any errors, LOF, OOF, ODU-AIS etc.

If selecting **Any errors**, all alarms and errors displayed on the list are treated as the trigger.



*The errors which can be set as the Start Trigger and Stop Trigger do not contain all items listed in **Alarm/Error item** on Application Toolbar. For example, PM-TIM and OTU-FAS are not handled as a trigger even if **Any errors** is selected.*

Error Free Period

Alarms or Errors set up in stop trigger are not in a measured signal within the time of this cycle, end the switching time measurement.

Threshold

Allows you to specify the maximum duration of the selected trigger(s). Valid values are from **0.000 ms** to **10000.000 ms**.

7.2.3 Test Results

7.2.3.1 Summary

Touching the **Summary** button in the navigation area will display the screen shown below.



The following information is displayed:

- Start Trigger
- Stop Trigger
- Average switching time : Average time of switching
- Max. Time : Maximum time of switching
- Threshold : The threshold value used in the test

7.2.3.2 Detailed

Touching the **Detailed** button in the navigation area will display the screen shown below.

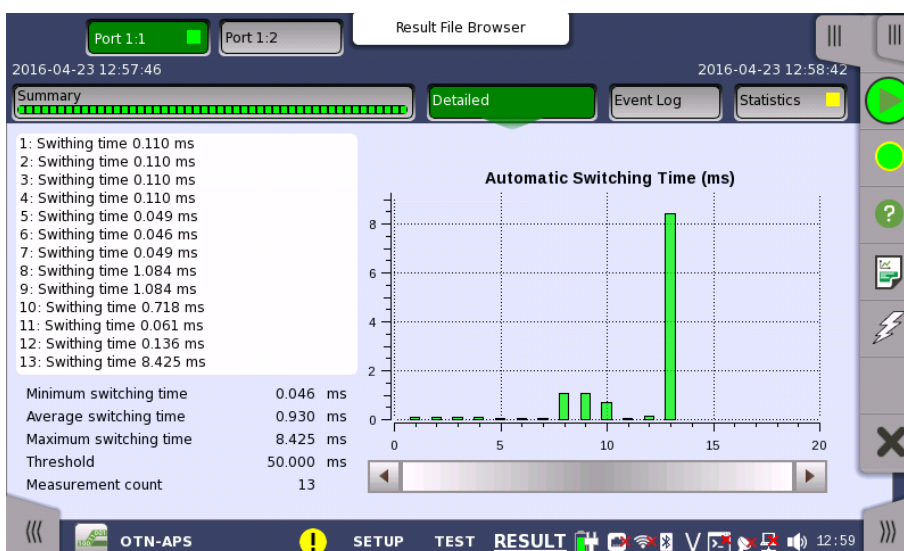

Buttons for selecting the relevant port are displayed at the top of the screen, with a color indication of the pass/fail status of the test.

This screen presents the detailed results of an OTN APS test. The results relate to a specific port and consist of the Automatic Switching times of the APS requests. The data is shown in both list-form and in a graphical presentation. This screen contains the summary field displayed below the list.

Summary field	Consists of the minimum, maximum, and average automatic switching times in milliseconds, the specified threshold value, the number of measurements.
List-form information	Presents the automatic switching times in list-form.
Graphical presentation	The graphical presentation consists of a bar diagram of the automatic switching times. Results affected by unexpected alarms/errors are indicated.

7.2.3.3 Event Log

Touching the **Event Log** button in the navigation area displays the screen providing the event log data. Refer to [Event Log](#) of SDH/SONET/PDH/DSn BERT application.

7.2.3.4 Statistics

Touching the **Statistics** button in the navigation area displays the screen providing the statistics data. Refer to [Statistics](#) of BERT for the operation.

7.3 BERT



The Bit Error Rate Test (BERT) described in this section is applicable for OTN interfaces.

7.3.1 Ports Setup and Status

The first step in running an application is to set up the port interfaces. This is done on the **Ports Setup** screen, which also provides port status information.

The setup options and status information related to the OTN interface are described in a separate section:

- [OTN Setup and Status](#)

7.3.2 Test Setup

7.3.2.1 Measurement Mode

Touching the **Measurement Mode** button in the navigation area displays the following screen.

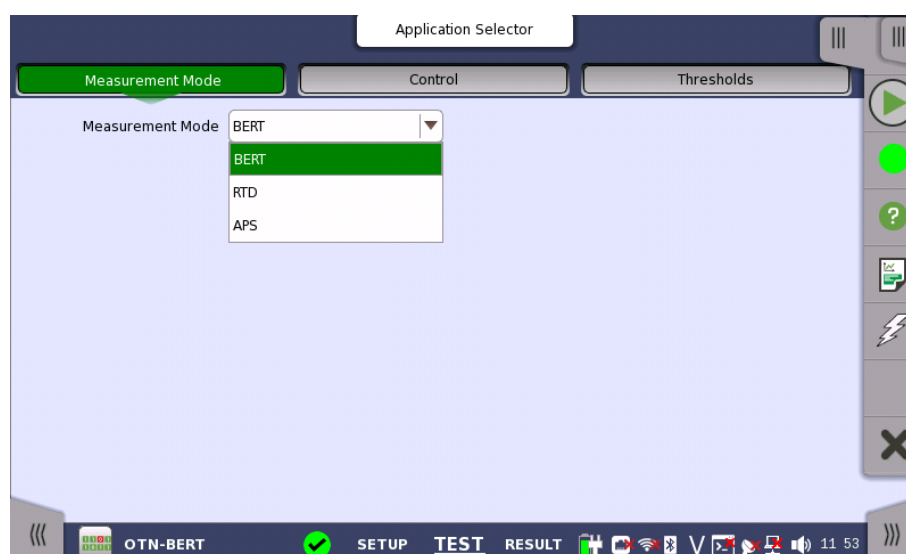

This screen allows users to switch the application.

Measurement Mode

Touch the field to select the application.

- BERT
- RTD
- APS



Measurement Mode button appears in the Navigation area only when starting the BERT by Application selector.

7.3.2.2 Control

Touching the **Control** button in the navigation area displays the following screen.

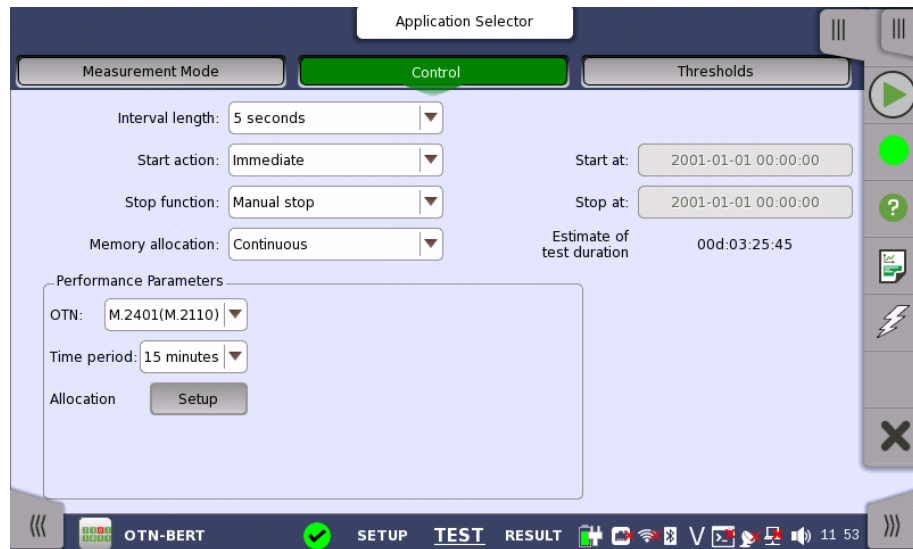

This screen allows you to configure the test mode and other general parameters related to the test.

Interval length

Allows you to specify the duration of the BERT intervals. The drop-down menu contains the following values: **1 second**, **2 seconds**, **5 seconds**, **10 seconds**, **15 seconds**, **30 seconds**, **1 minute**, **5 minutes**, **10 minutes**, **15 minutes**, **30 minutes**, **1 hour**, **2 hours**, **4 hours**, **6 hours**, **12 hours** or **No Intervals**.

Start action

Allows you to specify when the measurement is started.

- **Immediate**: Starts the measurement when you touch the **Start** button.
- **Start at**: Starts the measurement at the time specified in the **Start at** field on the right.

Stop function

Allows you to specify when the measurement ends. Select the relevant option from the drop-down menu:

- **Manual stop**: Stops the measurement immediately when you touch the **Stop** button.
- **Stop at**: Stops the measurement at the time specified in the **Stop at** field on the right.
- **Duration**: Performs the measurement for the duration of time specified on the right.

Memory allocation

Allows you to specify how the measurement will be stored in the Network Master's memory. Select the relevant option from the drop-down menu:

- **Use all storage**: When Network Master's memory became full of measured data, the whole measurement is stopped.
- **Continuous**: When Network Master's memory became full of measured data, the oldest records in that memory will be overwritten. When the memory became full, it is recorded in [Event log](#).

The Network Master's memory size (the file size of measurement results) is 64 Mbytes per one port. The result file size is less than 64 Mbytes because it is compressed when saving to the file.

Estimate of test duration

Contains an estimation of the time (in days, hours, minutes and seconds) before the whole memory will be filled out by the test. During an ongoing measurement, the estimate will be recalculated periodically.

Performance Parameters

OTN

Select the ITU-T Recommendation applying to the test.

- **G.8201** Error performance parameters and objectives for multi-operator international paths within the Optical Transport Network (OTN)
- **M.2401 (M.2110)**
 - M.2401** Error performance limits and procedures for bringing-into-service and maintenance of multi-operator international paths and sections within an optical transport network
 - M.2110** Bringing into service international multi-operator paths, sections and transmission systems

Time period

This parameter is displayed if *OTN* is set to M.2401(M.2110).

15 minutes, 1 hour, 2 hours, 24 hours, 7 days

Allocation

Touching the **Setup** button launches the dialog box shown below.

The dialog box is used to set up various performance parameters.

Type

Select the performance type as either **G.8201** or **M.2401/M.2110**. The contents of the dialog box depends on the selected performance type.

Allocation

Set the Allocation ratio of OTUk, ODUk or TCMi. These parameters are displayed if *Type* is M.2401/M.2110.

Section Objective (SESR)

Set the limit of SESR (Severely Errored Seconds Ratio). SES (Severely Errored Second) is a one-second period which contains 15% or more errored blocks or at least one defect.

Section Objective (BBER)

Set the upper limit of BBER (Background Block Errors Rate). BBE (Background Block Error) is an errored block that occurred during non-SES.

The performance objectives defined in ITU Recommendation are shown in the following table.

Performance Objectives

Path type	G.8201		M.2401	
	SESR	BBER	SESR	BBER
ODU1	0.002	4×10^{-5}	0.001	2×10^{-5}
ODU2	0.002	10^{-5}	0.001	5×10^{-6}
ODU3	0.002	2.5×10^{-6}	0.001	1.25×10^{-6}

7.3.2.3 Thresholds

Touching the **Thresholds** button in the navigation area displays the following screen.

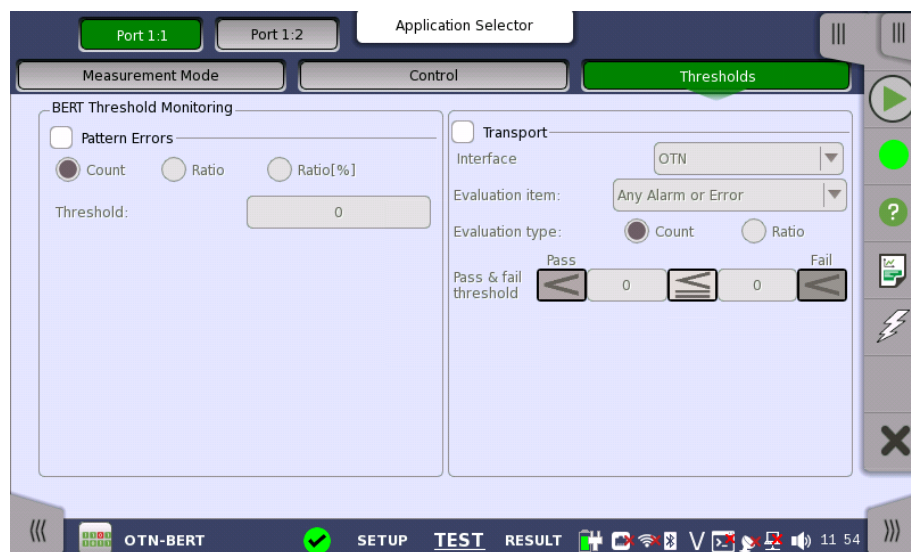

This screen contains the parameters for setting up the various threshold values (i.e. limits) for errors and Pass/Fail status that are used during the monitoring.

Pattern Errors

Allows you to enable monitoring of pattern errors (i.e. bit errors) and to set up a threshold value for the bit error ratio. Select the check box to enable the parameters.

Choose whether the threshold is specified as an absolute value or a percentage, using the **Count**, **Ratio** and **Ratio [%]** radio buttons, and then specify the value in the **Threshold** field.

Transport

Select the check box to enable the transport-related parameters.

Interface

Fix to OTN.

Evaluation item

Use the drop-down menu to select the item to evaluate. If selecting other than **Any Alarm or Error**, another menu appears.

Evaluation type

Select the relevant type.

Pass & fail threshold

Touch the left-hand number to set the lower limit for "Warning". Touch the right-hand number to set the lower limit for "Fail". The lower limit of "Fail" must be equal to or greater than the lower limit of "Warning" (defining a "Within limits" range in between them).

7.3.3 Test Results

7.3.3.1 Summary

Touching the **Summary** button in the navigation area will display the screen shown below.

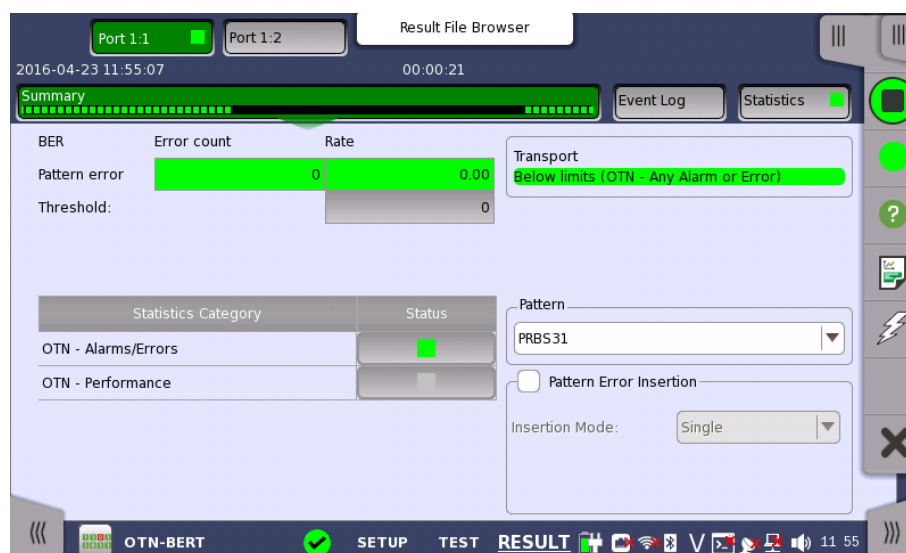

This screen shows the summary of all error count and ratio. You can insert the pattern error in this screen.

BER

Displays the result of pattern errors and threshold.

Statistics Category

The lamp icon in Status column shows the Pass or Fail results. Touching the Status column displays the statistics results.

Transport

Displays the result of Pass & fail threshold if Transport is selecting in **Test Setup** screen.

Pattern

Select the pattern. You can edit bit pattern when the pattern is User[32] bit or User[2048] bit.

Pattern Error Insertion

Select the check box to enable the pattern error insertion.

Select Insertion Mode to **Single** or **Rate**. When **Single** is selecting, touch Alarm/Error Insert icon in the Application Toolbar.

7.3.3.2 Event Log

Touching the **Event Log** button in the navigation area displays the screen providing the event log data. Refer to [Event Log](#) of SDH/SONET/PDH/DSn BERT application.

7.3.3.3 Statistics

Touching the **Statistics** button in the navigation area displays the screen shown below.

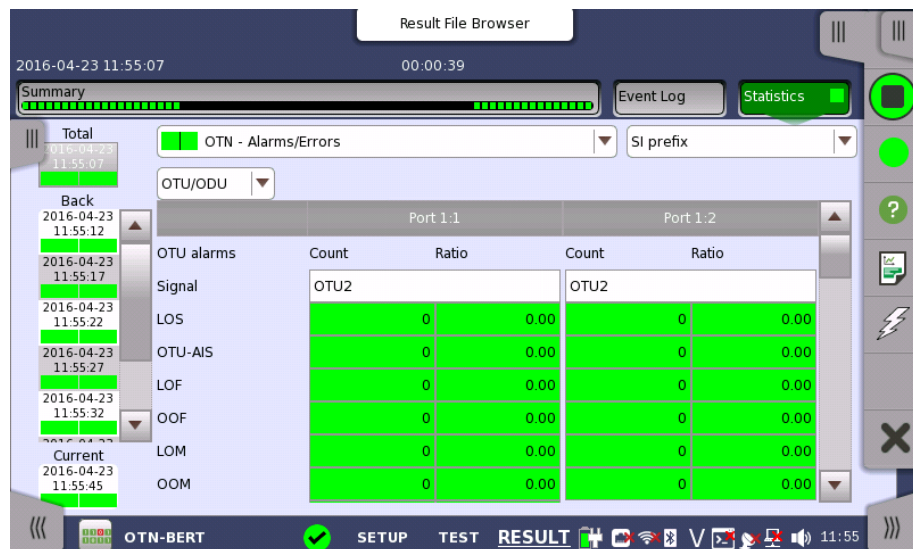

This screen presents a detailed analysis of the test results. You can choose to view either the current results (i.e. results measured during one second) or the total results from measurement start. You can also zoom in on a specific result item. The results can be displayed either in table (list) form or as a graph.

Selecting which results to view

Selecting the interval time

Touch the **Total** button to switch the total values measured in all interval times. The start time of measurement is displayed on the button.

Touching the button in left side **Back** field shows the measured values in the interval time. The end time of the interval is displayed on the button.

Current button is displayed at left bottom when the measurement is running. Touching the **Current** button shows the measured values in the current interval time. The start time of the current interval is displayed on the button.

The slide-out panel on the left-hand side of the screen contains the following functions:

- Only show intervals that contains errors
- Time format

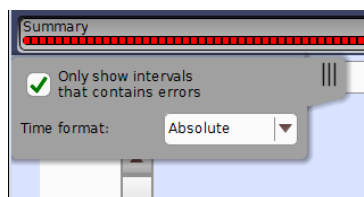

*If you have stopped measurement during the interval time, the measurement results of the current interval are discarded. The log of the current interval is not displayed in **Back field**.*

In this case, result data are re-calculated excluding the data of the current interval when the measurement is stopped. This causes that "Count" and "Ratio" displayed after the measurement will be different from that of during measurement.

The sum of interval time (multiplied interval time by the number of back logs) may not match the differential time between displayed time at left top and right top after the measurement.

Selecting type of results

Open the drop-down menu in the top row plus the drop-down menu below it to select which results you want to display on the screen.

- OTN - Alarms/Errors
- [OTN - Performance](#)

Selecting how results are displayed

Selecting notation

Select the required notation for the results from the notation drop-down menu.

- **Unformatted** e.g. 71892
- **SI prefix** e.g. 71.892 k (k means "kilo")
- **Engineering** e.g. 71.892E3
- **Scientific** e.g. 7.1892E4

Results

OTN - Alarms/Errors	OTU/ODU	OTU alarms OTU errors ODU alarms ODU errors
	Stage1 ODU	ODU alarms ODU errors
	Stage2 ODU	ODU alarms ODU errors
	Stage3 ODU	ODU alarms ODU errors
	Client	Client alarms Client errors
	ODU TCM	ODU TCMi alarms ODU TCMi errors
	Justification	
	GFP	

	OTL	OTL Alarms/Errors Alignment marker Lane skew
OTN - Performance	OTU/ODU	OTU ODU
	Stage1 ODU	ODU
	Stage2 ODU	ODU
	Stage3 ODU	ODU
	ODU TCM	TCMi

OTN Performance Measurement Items

This paragraph describes the performance result items.

EB (Errored Block) is defined as:

A block in which one or more bits are in error

OTN Performance Parameters

Items	Definition	
SES	Severely Errored Second Count: The number of seconds during which 15% or more EBs occurred or one or more alarms were detected. Ratio: Ratio of SES to total seconds in availability time (SESR: Severely Errored Second Ratio)	
	OTU/ODU, Stage n ODU <ul style="list-style-type: none"> • OCI • AIS • LCK • PLM • TIM • BDI 	ODU/TCM <ul style="list-style-type: none"> • OCI • AIS • IAE • LCK • LTC • TIM • BDI
BBE	Background Block Error Count: EBs that excludes blocks which are determined as SES. Ratio: Ratio of BBE to all blocks excluding blocks in SES (BBER: Background Block Error Ratio)	
UAS	Unavailable Time When SES continues for ten seconds, UAS starts from the beginning of the time. When items other than SES continues for ten seconds, UAS ends at one second before the time. Refer to the figure of Example of Unavailable Time Detection . First, the time (when determining the start of UAS) is not counted as UAS, and then if determined, the UAS is recounted. First, the time (when determining the end of UAS) is counted as UAS, and then if determined, the UAS is recounted. In a word, the values of UAS may be reduced later. The same is applied to other items. A bidirectional UAS is counted if forward, backward, or both directions are in the unavailable state.	

Example of Unavailable Time Detection

Pass/Fail is judged after the Time period set at [Performance Test Parameters](#) on the Control screen has elapsed.

7.4 RTD



The Round-Trip Delay (RTD) time is the duration time of the network and the network equipments.

Network Master measures RTD using a trigger injected in ODU frame. At first, Network Master transmits the trigger signal. Network Master measures the RTD by receiving the trigger signal returned from the network to be measured or the network equipment.

7.4.1 Ports Setup and Status

The first step in running an application is to set up the port interfaces. This is done on the **Ports Setup** screen, which also provides port status information.

The setup options and status information related to the OTN interface are described in a separate section:

- [OTN Setup and Status](#)

7.4.2 Test Setup

7.4.2.1 Control

When you go to the test setup of the RTD application, the following screen is displayed.

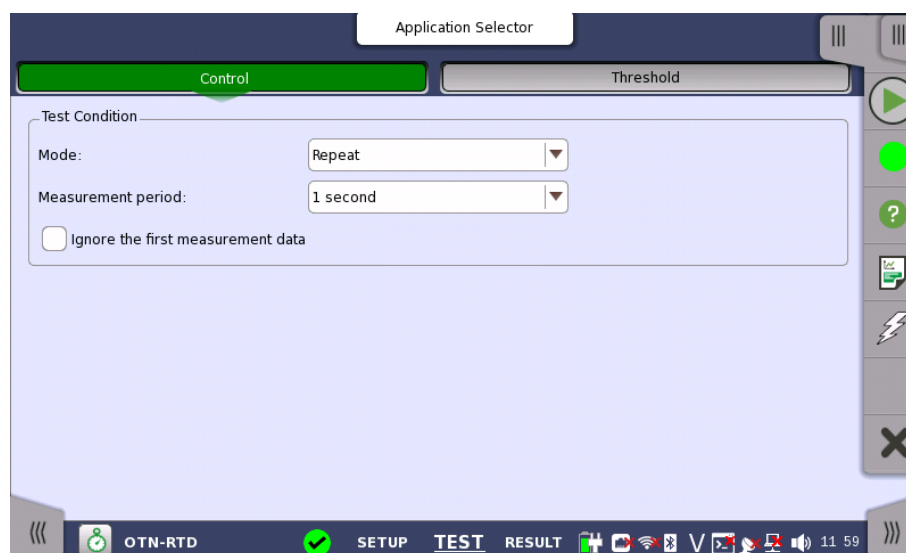

This screen allows you to configure the *RTD test* conditions for the currently selected port(s).

Test Condition

Mode

Allows you to define the test duration in one of two ways:

- **Single** - Used to perform RTD test once.
- **Repeat** - Used when a *persistent RTD test* is needed.

Measurement period

Measurement period can be set the maximum RTD per one Test.

7.4.2.2 Threshold

Touching the **Thresholds** button in the navigation area displays the following screen.

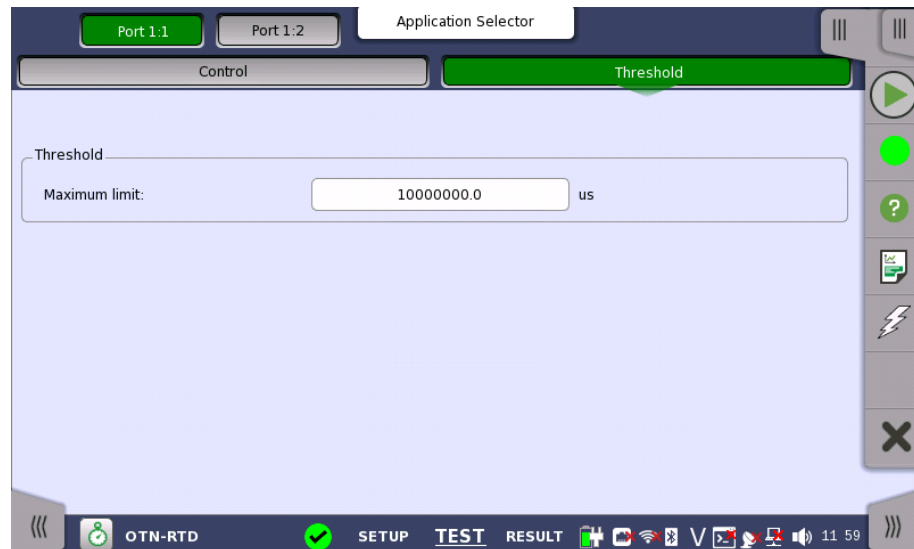

This screen allows you to configure the *RTD test* conditions for the currently selected port(s).

Threshold

Maximum limit

Allows you to specify a threshold value of RTD in micro seconds (μs).

7.4.3 Test Results

7.4.3.1 Summary

Touching the **Summary** button in the navigation area will display the screen shown below.



This screen presents a summary of the RTD test results, for all of the ports included in the test. For each port, the information consists of:

- The total number of measurements

- Minimum, Average and Maximum RTD in micro seconds
- Threshold value

7.4.3.2 Detailed

Touching the **Detailed** button in the navigation area will display the screen shown below.

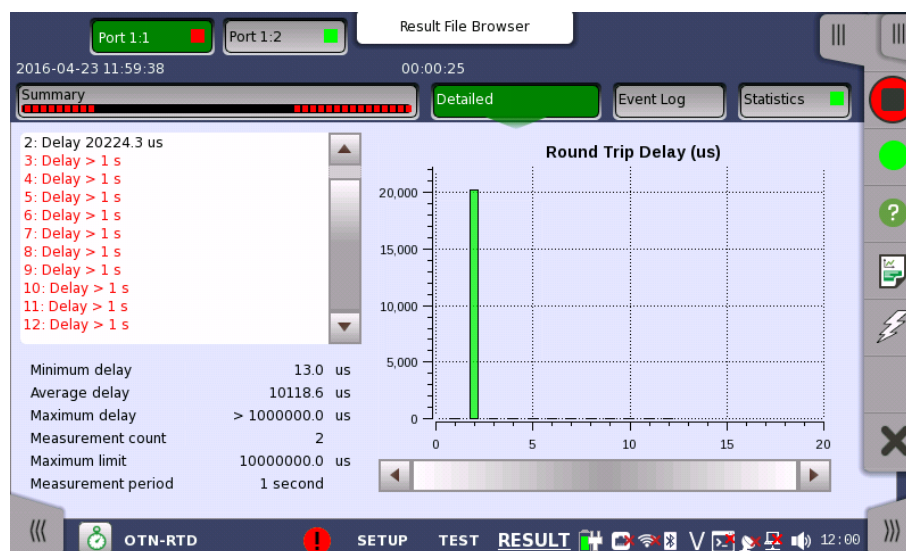

Buttons for selecting the relevant port are displayed at the top of the screen, with a color indication of the pass/fail status of the test.

This screen presents the detailed results of an RTD test. The result is shown in both list-form and in a graphical presentation. This screen contains the summary field displayed below the list.

Summary field

Consists of the minimum, maximum, and average round-trip delay times in micro seconds, the number of measurements, the specified threshold value and measurement period.

List-form information

Presents the results of an RTD test in list-form.

Graphical presentation

The graphical presentation consists of a bar diagram of the round-trip delay times.

7.4.3.3 Event Log

Touching the **Event Log** button in the navigation area displays the screen providing the event log data. Refer to [Event Log](#) of SDH/SONET/PDH/DSn BERT application.

7.4.3.4 Statistics

Touching the **Statistics** button in the navigation area displays the screen providing the statistics data. Refer to [Statistics](#) of BERT for the operation.

8 Mobile xHaul Applications

This chapter describes the graphical user interface (i.e. screens, sub-screens and major dialogs) related to applications used for Mobile communication interface. Sub-screens and dialogs are described under the main screen from which they are activated/launched.

The following applications are available:

- [CPRI/OBSAI BERT](#)
- [CPRI P. Through](#)
- [eCPRI/RoE BERT](#)

8.1 CPRI/OBSAI Setup and Status

CPRI (Common Public Radio Interface) is an interface designed for the communication inside the base station used for the mobile radio communications.

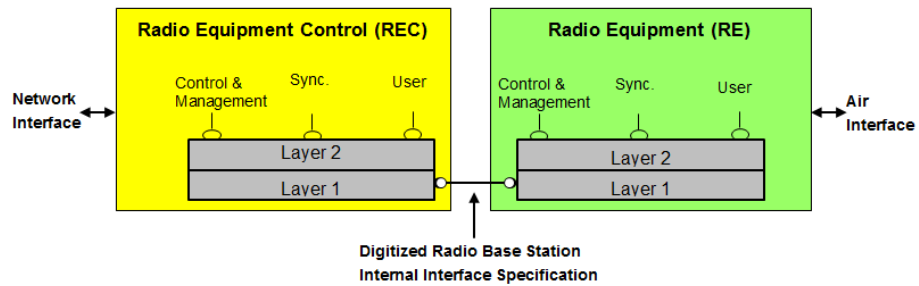

OBSAI (Open Base Station Architecture Initiative) defines the architecture of the cellular base station, including the interface between base band block and RF block. In the OBSAI specifications, this interface is defined as **RP3** (Reference Point 3).

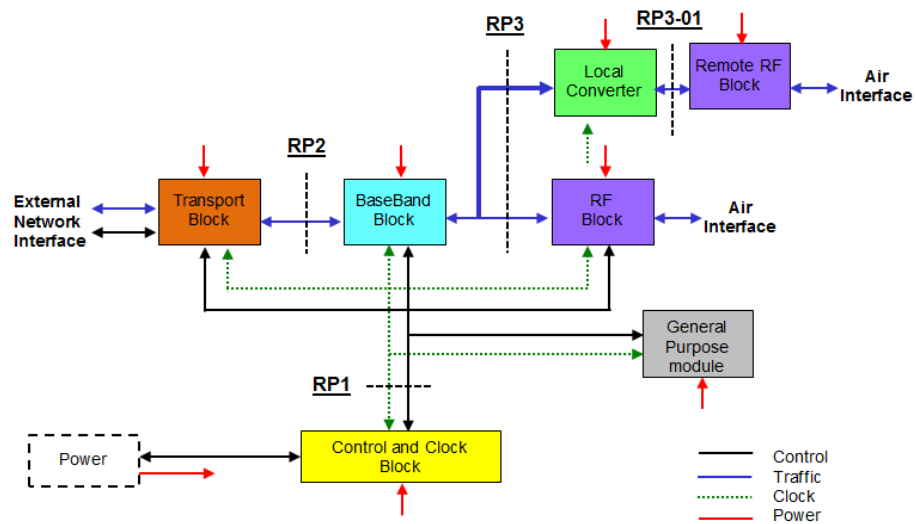

The nominal bit rates of CPRI and OBSAI are shown in the following table.

CPRI Line bit rates

Option	Bit Rate (Mbit/s)	Multiplier × Reference bit rate × Coding (Mbit/s)
1	614.4	$1 \times 491.52 \times 10/8$
2	1228.8	$2 \times 491.52 \times 10/8$
3	2457.6	$4 \times 491.52 \times 10/8$
4	3072.0	$5 \times 491.52 \times 10/8$
5	4915.2	$8 \times 491.52 \times 10/8$
6	6144.0	$10 \times 491.52 \times 10/8$
7	9830.4	$16 \times 491.52 \times 10/8$
8	10137.6	$20 \times 491.52 \times 66/64$
9	12165.12	$24 \times 491.52 \times 66/64$
10	24330.24	$48 \times 491.52 \times 66/64$

OBSAI Line bit rates

Bit Rate (Mbit/s)	Multiplexer × Base bit rate (Mbit/s)
768	1×768
1536	2×768
3072	4×768
6144	8×768



The CPRI/OBSAI uses the optical ports.



MU100010A Connector Panel



MU100011A Connector Panel

8.1.1 Physical Port Setup

When the port is set up with a CPRI/OBSAI interface, touching the **Port** button in the navigation area will display the following screen.

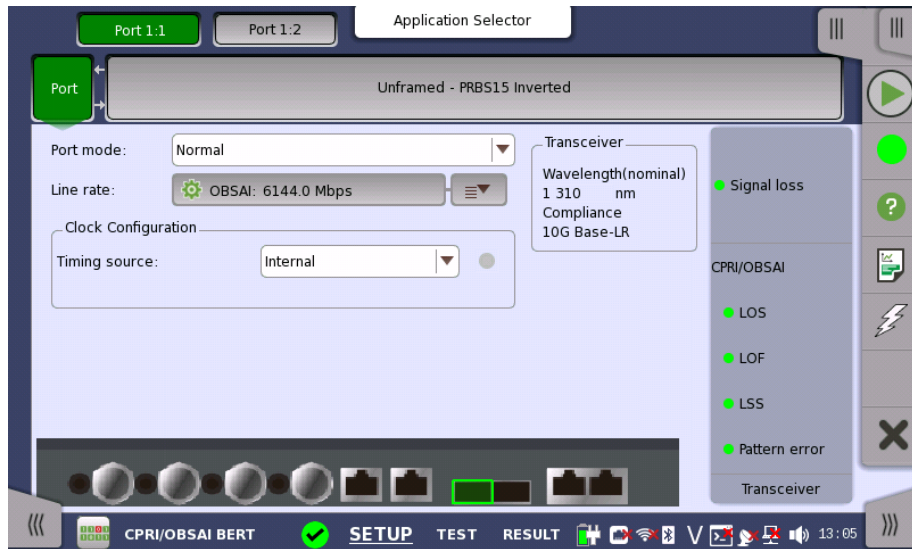

This screen allows you to specify the physical port configuration of the currently selected CPRI/OBSAI port. It can also be used to inspect the current status of the selected port.

Port mode

Select the port mode from the drop-down menu. The possible values are:

- **Off:** The transmission will be disabled.
- **Normal:** The Network Master generates and transmits the signals.
- **Through:** This option is available when Contents in the CPRI/OBSAI frame setting is set to **CPRI link**. If **Through** is selected when Contents is set to **Unframed** or **OBSAI link**, Contents is forced to set to **CPRI link**.

Line rate

Left-side button: Opens the **Line Rate Setup** dialog box.

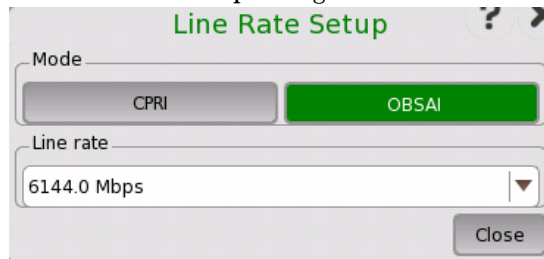

Touch **CPRI** or **OBSAI** and select a line rate. Select the bit rate of the line from the drop-down menu.

Right-side button (☰): Displays the *quick setup menu*.

Clock Configuration

Use the drop-down menu to select the clock source. This is fixed to **Received** when the Port mode is set to **Through**.

Timing Source

- Internal:** Internal clock of the module
- External:** The clock input to the connector
- GPS:** The clock provided from the external GPS sensor
- Received:** The clock generated from the received signal

When **External** or **Received** is set, the indicator on the right is on if the clock is detected.

- FEC** The **FEC enable** checkbox is available if **Line rate** is set to CPRI 12165.12 Mbps or CPRI 24330.24 Mbps.
If this check box is selected, Reed-Solomon Forward Error Correction is applied to 64B/66B encoded CPRI blocks.
- Transceiver** Displays the Transceiver information.

8.1.2 CPRI/OBSAI Frame Setup

The **Unframed**, **CPRI Link** or **OBSAI Link** button appears in the navigation area. Touching the button will display the screen to set frame contents.

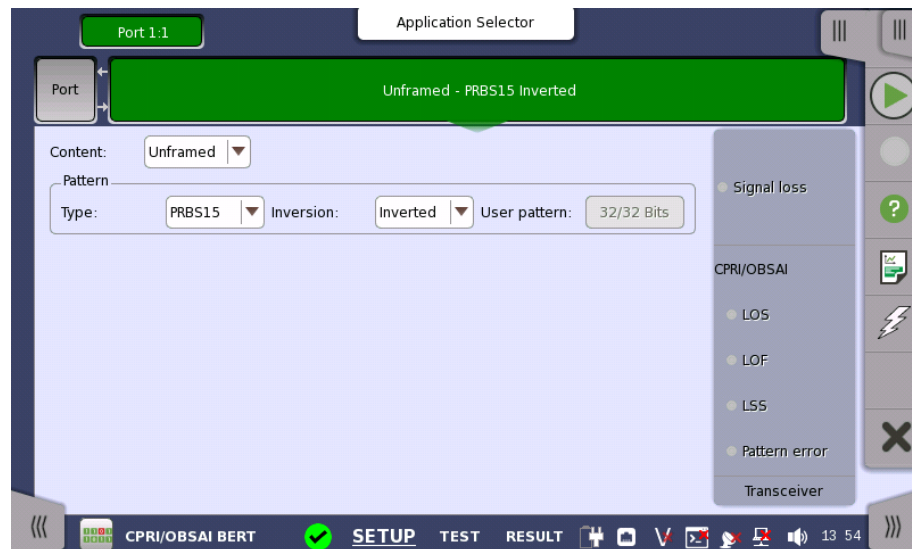

This screen allows you to specify the frame structure of the currently selected port.

The configuration options available in the setup area of the screen are described below. The status information is described in a separate section.

- Content** Select the frame type. Available options depend on the Line rate setting.
- **Unframed:** Pattern data without frame.
 - **CPRI Link:** CPRI frame structure
 - **OBSAI Link:** OBSAI frame structure

Pattern Select a predefined pattern or define a user pattern.

Type

- **PRBS15 to PRBS31:** Pseudo-random bit sequence. The number indicates the bit length of sequence.
For example, bit length of PRBS15 is $2^{15}-1=32767$.
- **User [32] bit:** Pattern of 32-bit length.
You can edit the pattern by touching the **User pattern** field.
This option is not available when Content is set to **Unframed**.
- **Off:** No patterns are transmitted.
This option is not available when Content is set to **Unframed**.

Inversion

Select whether or not to invert the bit pattern when Type is set to **PRBS15** to **PRBS31**.

User pattern

This is enabled when Type is set to **User [32] bit**.

Touch the field to open the dialog box where you can define the bit pattern.

Refer to [The User Pattern Editor](#).

CPRI Link

Set the CPRI Link conditions, if **Content** is set to "CPRI Link" and **Port mode** is set to "Normal".

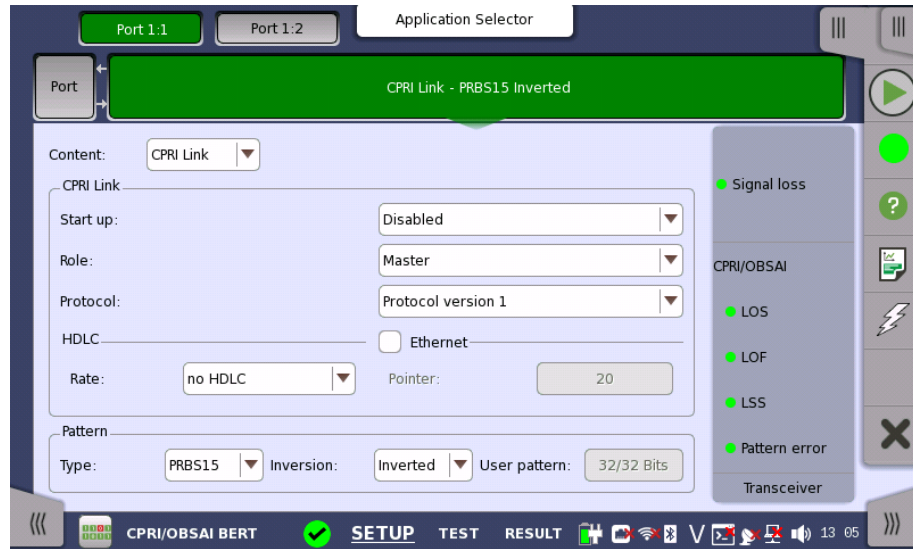

Start up

- **Enabled:** The line rate, protocol version, and C&M Channel will be decided by auto-negotiation. You can confirm the negotiated settings in Link of the status information.
- **Disabled:** The specified line rate, protocol version, and C&M Channel are applied.

Role

Select the port role from **Master** or **Slave**.

Timing setting will be changed to "Received" if setting to Slave.

Protocol

If Start up in CPRI Link is set to **Disabled**, select the CPRI Protocol version from 1 or 2.

Protocol version 2 appears if the line rate is set to 4915.2 Mbps or more.

HDLC

Touch the drop-down menu to specify the **Rate** of slow C&M Channel.

Options depend on the line rate.

Ethernet

Select the check box if setting fast C&M Channel.

Touch the field to specify the **Pointer**. To set maximum Ethernet bit rate, set "20" to the pointer. Actual Ethernet bit rate is proportional to the line rate excluding 10137.6 Mbps.

OBSAI Link

Set the OBSAI Link conditions, if **Content** is set to "OBSAI Link" and **Port mode** is set to "Normal".

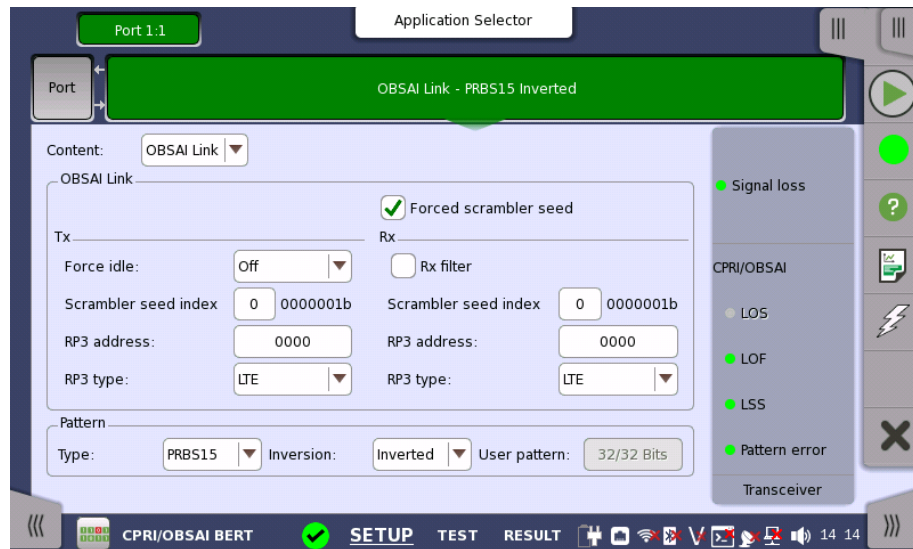

Forced scrambler seed

This check box is displayed when Line Rate is set to **6144.0 Mbps**.

When not selected: The seed value is displayed in **Scrambler seed index** of Rx upon completion of exchange of scrambler seeds. Until the scrambler seeds are exchanged, the most recently used seed value is used.

When selected: Scrambling and de-scrambling are processed by using the scrambler seed values set by the user for Rx and Tx, without exchanging the scrambler seeds.

Force idle

When Line Rate is set to other than **6144.0 Mbps**, idle patterns are sent if selecting **On**.

When Line Rate is set to **6144.0 Mbps** and the **Forced scrambler seed** check box is selected, you can select **IDLE_REQ** and **IDLE_ACK**

Scrambler seed index

These items appear when Line Rate is set to **6144.0 Mbps**.

Tx: Outgoing messages are scrambled based on this value.

Rx: Incoming messages are descrambled based on this value.

RP3 address

Tx: Specify the address of outgoing messages.

Rx: Specify the address of incoming messages.

RP3 type

Tx: Specify the data type of outgoing messages.

Rx: Specify the data type of incoming messages.

Rx filter

Select the check box to measure only messages whose Rx PR3 address and RP3 type match the filter settings. A No message alarm is detected when there are no matched messages during a measuring period.

8.1.3 Status Information

This section describes the status information available in the status area of the CPRI/OBSAI ports setup screen.

8.1.3.1 Status Summary

The status summary displayed for the CPRI/OBSAI interface consists of the following information:

Physical Status

The topmost part of the status area gives you access to information about the current physical status of the selected interface. A summary consisting of the most relevant status indicators is displayed constantly. By touching the summary, you can open the dialog box where you can view the detailed status information.

Alarm/Error Status

The middle part of the status area gives you access to alarm and error information for the selected interface. The current status is indicated by the lamp color.

A summary consisting of the most relevant alarm/error indications is displayed constantly. By touching the summary, you can open the dialog box where you can view all alarms/errors.

Monitor Status

At the bottom of the status area, a button that gives you access to the monitor information. By touching the button, you can launch the Transceiver information display.

8.1.3.2 Physical Details

Touching the topmost summary box in the status area of the **Ports Setup** screen launches the dialog shown below.

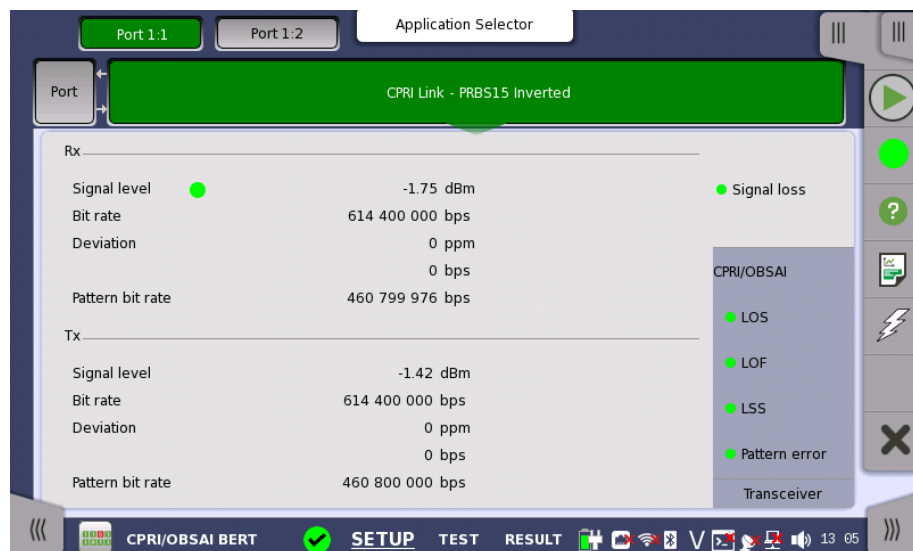

This screen presents information about the current state of the link.

Rx

- **Signal level:** shows the optical signal level in dBm. If the optical signal detection failed, a red indicator appears on the right.
- **Bit rate:** shows the actual bit rate of the receiver (in bps).
- **Deviation:** shows the deviation from the relevant nominal bit rate.

- **Pattern bit rate:** shows the bit rate of the pattern in received frames (in bps).

Tx

- **Signal level:** shows the output power of the optical transmitter.
- **Bit rate:** shows the actual bit rate of the transmitter (in bps)
- **Deviation:** shows the deviation from the relevant nominal bit rate.
- **Pattern bit rate:** shows bit rate of the pattern in transmitted frames (in bps).

8.1.3.3 Alarms and Errors

Touching the lower summary box in the status area of the **Ports Setup** screen displays the status shown below.

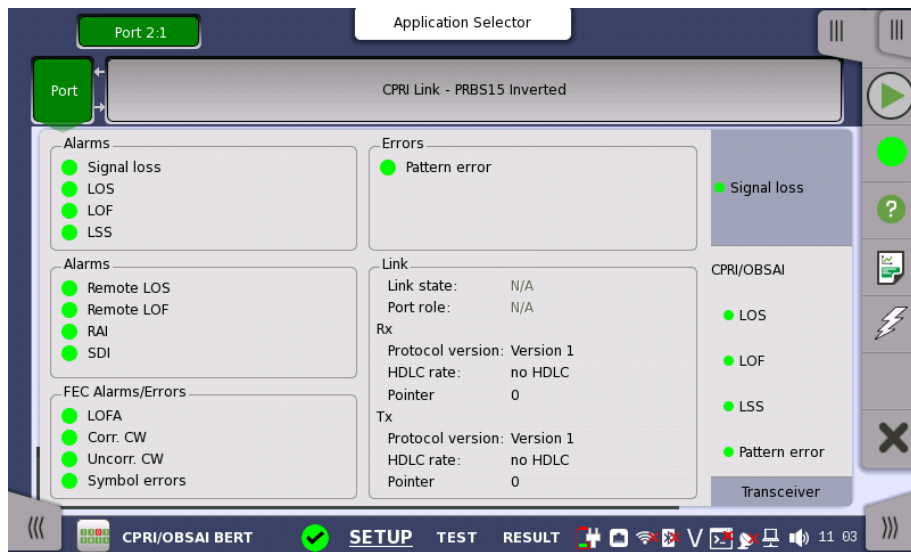

For CPRI Link

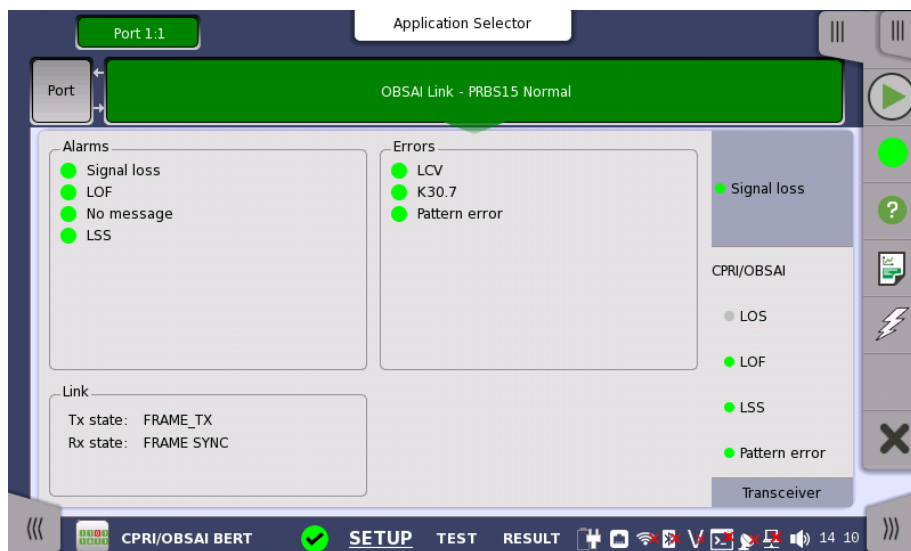

For OBSAI Link

This screen contains detailed alarm and error information related to the CPRI/OBSAI interface. Status is indicated by the use of [colored Lamp icons](#). **Remote** is displayed only when the content is set to CPRI Link. **Link** is displayed only when the content is set to CPRI Link or OBSAI Link.

Alarms

- **Signal loss:** This indicator turns red when the optical signal is not detected.
- **LOS:** Loss of Signal.
For 614.4 to 9830.4 Mbps, this indicator turns red when at least sixteen 8B/10B violations occur among a whole hyperframe.
For 10137.6 Mbps, this indicator turns red when at least four 64B/66B sync header code violations occur among a whole hyperframe.
- **LOF:** Loss of Frame.
CPRI Link
This indicator turns red when the hyperframe alignment cannot be achieved or is lost.
OBSAI Link
This indicator turns red when the master frame alignment cannot be achieved or is lost.
- **No message:**
This indicator turns red when no OBSAI messages are detected for one second.
- **LSS:** Loss of Signal Synchronization.
This indicator turns red when 10 % or larger bits in the test pattern have occurred errors.

Errors

- **LCV:** Line Code Violations (8B/10B decoding)
This indicator turns yellow when 10 bit sequence which is not defined in 8B/10B conversion table have been received.
- **SHV:** This indicator turns yellow when Invalid sync header (Sync bit is 00B or 11B) have been detected.
- **K30.7:** Invalid 10B code (8B/10B decoding)
This indicator turns yellow when 10 bit sequence which is defined as '10B error code' in 8B/10B conversion table have been received.
- **Pattern error :** Bit error of the pattern

FEC Alarms/Errors

These indicators appear if **FEC enable** is selected.

- **LOFA:** Loss of frame alignment
- **Corr. CW:** Corrected Codewords
- **Uncorr. CW:** Uncorrected Codewords
- **FEC symbol errors:** Symbol error(s)

Remote

Lights in red when the receiving bit in L1 Inband Protocol is "1". These bits are located in Z.130.0 in the hyperframe.

- **Remote LOS:** Loss of Signal detection
- **Remote LOF:** Loss of Frame detection
- **RAI:** Remote Alarm Indication
- **SDI:** SAP (Service access point) Defect Indication
- **Reset:** Master - Reset acknowledge, Slave - Reset request

Link

CPRI	OBSAI
<p>Shows the CPRI Link status.</p> <p>Link State and Port Role appear when Start up is set to Enabled.</p> <ul style="list-style-type: none"> Rx <ul style="list-style-type: none"> Protocol version HDLC rate Pointer Tx <ul style="list-style-type: none"> Protocol version HDLC rate Pointer 	<p>Displays status defined by OBSAI RP3.</p> <ul style="list-style-type: none"> Tx State <ul style="list-style-type: none"> TX_OFF IDLE^{*1} IDLE_REQ^{*2} IDLE_ACK^{*2} FRAME_TX Rx State <ul style="list-style-type: none"> UNSYNC WAIT_FOR_SEED^{*2} WAIT_FOR_ACK^{*2} WAIT_FOR_K28.7_IDLES WAIT_FOR_FRAME_SYNC FRAME_SYNC <p>*1: When Line Rate is set to other than 6144.0 Mbps</p> <p>*2: When Line Rate is set to 6144.0 Mbps</p>

8.1.3.4 Transceiver

Refer to [Transceiver](#) in "Ethernet Setup and Status".

8.1.4 Error/Alarm Insertion

This section describes how to configure settings for inserting errors or alarms by using the [Application toolbar](#) of CPRI/OBSAI.

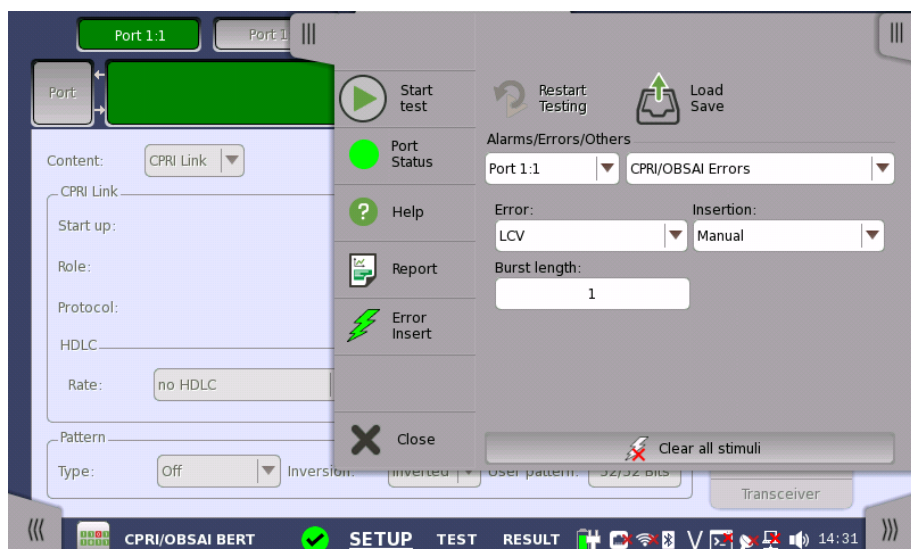

Alarms/Errors/Others

Select the port to insert errors, and the stimuli type. The settings items vary depending on the selected stimulus type.

8.1.4.1 CPRI/OBSAI Alarms

1. Select the CPRI/OBSAI Alarms.

2. Select the **Alarm** item.
3. Select the **Insertion**.
 - **Off**: Does not insert alarms.
 - **Permanently**: Inserts alarms permanently.

8.1.4.2 CPRI/OBSAI Errors

1. Select the **CPRI/OBSAI Errors**.
2. Select the **Error** item.
3. Select the **Insertion**.
 - **Off**: Turns off inserting errors.
 - **Manual**: Inserts the specified number of errors if you touch the Error Insert icon.
Touch the **Burst length** field to set the number of errors to insert.
 - **1E-04** to **1E-10**: Inserts errors at the specified rate continuously.
4. When selecting **Manual**, touch the Error Insert icon () to insert an error.

8.1.4.3 CPRI/OBSAI Frequency

1. Select the **CPRI/OBSAI Frequencies**.
2. Touch the **Frequency Offset** field to set an offset in ppm. If setting a positive value, the frequency will shift higher side.

8.2 CPRI/OBSAI BERT



This section describes the Bit Error Rate Test (BERT) that is applicable to CPRI/OBSAI interfaces.

For CPRI/OBSAI BERT of OTN interface, refer to [BERT](#) in "OTN Application".

8.2.1 Ports Setup and Status

After the application is launched, first configure the port interface in the **Ports Setup** screen where you can view port status information.

The setup options and status information related to the CPRI/OBSAI interfaces are described in a separate section:

- [CPRI/OBSAI Setup and Status](#)

For applications including an OTN interface, you can find a description of the setup options and status information for OTN in a separate section:

- [OTN Setup and Status](#)

Refer to the sections relevant to your current port setup requirements.

8.2.2 Test Setup

8.2.2.1 Control

When you proceed to the test setup of the CPRI/OBSAI BERT application, the following screen is displayed.

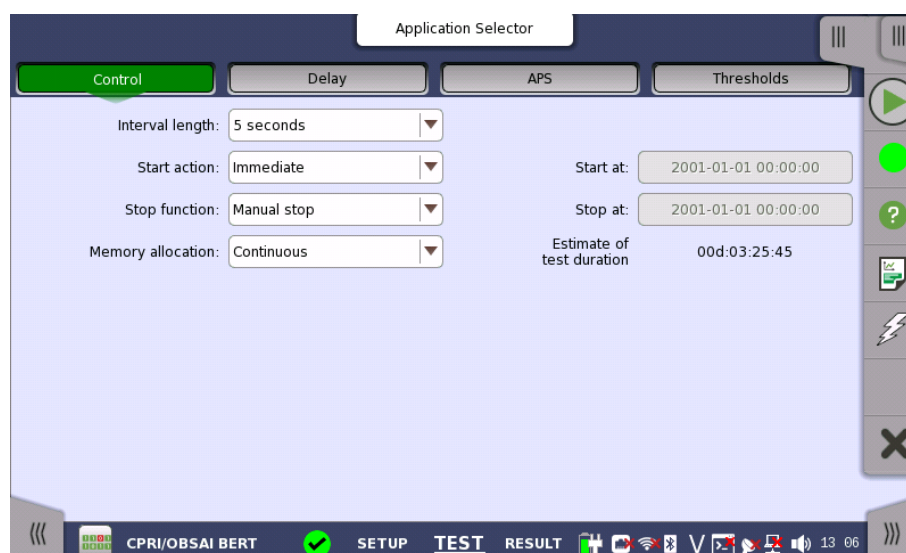

This screen contains the parameters that are generally required for BERT test.

Interval length

Allows you to specify the duration of the BERT intervals. The drop-down menu contains the following values: 1, 2, 5, 10, 15, 30 seconds, 1, 5, 10, 15, 30 min., 1, 2, 4, 6, 12 hours or No Intervals.

Start action

Allows you to specify when the measurement is started.

- **Immediate:** Starts the measurement when you touch the **Start** button.
- **Start at:** Starts the measurement at the time specified in the **Start at** field on the right.

Stop function

Allows you to specify when the measurement ends. Select the relevant option from the drop-down menu:

- **Manual stop:** Stops the measurement immediately when you touch the **Stop** button.
- **Stop at:** Stops the measurement at the time specified in the **Stop at** field on the right.
- **Duration:** Performs the measurement for the duration of time specified on the right.

Memory allocation

Allows you to specify how the measurement will be stored in the Network Master's memory. Select the relevant option from the drop-down menu:

- **Use all storage:** When Network Master's memory became full of measured data, the whole measurement is stopped.
- **Continuous:** When Network Master's memory became full of measured data, the oldest records in that memory will be overwritten. When the memory became full, it is recorded in [Event log](#).

The Network Master's memory size (the file size of measurement results) is 64 Mbytes per one port. The result file size is less than 64 Mbytes because it is compressed when saving to the file.

Estimate of test duration

Contains an estimation of the time (in days, hours, minutes and seconds) before the whole memory will be filled out by the test. During an ongoing measurement, the estimate will be recalculated periodically.

Performance Parameters

These items appear if **OTN Tx** and **OTN Rx** are selected on Setup screen.

OTN

G.8201, M.2401 (M.2110)

Time period

15 minutes, 1 hour, 2 hours, 24 hours, 7 days

Allocation

Touching the **Setup** button launches the dialog box. Refer to [Performance Parameters](#) in "OTN Application" .

8.2.2.2 Delay

Touching the **Delay** button in the navigation area displays the screen to set threshold value.

Delay

Select the check box to enable the judgement using the threshold value.



If selecting check box, Port setup is changed as following:
 Content: CPRI Link or OBSAI Link
 Error insertion item: LCV
 The check box will be cleared if Content has changed to other options.

Threshold

Allows you to specify a threshold value of Round Trip Delay in micro seconds (μs).

8.2.2.3 APS

Touching the **APS** button in the navigation area displays the screen to setup the APS test.

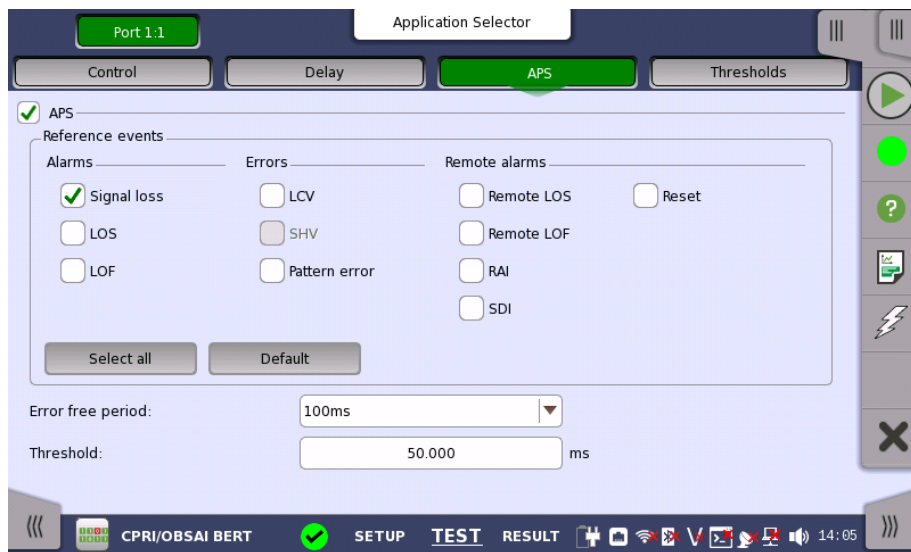

For CPRI Link

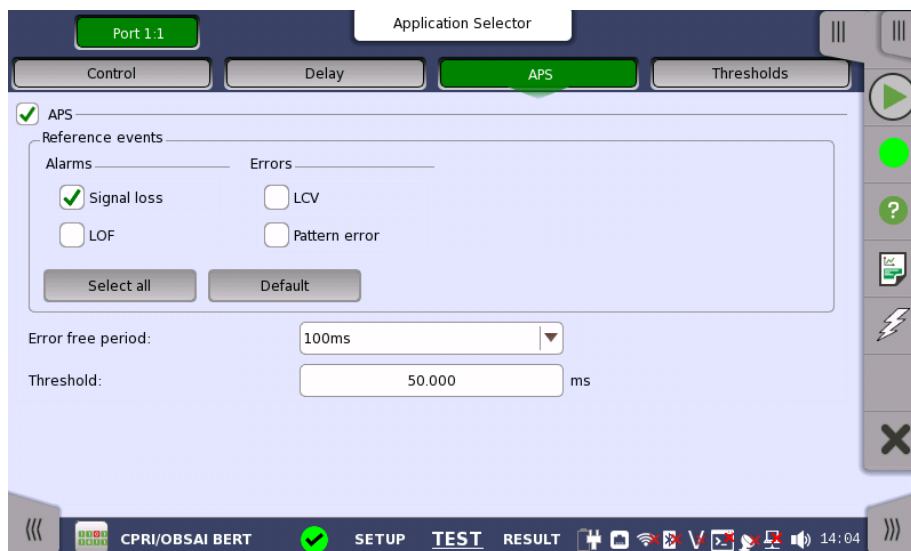

For OBSAI Link

APS

Select the check box for executing APS test during BER measurement.

Reference events

Select the check box of **Alarms**, **Errors** or **Remote alarms** for setting to reference event.

Error free period

If a reference event is not generated within the time of this cycle, end the switching time measurement.

Threshold

Allows you to specify a Pass/ Fail threshold value of switching time in milliseconds.

8.2.2.4 Thresholds

Touching the **Thresholds** button in the navigation area displays the following screen.

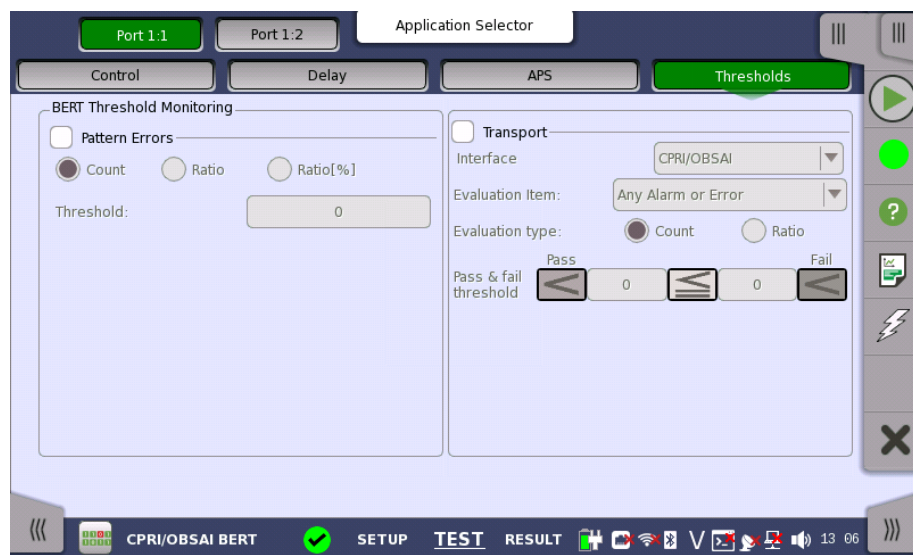

For details on settings, refer to [Thresholds](#) in BERT section of "SDH/SONET/PDH/DSn Applications".

8.2.3 Test Results

8.2.3.1 Summary

When you go to the test results of the CPRI/OBSAI BERT application, the following screen is displayed.

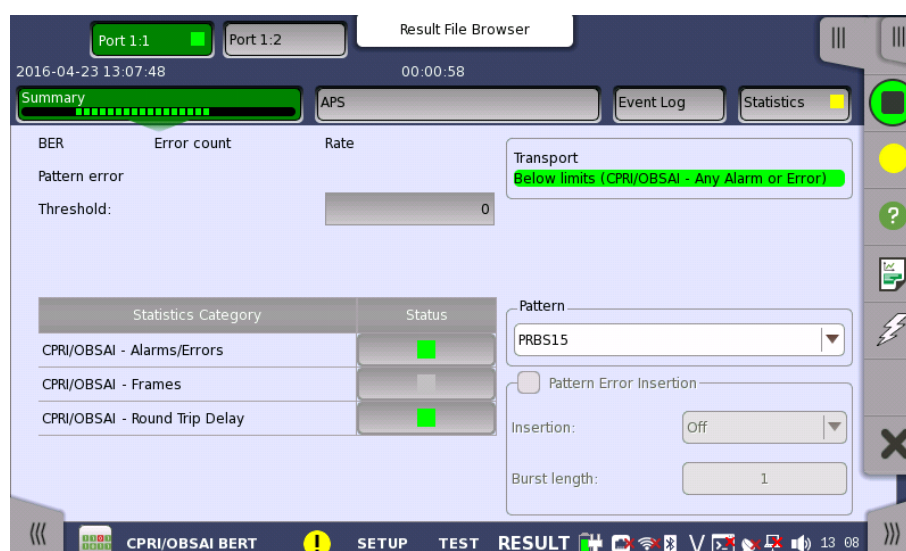

This screen contains a summary of CPRI/OBSAI BERT results.

Statistics Category

The lamp icon in Status column shows the Pass or Fail results for each category. Touching the Status column displays the statistics results.

Transport

Displays the results of Transport test. This result appears if 'Transport' check box is selected in the Test Setup screen.

Pattern

Select the pattern.

Pattern Error Insertion

Select the check box to enable the pattern error insertion.

Insertion

Select the timing of the error insertion from the drop-down menu.

- **Off**: Stops the error insertion.
- **Manual**
- **1E-04 to 1E-09**

Burst length

If 'Insertion' is set to **Manual**, touch the button and set the burst length to insert.

8.2.3.2 APS

If APS is selected on the Test screen, **APS** button appears in Navigation area. Touching the **APS** button will display the screen shown below.

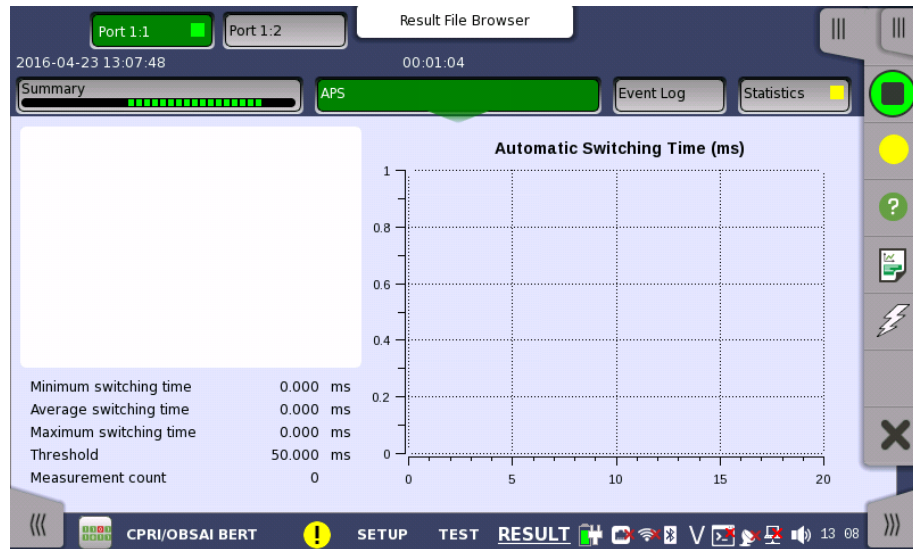

This screen shows the duration of all reference events, both in a list and in a graphic representation. This screen contains the summary field displayed below the list.

Summary field Consists of the minimum, maximum, and average automatic switching times in milliseconds, the specified Max. reference duration value, the number of measurements.

List-form information Presents the automatic switching times in list-form.

Graphical presentation The graphical presentation consists of a bar diagram of the automatic switching times. Results may be affected by unexpected alarms/errors.

8.2.3.3 Event Log

Touching the **Event Log** button in the navigation area displays the screen providing the event log data. Refer to [Event Log](#) of SDH/SONET/PDH/DSn BERT application.

8.2.3.4 Statistics

Touching the **Statistics** button in the navigation area displays the screen shown below.

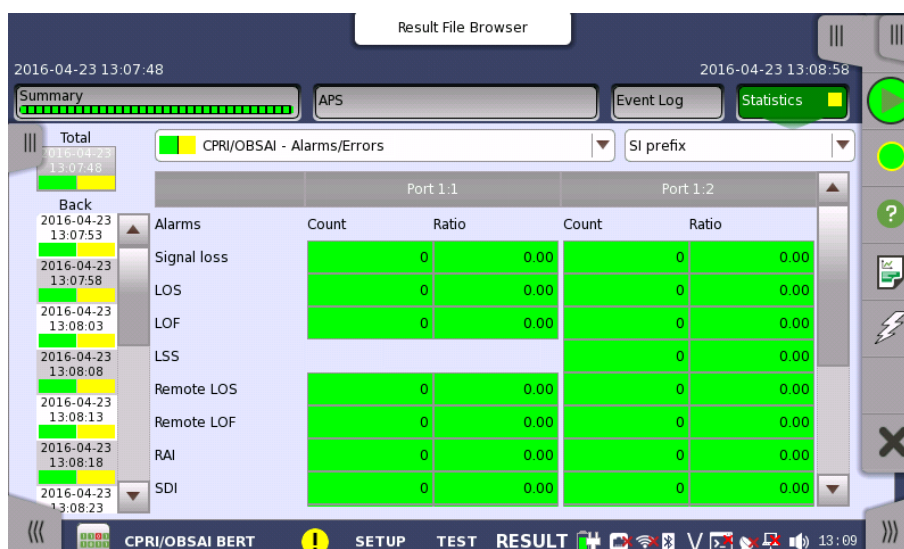

This screen presents a detailed analysis of the test results. You can choose to view either the results of a specific time interval or the total results from measurement start. The results can be displayed either in table (list) form or as graphs. You can also zoom in on a specific result item and display either a zoom or a histogram.

Selecting which results to view

Selecting the interval time

Touch the **Total** button to switch the total values measured in all interval times. The start time of measurement is displayed on the button.

Touching the button in left side **Back** field shows the measured values in the interval time. The end time of the interval is displayed on the button.

Current button is displayed at left bottom when the measurement is running. Touching the **Current** button shows the measured values in the current interval time. The start time of the current interval is displayed on the button.

The slide-out panel on the left-hand side of the screen contains the following functions:

- Only show intervals that contains errors
- Time format

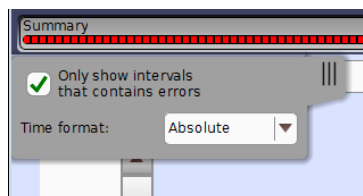

*If you have stopped measurement during the interval time, the measurement results of the current interval are discarded. The log of the current interval is not displayed in **Back** field.*

In this case, result data are re-calculated excluding the data of the current interval when the measurement is stopped. This causes that "Count" and "Ratio" displayed after the measurement will be different from that of during measurement. The sum of interval time (multiplied interval time by the number of back logs) may not match the differential time between displayed time at left top and right top after the measurement.

Selecting type of results

Open the left drop-down menu in the top row of buttons to select which results you want to display on the screen.

- OTN - Alarms/Errors
- OTN - Performance
- CPRI/OBSAI - Alarms/Errors
- CPRI/OBSAI - Frame
- CPRI/OBSAI - FEC
- Delay - Round Trip Time

OTN options appear if the CPRI signal is carried by OTN.

Round Trip Time appears if **Delay** check box is selected on Delay screen in Test Setup of BERT application.

Studying a specific result

Touch a specific cell in a result table to zoom in on the corresponding result item. The **Count** and **Ratio** fields are displayed on a **Zoom** tab page. A **Time vs. Statistics** tab page is also available. Use the **Back** button or touch the zoom filed to return to the statistics screen.

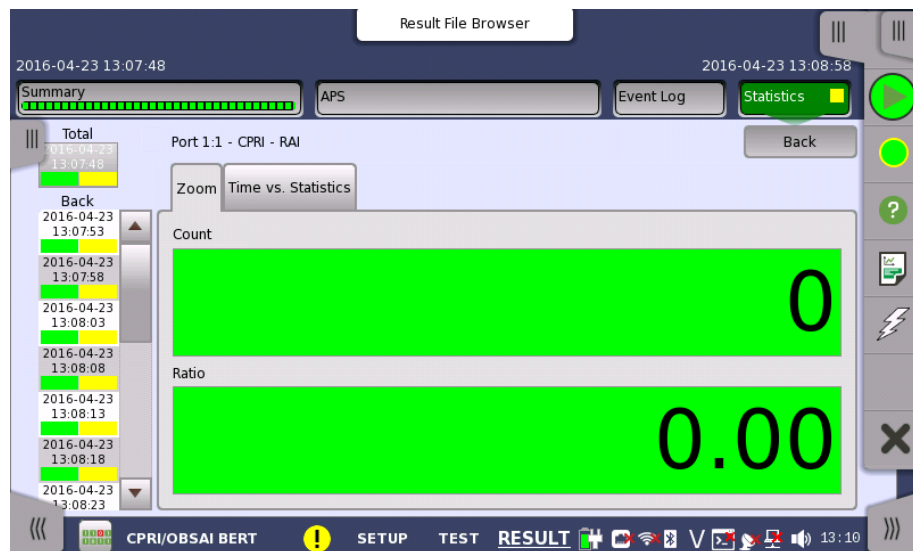

Selecting notation

Select the required notation for the results from the notation drop-down menu.

- **Unformatted** - e.g. 71892
- **SI prefix** - e.g. 71.891 k (k means "kilo")
- **Engineering** - e.g. 71.892E3
- **Scientific** - e.g. 7.1892E4

Results

Results are displayed according to your choice.

OTN Alarms/Errors	Refer to Results in "OTN Application"
OTN Performance	Refer to Results in "OTN Application"
CPRI/OBSAI - Alarms/Errors Results	Alarms Errors
CPRI/OBSAI - Frame Results	Frame count

(On **Rx code words** and **Tx code words**, the following results are displayed depending on Line rate setup.

CPRI option 1 to 7: number of 10b codes

CPRI option 8 to 10: number of 66b blocks)

CPRI/OBSAI - FEC Results

FEC Errors

CPRI/OBSAI - Round Trip Delay Results

Delay

Measurement count

8.3 CPRI P. Through



CPRI P. Through enables non-intrusive in-service monitoring. All traffic received on a port is forwarded on the other port and vice versa. Traffic between the two network DUT elements is monitored as illustrated below.

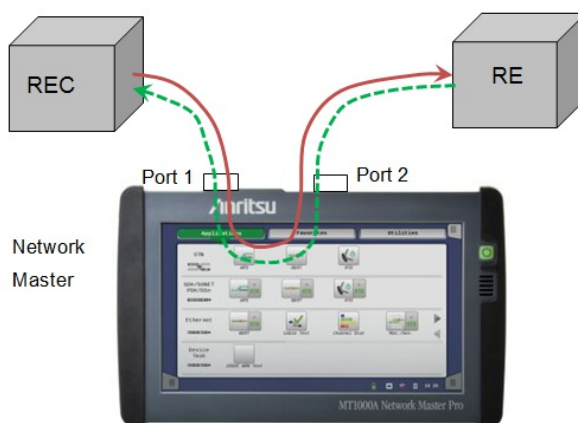

8.3.1 Ports Setup and Status

The first step in running an application is to set up the port interfaces. This is done on the **Ports Setup** screen, which also provides port status information.

The setup options and status information related to the CPRI interface are described in a separate section:

- [CPRI/OBSAI Setup and Status](#)



*For the CPRI P. Through application, CPRI option9 (12165.12 Mbps) and CPRI option10 (24330.24 Mbps) are not available for **Line rate**.*

8.3.2 Test Setup

8.3.2.1 Control

Refer to "[Control](#)" in the BERT section.

8.3.2.2 Thresholds

Refer to [Thresholds](#) of BERT section in "CPRI/OBSAI Applications".

8.3.3 Test Results

8.3.3.1 Summary

When you go to the test results of the CPRI P. Through application, the following screen is displayed.

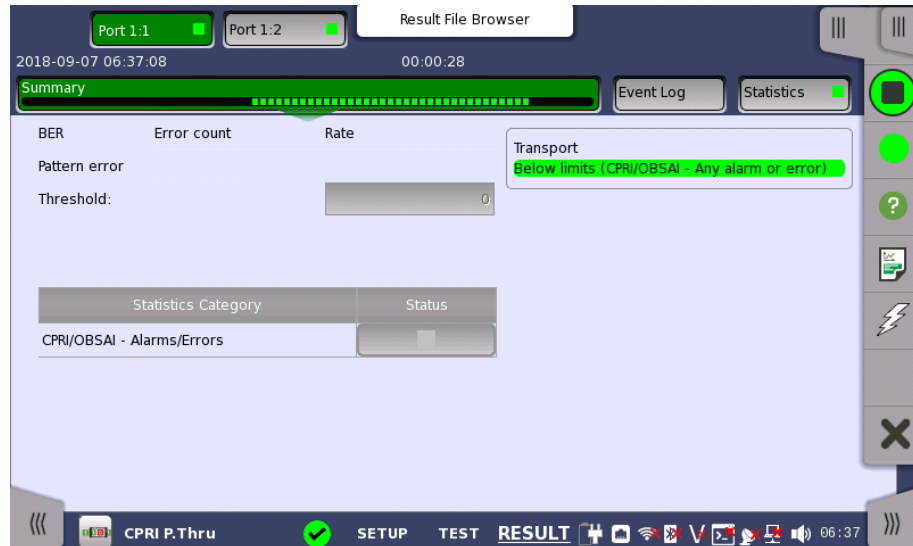

This screen contains a summary of the results of the CPRI P. Through test.

Transport

Displays the results of Transport test. This result appears if 'Transport' check box is selected in the Test Setup screen.

8.3.3.2 Event Log

Touching the **Event Log** button in the navigation area displays the screen providing the event log data. Refer to [Event Log](#) of SDH/SONET/PDH/DSn BERT application.

8.3.3.3 Statistics

Touching the **Statistics** button in the navigation area displays the screen providing the statistics data. Refer to [Statistics](#) of BERT for the operation.

Selecting type of results

Open the left drop-down menu in the top row of buttons to select which results you want to display on the screen.

- CPRI/OBSAI - Alarms/Errors
- CPRI/OBSAI - Frame
- CPRI/OBSAI - Pass through

8.4 eCPRI/RoE BERT



RoE (Radio over Ethernet) is the way to control radio base stations over Ethernet and means two standards below. RoE BERT measures the bit error rate of received signal according to these standards.

- eCPRI Specification V1.0 (Common Public Radio Interface)
- IEEE 1914.3 Standard for Radio over Ethernet Encapsulations and Mappings

eCPRI protocol stack is shown in the figure below.

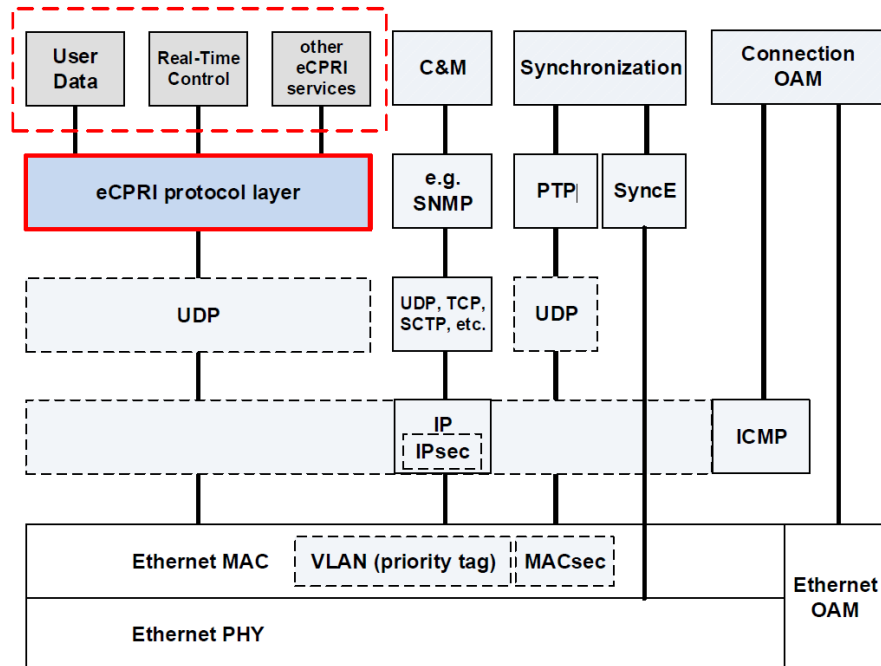

RoE encapsulation in Ethernet frames is shown in the figure below.

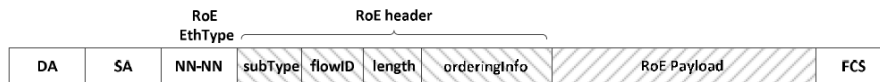

- DA: Destination MAC Address
- SA: Source MAC Address
- NN-NN: EtherType (0xFC3D)
- subType (sub type) field: 8 bits
- flowID (flow identifier) field: 8 bits
- length (length) field: 16 bits
- orderInfo (timeStamp/seqNum) field: 32 bits
- FCS: Frame Check Sequence

8.4.1 Enable 25 Gbps bit rate for two ports in eCPRI/RoE BERT application



25G eCPRI/RoE Dual Port Ability appears only when the MU100011A-075 Advanced 25G eCPRI/RoE is installed.

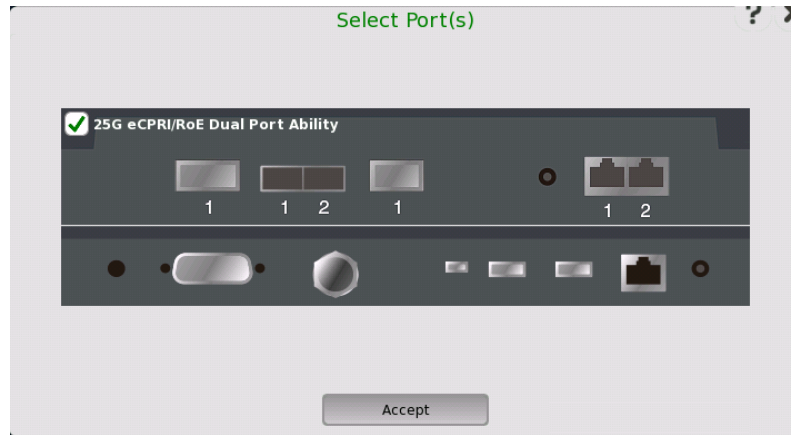

- When the check box is selected:
You can select the 25 Gbps bit rate in the eCPRI/RoE BERT application for both Port 1 and Port 2. However, only the eCPRI/RoE BERT application can be started for each port.
- When the check box is cleared:
If the MU100011A-017 Ethernet Single Channel is installed, the 25 Gbps bit rate can be set by selecting one port. If MU100011A-017 is not installed, the 10 Gbps or lower bit rate can be set. In case of selecting only one port, you can launch the Ethernet application or the eCPRI/RoE BERT application for the other port.

When the check box is selected

Port 1	Port 2	Not used	Ethernet	eCPRI/RoE BERT 10G max.	eCPRI/RoE BERT 25G
Not used	Not used			✓	✓
Ethernet	Not used			-	-
eCPRI/RoE BERT 10G max.	Not used	✓	-	✓	✓
eCPRI/RoE BERT 25G	Not used	✓	-	✓	✓

When the check box is cleared

Port 1	Port 2	Not used	Ethernet	eCPRI/RoE BERT 10G max.	eCPRI/RoE BERT 25G
Not used	Not used			✓	*
Ethernet	Not used			✓	*
eCPRI/RoE BERT 10G max.	Not used	✓	✓	✓	*
eCPRI/RoE BERT 25G	Not used	*	*	*	-

*: MU100011A-x17 is required.

8.4.2 Ports Setup and Status

8.4.2.1 Physical Port Setup

The first step in running an application is to set up the port interfaces. This is done on the **Ports Setup** screen, which also provides port status information.

The setup options and status information related to the Ethernet interface are described in the following section:

- [Ethernet Setup and Status](#)

The Ethernet setup screen for eCPRI/RoE BERT is different from the Ethernet application setup screen in the following points.

Button	Difference
WAN	Not displayed.
Stream	Unframed cannot be set. Radio Frame setting is added in Stream Setup dialog box.
Settings	Inband tab is not displayed.
Filter	Not displayed.

8.4.2.2 Port configuration parameters

This subsection describes port setup parameters when **25G eCPRI/RoE Dual Port Ability** is selected.

Port definition

You can use either a 'quick mode' or a 'detailed mode' to set up the port. Touching the long button at the top of the setup area will launch the Port Setup dialog box. Touching the right part of the button () will open the *quick setup menu*.

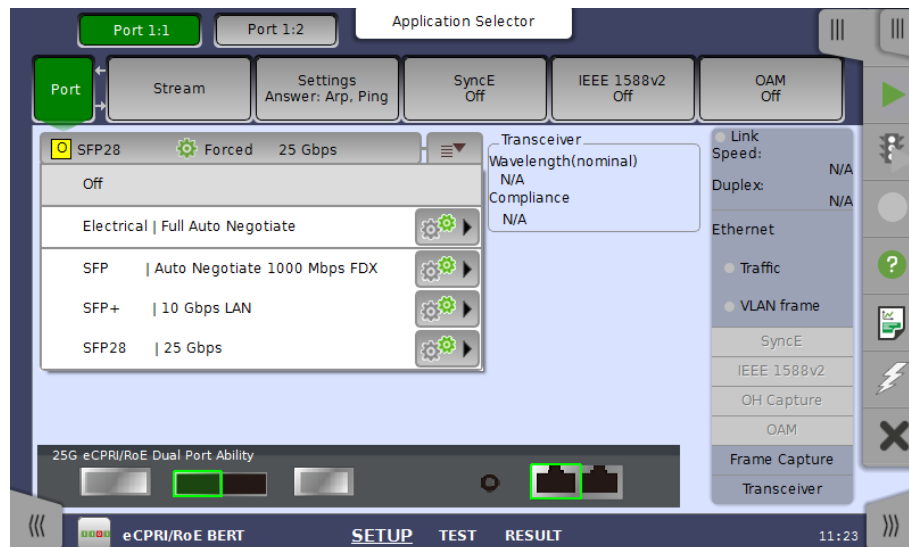

The quick setup menu contains a number of predefined port configurations (e.g. **Electrical | Forced 100 Mbps FDX**). The detailed mode dialog allows you to specify the configuration yourself.

Touching  displays the **Dual Port Interface Constraint Setup** dialog box.

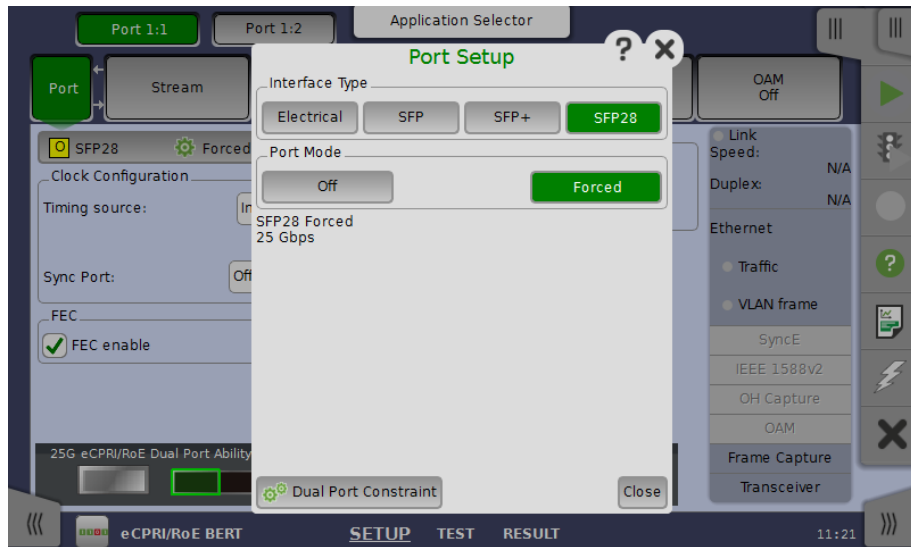

Touching **Dual Port Constraint** displays the **Dual Port Interface Constraint Setup** dialog box.



To change the interface type from **SFP28** to other than **SFP28** or other than **SFP28** to **SFP28**, be sure to select the bit rate corresponding to the interface type you want to change in the [Dual Port Interface Constraint Setup](#) dialog box.

Clock Configuration

Timing source

Select a source to synchronize all Ethernet transmitters to.

The possible sources are:

- Internal
- External
- GPS
- Received
- IEEE 1588v2

Received appears when the interface type is set to **SFP**, **SFP+**, or **SFP28**

IEEE 1588v2 appears when the interface type is set to **Electrical SFP**, or **SFP+**.

Sync Port

This item appears when using MU100011A and Interface Type is set to **SFP28**.

Selects the output of Sync Clock Output connector on MU100011A panel.

- **Off**: does not output the clock.
- **1/8**: outputs 1/8 divided clock of the data synchronized clock (approximately 3.222 GHz).
- **1/16**: outputs 1/16 divided clock of the data synchronized clock (approximately 1.611 GHz).

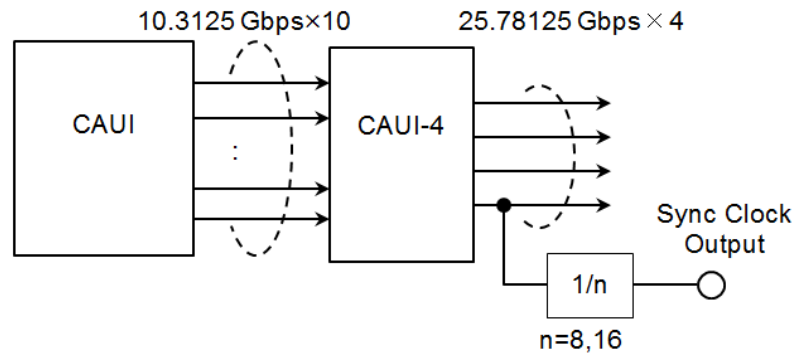

Block Diagram of MU100011A Tx Part (QSFP28, CFP4)

FEC**FEC enable**

This setting appears when using MU100011A and Interface Type is set to SFP28.

- **On:** The calculated forward error correction data will be added to the 25G Ethernet frame and the 100G Ethernet frame.
- **Off:** FEC is not added to the 25G Ethernet frame and the 100G Ethernet frame.

Transceiver

Displays the Transceiver information.

8.4.2.1 Dual Port Interface Constraint Setup

Touching **Dual Port Constraint** in the Port Setup dialog box displays the Dual Port Interface Constraint Setup dialog box.

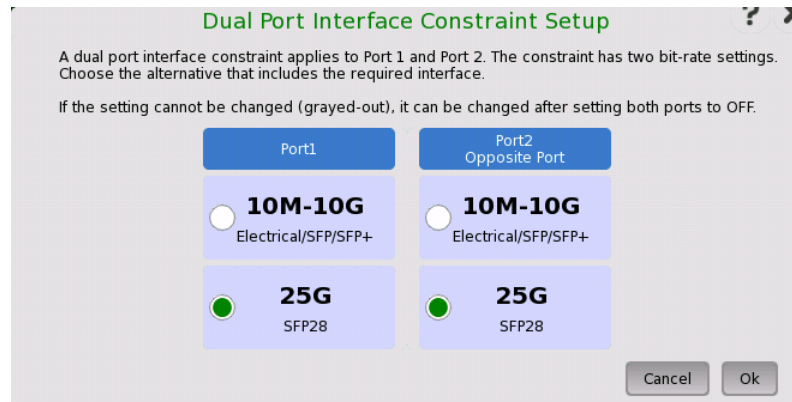

The Dual Port Interface Constraint Setup dialog box allows users to select a bit rate which can be used in the eCPRI/RoE BERT application.

Opposite Port is a different port from the port for which you are configuring the interface.

When you open the dialog box from the port 1 setting screen, the opposite port is port 2.

When you open the dialog box from the port 2 setting screen, the opposite port is port 1.

When the port mode of the opposite port is not **Off**, you cannot set the bit rate for the opposite port.

- **10M-10G:** Allows you to set the bit rate within the range of 10 Mbit/s to 10 Gbit/s in the eCPRI/RoE BERT application. Available interfaces are shown below.

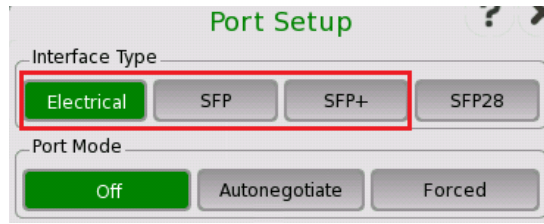

- **25G:** Allows you to set the bit rate at 25 Gbit/s in the eCPRI/RoE BERT application. Only **SFP28** can be set for the interface type. No other interfaces can be set.



If you touch  in the quick setup menu on the Port screen, the interface type is set simultaneously, and the bit rate cannot be changed in the dialog box. The check boxes are displayed in gray.



The bit rate set in the Dual Port Interface Constraint Setup dialog box overrides the interface type setting.

8.4.2.2 Streams

You can use either a 'quick' mode or a 'detailed' mode to set up the selection of headers/layers. Touching the button at the top of the setup area will launch the *detailed mode* dialog box (the [Stream Setup dialog box](#)). Touching the arrow to the right of the button will open the *quick selection menu*.

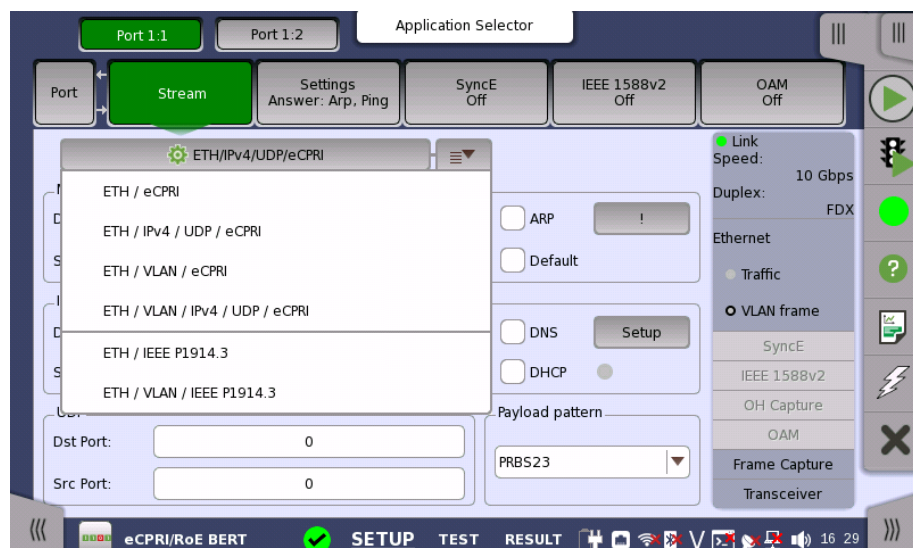

Layer configuration parameters

The settings related to each layer are described in detail below. The following layer buttons are available:

- [VLAN](#) (Level count is up to 2.)
- [IPv4](#) (for eCPRI)

- [IPv6](#) (for eCPRI)
- [UDP](#) (for eCPRI)
- [eCPRI](#)
- [IEEE 1914.3](#)
- [Variable](#)

In the eCPRI/RoE BERT application, the SNAP, LLC1, PBB, MPLS-TP, MPLS, Custom, and ETH buttons are not displayed.

eCPRI

Selecting the **eCPRI** in Radio Frame drop-down list displays the parameters available for the *eCPRI* protocol layer.

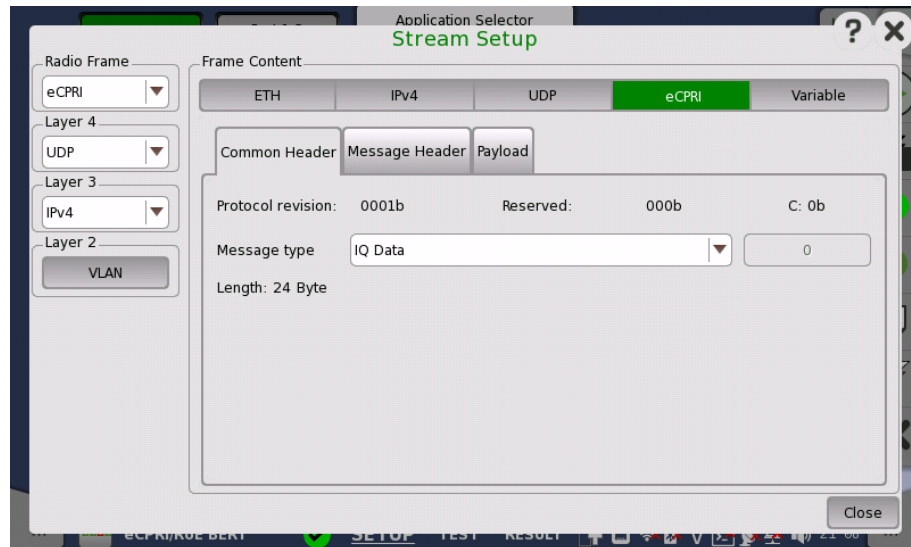

Common Header

Protocol version

The protocol version of eCPRI is displayed.

Reserved

"000b" is displayed.

C

- 0b: indicates that the eCPRI message is the last one inside the eCPRI PDU (protocol data unit).
- 1b: indicates that another eCPRI message follows this one within the eCPRI PDU.

Message type

Select a message type. When **User Defined** is selected, touch the right-hand field and enter the value.

Length

A byte length of Message Header and Payload are displayed.

Message Header

The items to be displayed vary according to the Message type.

IQ Data, Bit Sequence, Generic Data Transfer :	
PC ID	An identifier of a series of IQ Data messages, Bit Sequence messages, or Generic Data Transfer messages.
SEC ID	An identifier of each message in a series of messages.
Real-Time Control Data :	
RTC ID	An identifier of a series of Real-Time Control Data messages.
SEC ID	An identifier of each message in a series of messages.
Remote Memory Access :	
Remote Memory Access ID	The Remote Memory Access ID is used by the sender of the request when the response is received to distinguish between different accesses.
Read/Write	0: Read 1: Write 2: Write_No_Resp Other: Reserved
Req/Recp	0: Request 1: Response 2: Failure Other: Reserved
Element ID	Element ID is used for instance to point out a specific instance of a generic hardware function.
Address	Enter a memory address to read or write.
Length	2-byte Length field contains the actual number of bytes that were either written or read.
One-way Delay Measurement :	
Measurement ID	The Measurement ID is a 1-byte value used by the sender of the request when the response is received to distinguish between different measurements.
Action Type	Select an Action Type of the message.
TimeStamp	A time stamp data which information is specified by Action Type.
Compensation Value	When Action Type is set to 0x00 (Request), 0x02 (Response) or 0x05 (Follow_Up) in the message, this field will contain the 'Compensation Value' which is the compensation time measured in nanoseconds and multiplied by 2^{16} and follows the format for the correctionField in the common message header specified in IEEE 1588-2008 Clause 13.3 [13].
Remote Reset :	
Reset ID	An identifier of a Remote Reset message.
Reset Code Op	1: Remote reset request 2: Remote reset response Other: Reserved

Event Indication :	
Event ID	A 1-byte value set by the transmitter of an Event Indication or a Synchronization Request to enable identification of the acknowledge response.
Event Type	Select a Event type.
Sequence Number	The Sequence Number is a 1-byte value that is incremented each time the transmitter sends the “Event Indication” with Event Type set to 0x00 (Fault(s) Indication).
Number of Faults/Notif	Number of fault indications or notifications attached in the same message.
Element ID	0 to FFFE: Vendor specific usage FFFF: A fault or notification applicable for all Elements
Raise/Cease	0: Raise a fault 1: Cease a fault
Fault/Notif	A 12-bit number indicating a fault or notification divided between 2 bytes.
Additional Information	Additional information regarding the fault/notification for vendor specific usage.

When **Event Indication** or **User Defined** is selected, the following is displayed.

Enable

Selecting the checkbox enables to edit Message Header which locates between Common Header and payload. When the checkbox is not selected, no Message Header is added.

Length

Enter a byte length of Message Header.

Custom pattern

Touch the field to edit the pattern.

- **Import:** loads a pattern from a file.
- **Export:** saves the pattern to a file.

Payload

Payload type

Select the payload type.

IEEE 1914.3

Selecting the **IEEE 1914.3** in Radio Frame drop-down list displays the parameters available for the *IEEE 1914.3* protocol layer.

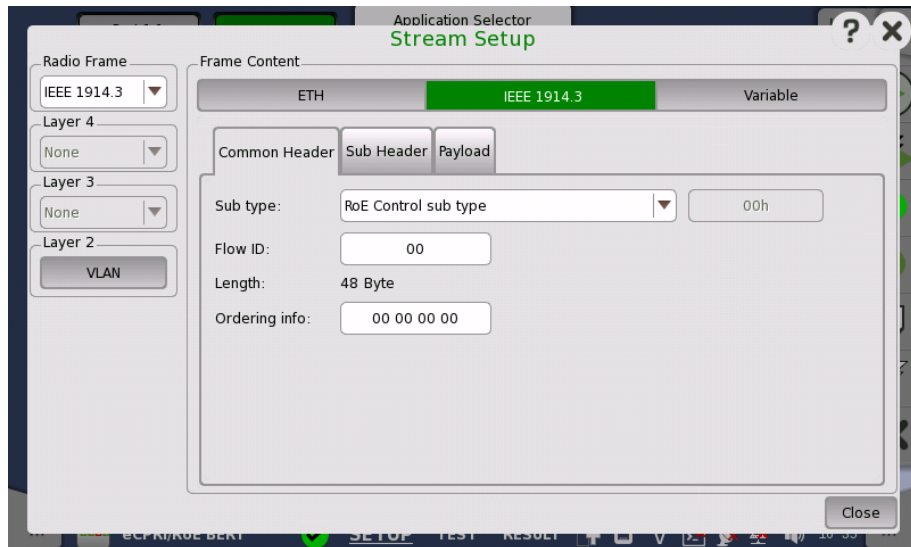

Common Header

Sub type

The 8-bit subType field is used to define the RoE sub type and the type of flow carried by the RoE packets. Select a Sub type. When **User Defined** is selected, enter the RoE sub type code in the right-hand field.

Flow ID

The flowID identifies a specific flow between two end-points. Touch the field to enter a flow id number.

Length

The value of the length is the total number of octets following the common RoE header. The length does not include the Ethernet FCS bytes.

Ordering info

Ordering information is assigned to each flow and is presented in one of two methods, a sequence number or time stamp. Touch the field to enter an Ordering information length.

Sub Header

Enable

Selecting the checkbox enables to edit Sub Header which locates between Common Header and payload. When the checkbox is not selected, no Sub Header is added.

Length

Enter a byte length of Sub Header.

Custom pattern

Touch the field to edit the pattern.

- **Import:** loads a pattern from a file.
- **Export:** saves the pattern to a file.

opCode

This item appears if Sub type is set to **Control sub type**. When other than **Control sub type** is selected, touch the field right-hand to enter a number.

Payload

Payload pattern

Select a PRBS type.

8.4.3 Test Setup

8.4.3.1 Control

Refer to "[Control](#)" in Ethernet BERT Test Setup subsection for the operation.

BERT Options

Selecting the check box enables to set items in the frame.

8.4.3.2 Generator

Refer to "[Generator](#)" in Ethernet BERT Test Setup subsection for the operation.

8.4.3.3 Stream - Profile

Refer to "[Stream - Profile](#)" in Ethernet BERT Test Setup subsection for the operation.

Following points are changed in eCPRI/RoE BERT application:

- Stream profile is fixed to **Data**.
- Encoding and Number of channels are not displayed.
- Frame size is fixed to **Constant**.

8.4.3.4 Stream - Meas.

Refer to "[Stream - Meas.](#)" in Ethernet BERT Test Setup subsection for the operation.

8.4.3.5 Thresholds

Refer to "[Thresholds](#)" in Ethernet BERT Test Setup subsection for the operation.

8.4.4 Test Results

8.4.4.1 Summary

When you go to the test results of the eCPRI/RoE BERT application, the following screen is displayed.

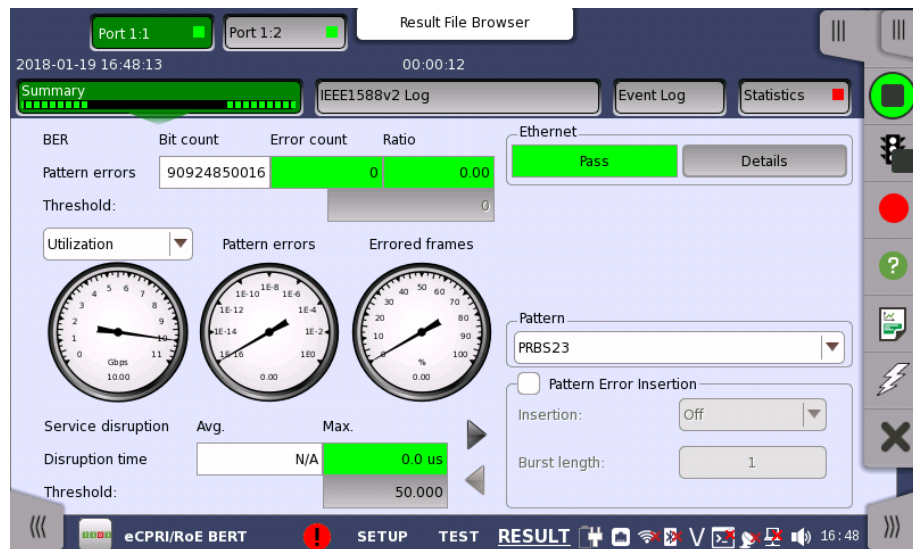

This screen contains a summary of the results of the eCPRI/RoE BERT test. The information includes such things as number of pattern errors, average and maximum disruption time, and number of exceeded thresholds.

The three dials showing utilization/throughput results, pattern errors and errored frames can be enlarged by touching on them. The black needle points the measured value in the latest period.

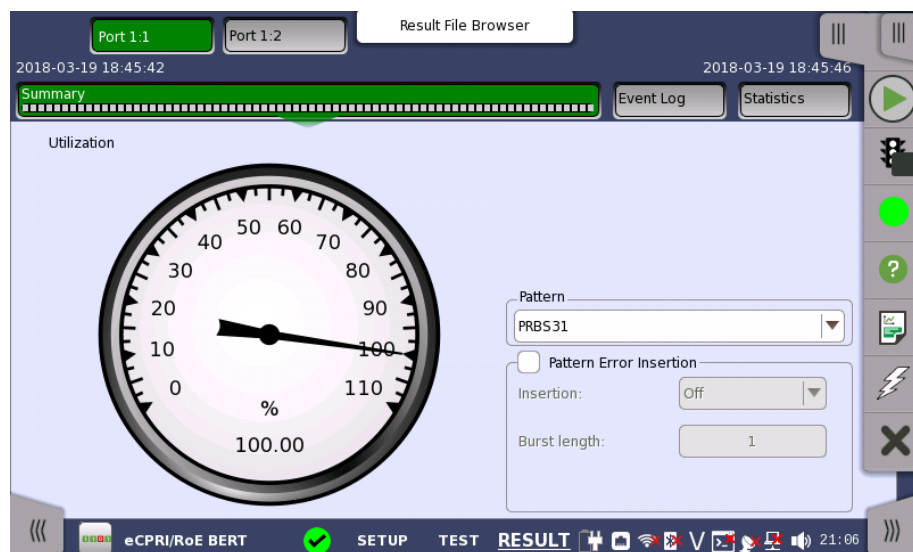

To view throughput information, select **Throughput** in the drop-down menu and then expand the dial. Use the drop-down menu above the expanded dial to select the relevant layer.

When **Ethernet** is selected on the 'Threshold' of Test Setup screen, the **Ethernet** information appears in the upper right-hand corner, shows pass/fail status summary. Touching the **Details** button allows you to inspect the individual pass/fail status.

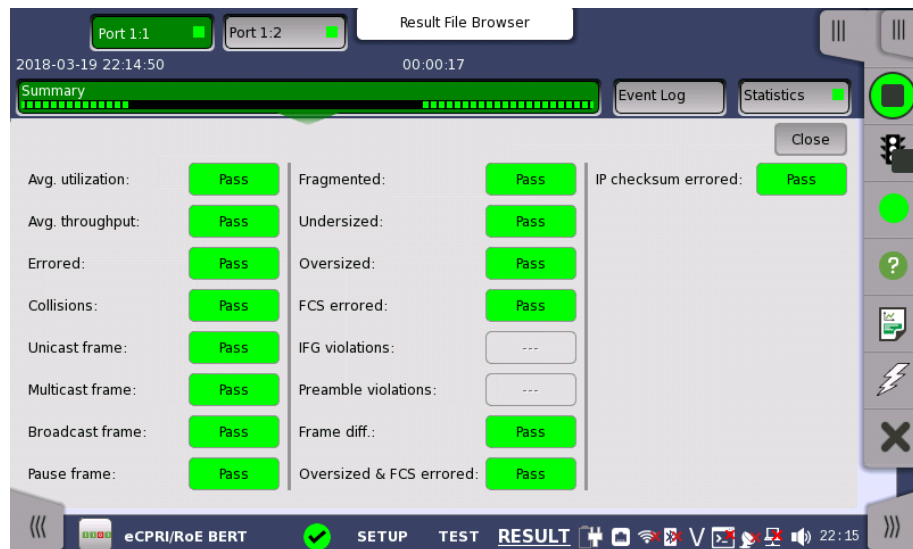

Pattern Allows to change the [payload pattern](#). **Cross pattern** check box is the same as **Cross pattern** at successive frames of Payload pattern setting.

Pattern Error Insertion This provides the same Error insertion as *Stimuli setup options* in [Application Toolbar](#).

Insertion

If selecting **Manual**, error(s) are inserted when you touch the **Alarm/Error Insert** icon (.

Set **Off** to stop the error insertion.

Burst length

If 'Insertion' is set to **Manual**, touch the button and set the number of errors to insert.

8.4.4.2 Event Log

Touching the **Event Log** button in the navigation area displays the screen providing the event log data. Refer to [Event Log](#) of SDH/SONET/PDH/DSn BERT application.

8.4.4.3 Statistics

Touching the **Statistics** button in the navigation area displays the screen providing the statistics data. Refer to [Statistics](#) of BERT for the operation.

9 Fibre Channel (FC) Applications

This chapter describes the graphical user interface (i.e. screens, sub-screens and major dialogs) related to Fibre Channel applications. Sub-screens and dialog boxes are described under the main screen from which they are activated/launched.

The following applications are available:

- [BERT](#)
- [Performance](#)
- [Reflector](#)

9.1 Fibre Channel Setup and Status

Fibre Channel (FC) is a high-speed network technology, commonly running at 1, 2, 4, 8, 16 and 20 Gigabit per second rates. It is primarily used to connect computer data storage.

The Fibre Channel Protocol (FCP) is a transport protocol similar to TCP used in IP networks. FCP predominantly transports SCSI commands over Fibre Channel networks.

Fibre Channel has five levels (FC-0 to FC-4), where FC-4 is the uppermost level and FC-0 the lowermost.

FC Level	Name	Description
FC-4	Protocol Mapping	Network and channel protocols such as SCSI-3.
FC-3	Common Services	Encryption, RAID redundancy algorithms etc.
FC-2	Data Delivery	Framing, flow control protocols and classes of service. Core layer of Fibre Channel.
FC-1	Data Encoding/Decoding	8b/10b encoding. (FC100 to FC800) 64b/66b encoding. (FC1200, FC1600)
FC-0	Physical layer	Fiber optics or copper cabling.



The Fibre Channel interface uses the optical ports.



MU100010A Connector Panel



MU100011A Connector Panel

9.1.1 Physical Port Setup

When the port is set up with a Fibre Channel interface, touching the **Port** button in the navigation area will display the screen shown below.

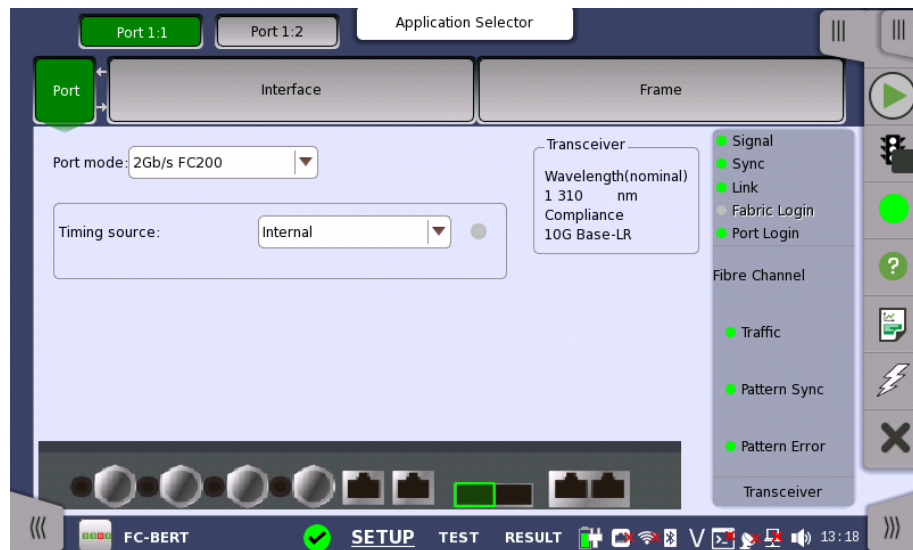

This screen allows you to specify the physical port configuration of the currently selected [Fibre Channel](#) port. It can also be used to inspect the current status of the selected port.

The configuration options available in the setup area of the screen are described below. The status information is described in a separate section.

Port mode

Select one from the following port mode options:

- **Off:** The transmission will be disabled.
- **1Gb/s FC100:** 100 MBytes/s
- **2Gb/s FC200:** 200 MBytes/s
- **4Gb/s FC400:** 400 MBytes/s
- **8Gb/s FC800:** 800 MBytes/s
- **10Gb/s FC1200:** 1200 MBytes/s
- **16Gb/s FC1600:** 1600 MBytes/s



*For Performance Test application, **16Gb/s FC1600** is displayed when one of Port 1 or Port 2 is selected at starting the application.*

Clock Configuration

Use the drop-down menu to select the clock source.

Timing Source

Internal: Internal clock of the module

External: The clock input to the connector

GPS: The clock provided from the external GPS sensor

Received: The clock generated from the received signal

When **External**, **GPS** or **Received** is set, the right hand lamp indicates whether a clock signal is detected or not.

Transceiver

Displays the Transceiver information.

9.1.2 Fibre Channel Frame Setup

9.1.2.1 Interface

Touching the **Interface** button in the navigation area displays the following screen.

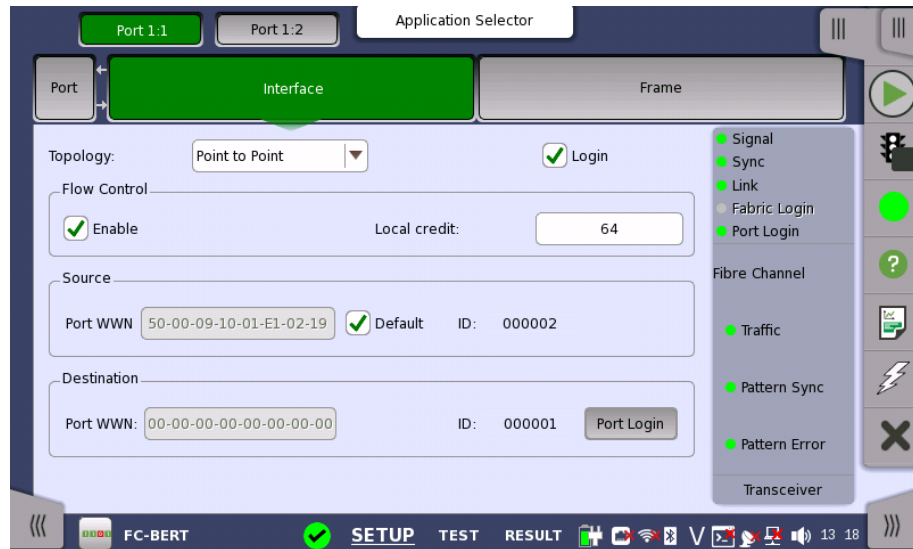

Topology

Point to Point is the direct connection to the device under test. Select the **Login** check box to establish the connection. For FC Reflector, selecting the **Login** check box requires peer to do an actual login.



Fabric is the connection using fibre channel switch. Touch **Fabric Login** button to access to the fabric login server.

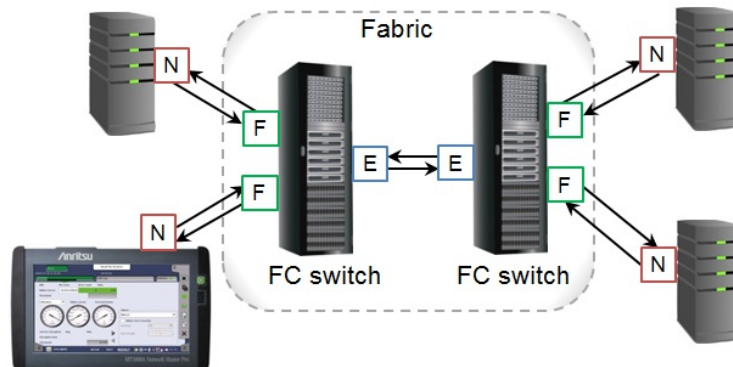

- **N**-Port: A hardware entity that includes a Link Control Facility, and has the ability to act as an Originator, a Responder, or both.
- **F**-Port: The Link Control Facility within the Fabric that attaches to an N_Port through a link.
- **E**-Port: A Fabric expansion port that connects to another E_Port to create an

Inter-Switch Link.

E-Port is selected when testing an connection port between the fibre channel switches. Touching **ELP** button exchanges Exchange Link Parameters with an E-port.

ELP: Exchange Link Parameters

Flow Control

Select the **Enable** check box to allow the flow control when 'Topology' is set to **Point to Point**.

If you are not logged in, touch **Remote credit** field to set the buffer size of the flow control.

The field name changes to **Local credit** when you login.

- **Local credit:** Network Master side BB Credit Count
- **Remote credit:** BB Credit Count of DUT (the opponent that Network Master communicate with)



Even if a sufficient number of credits are set, the phenomena that transmitting rate does not reach 100% may occur when the traffic is being received.

Source

When selecting the **Default** check box, Port WWN (World Wide Number) will be set automatically. When 'Topology' is set to **Point to Point**, set the Source Identifier in the frame header by touching the **ID** field.



Source settings are not used in the FC Reflector application.

Destination

Set the destination **Port WWN**. When 'Topology' is set to **Point to Point**, set the Destination Identifier in the frame header by touching the **ID** field.

Touch the **Port Login** button to establish the connection with the destination.



Destination setting is not used in FC Reflector.

Frame Setup

Set the **Framing** type of frames to reflect. Using **Point to Point** with login or **Fabric** requires a header in the frames.

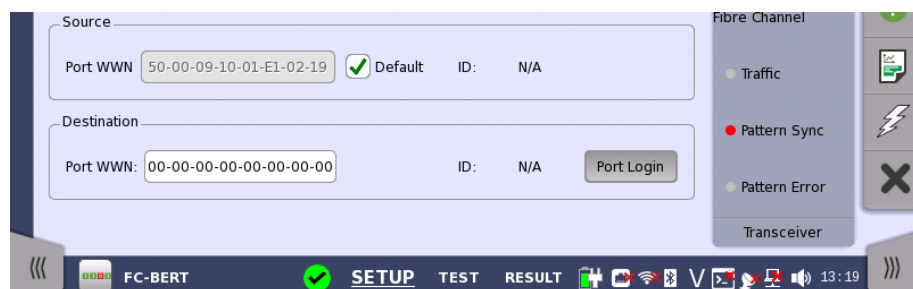

*Frame Setup setting is not used in FC BERT. In Fibre Channel Reflector mode you should activate connection to a FC Switch, after you have selected framing as **SOF:Header:Data:CRC:EOF**. If activating connection to a FC Switch when framing is set to **SOF:Data:EOF**, all frames outputted from the FC Switch are reflected to it. This phenomenon may cause malfunction of the FC Switches on the connected port.*

9.1.2.2 Frame

Touching the **Frame** button in the navigation area displays the following screen. **Frame** button appears in BERT and Performance applications.

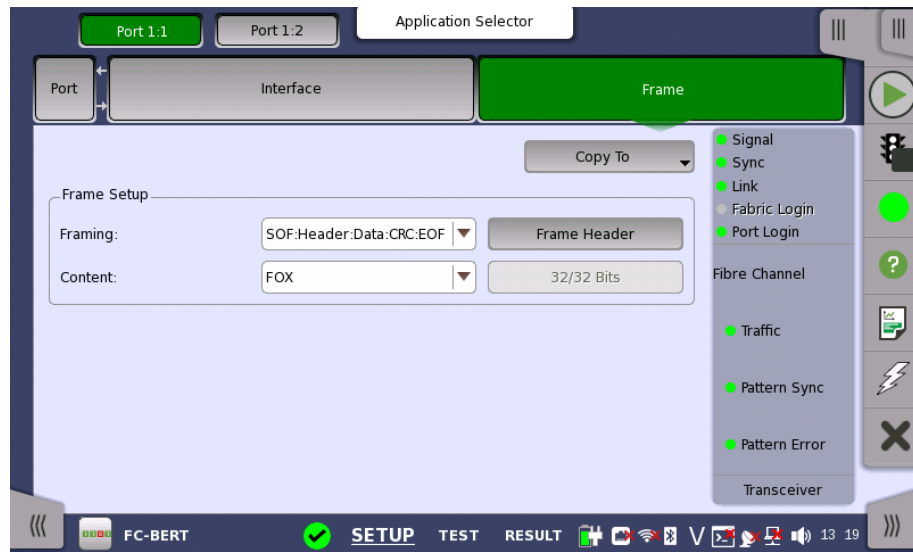

Copy frame content to other ports

This feature allows you to copy the frame content that you are currently configuring to frame content in another port.

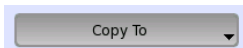

Touching the **Copy To** button opens a drop-down menu from which you can select the relevant port.



Follow another port

It is possible to let the Port 2 copy the setup from Port 1 by touching the **Follow** button. When this button is displayed in green, Port 2 continues to follow Port 1 change. This button appears when the Port 1 settings can be copy to Port 2.

Frame Setup

Framing

Select the frame structure in the drop-down menu.

- **SOF:Data:EOF**: Start of Frame - Data - End of Frame

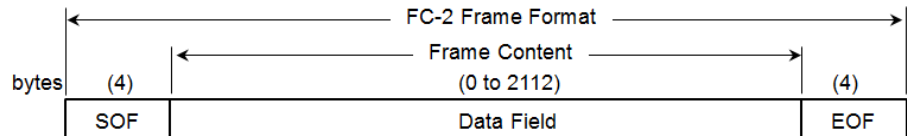

- **SOF:Header:Data:CRC:EOF**: Start of Frame - Frame Header - Data - CRC - End of Frame

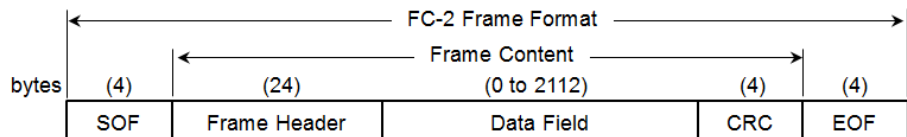

Content

Select a predefined pattern or define a user pattern.

- **FOX**: ASCII code bit sequence of "The quick brown fox jumped over the lazy dog 1234567890".

- **5555**: Repetition of "0101010101010101".
- **PRBS9** to **PRBS31**: Pseudo-random bit sequence. For PRBS9, its bit length is 511 ($=2^9-1$).
- **HF TEST**: High frequency test pattern. (Defined in IEEE802.3 Annex 48A)
- **CRPAT**: Compliant random data pattern.
- **JTPAT**: Jitter tolerance test pattern.
- **SPAT**: Supply noise pattern.
- **User 32 bit**: Repetition of the user defined 32 bits.
- **ZERO**: All bits are "0".

If you select the **User 32 bit** pattern, you can edit the bit pattern by touching the right-hand field.

Frame Header

Touching the **Frame Header** field launches the dialog box shown below.

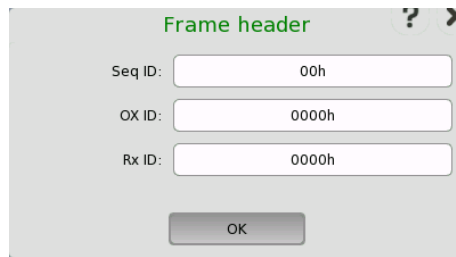

This dialog box allows you to configure the frame header for framed Fibre Channel signals. The following parameters can be edited:

- **Seq ID**: Unique frame sequence identifier
- **OX ID**: Originator Exchange ID
- **Rx ID**: Responder Exchange ID

The figure below shows the full frame header structure in four bytes by six rows. The parts which can be edited are shown as colored boxes.

R_CTL	Destination ID (D_ID)	
CS_CTL	Source ID (S_ID)	
TYPE	Frame control (F_CTL)	
SEQ_ID	DF_CTL	SEQ_CNT
OX_ID		RX_ID
Parameter field (PARM)		

9.1.3 Status Information

This section describes the status information available in the status area of the Fibre Channel ports setup screen.

9.1.3.1 Status Summary

The status summary displayed for the Fibre Channel interface consists of the following information:

Physical Status

The topmost part of the status area gives you access to information about the current physical status of the selected interface. A summary consisting of the most relevant status indicators is displayed constantly. By touching anywhere in this part, you can open a dialog box that contains the detailed status information.

Alarm/Error Status

The middle part of the status area gives you access to alarm and error information for the selected interface. The status is indicated by the Lamp color. You can choose whether to view only the current alarm and error status, or to view all alarms and errors in the alarm trap since it was last reset.

A summary consisting of the most relevant alarm/error indications is displayed constantly.

9.1.3.2 Physical Details

Touching the topmost summary box in the status area of the **Ports Setup** screen opens the dialog shown below.

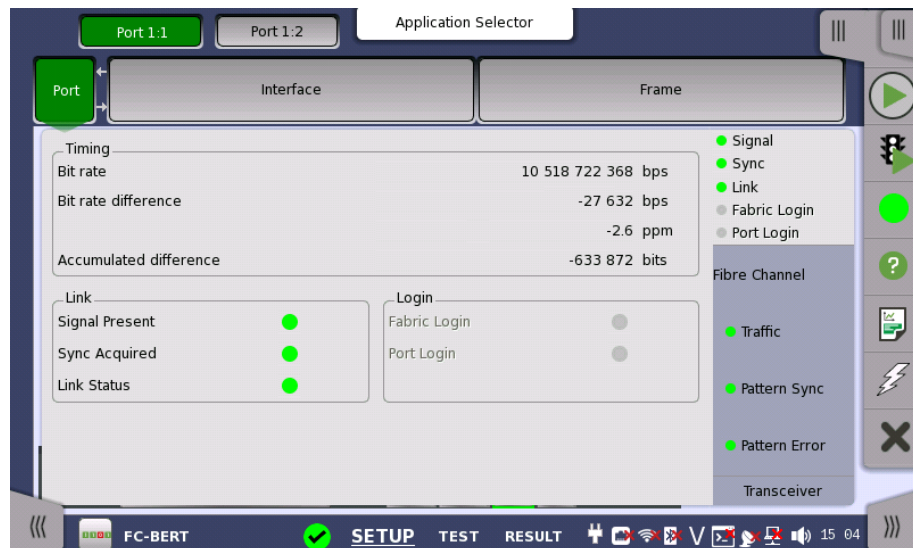

This screen presents information about the physical state and current state of the link.

Timing

Bit rate

The currently received bit rate is shown in bits per second (bps).

Bit rate difference

The current difference between the received signal's bit rate and the nominal bit rate is shown in both parts per million (ppm) and bits per second (bps).

Accumulated difference

The accumulated difference between the received signal's bit rate and the nominal bit rate is shown. The information is presented as the number of bits of difference detected over the accumulation period.



This is important information for identifying small frequency differences, which may not be visible by showing the current bit rate difference.

The accumulated difference information is accumulated continuously. The accumulation is reset when measurement is started or restarted.

Link

The link status information consists of the following parameters:

Signal Present

Indicates the detection/loss of a valid signal (bit synchronization).

Sync Acquired

Indicates word synchronization acquired/lost.

Link Status

Indicates the current link status.

Login**Fabric Login**

Lamp icon lit in green when login to an F-port.

ELP

Lamp icon lit in green when Exchange Link Parameters have been exchanged with an E-port.

Port Login

Lamp icon lit in green when login to an N-port.

9.1.3.3 Alarms and Errors

The middle summary box in the status area of the **Ports Setup** screen indicates alarms and errors. Status is indicated by the use of [colored Lamp icons](#).

- **Traffic:** Traffic is detected.
- **Pattern Sync:** Pattern Sync is detected.
- **Pattern Error:** Pattern Error is detected.

9.1.3.4 Transceiver

Refer to [Transceiver](#) in "Ethernet Setup and Status" section.

9.1.4 Errors/Alarms Insertion

This section describes the errors and alarms insertion for the Fibre Channel interface on the [Application toolbar](#).

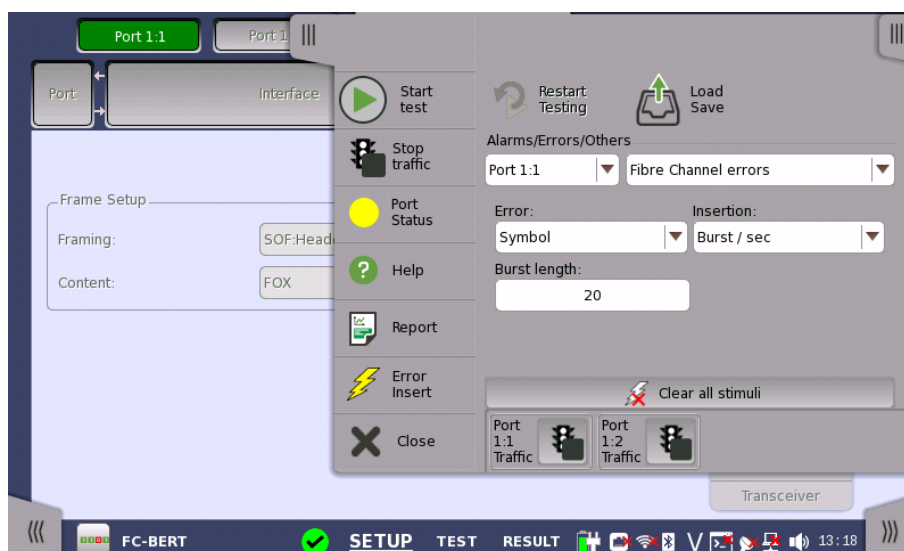

Alarms/Errors/ Others

Select the port to insert errors, and the stimuli type. The settings items vary depending on the selected stimulus type.

9.1.4.1 Fibre Channel alarms

Select an alarm option in the drop-down menu. Alarms will be inserted continuously.

- **None:** Does not insert alarms.
- **Link reset:** Inserts Link_Reset primitive sequences.
Ordered Set: K28.5 - D9.2 - D31.5 - D9.2
- **Link reset response:** Inserts Link_Reset_Response primitive sequences.
Ordered Set: K28.5 - D21.1 - D31.5 - D9.2
- **Not optional:** Inserts Not_Operational primitive sequences.
Ordered Set: K28.5 - D21.2 - D31.5 - D5.2
- **Offline:** Inserts Offline primitive sequences.
Ordered Set: K28.5 - D21.1 - D10.4 - D21.2

9.1.4.2 Fibre Channel errors

1. Select an error option in the **Error** drop-down menu.
 - **None:** Does not insert errors.
 - **Bit:** Inserts a bit error into the content part of FC frames.
 - **Symbol:** Inserts a symbol of 10 bit pattern which makes a 10b/8b conversion error.
When Port mode is set to **FC1200**, or **FC1600**, this option does not appear.
 - **R_RDY:** Inserts a Receiver_Ready primitive signal.
Ordered Set: K28.5 - D21.4 - D10.2 - D10.2
 - **CRC:** Inserts a bit error into CRC part of FC frames.
When Framing is set to **SOF:Header:EOF**, this option does not appear.
 - **Block:** Inserts an error block of 64b/66b transmission word.

When Port mode is set to **FC1200** or **FC1600**, this option appears.

2. In the **Insertion** drop-down list, select an insertion mode.
 - **Off**: Turns off inserting errors.
 - **Manual**: Inserts the specified number of errors if you touch the Error Insert icon.
 - **Burst / sec**: Inserts the specified number of errors in one second periodic.
 - **Burst / 10 sec**: Inserts the specified number of errors in ten second periodic.
 - **Burst*1E-02 to Burst*1E-07**: Inserts errors of burst length at the specified rate continuously.

For example, **Error burst length** is set to 3 and **Burst*1E-06** is selected, the three errors will be inserted per one million blocks. The Error Insert icon shows only status.

3. Touch the **Burst length** field to set the number of errors to insert.
4. When Insertion is set to **Manual**, touch the Error Insert icon.

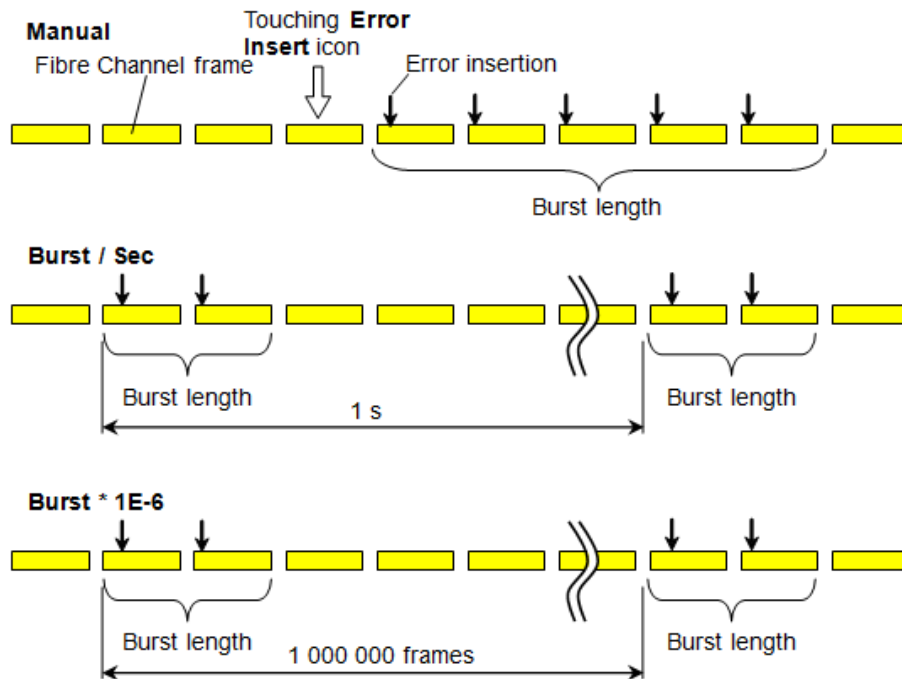

9.1.4.3 Fibre Channel frequency

Touch the field to set **Fibre Channel frequency**. Enter the desired deviation in the Tx Deviation field. A positive value increases the frequency.

9.2 BERT



BERT stands for Bit Error Rate Testing or BER Testing. The bit error rate is a key parameter in assessing systems that transmit digital data from one location to another (that is, systems such as radio data links, fiber-optic data systems, Ethernet etc.).

9.2.1 Ports Setup and Status

The first step in running an application is to set up the port interfaces. This is done on the **Ports Setup** screen, which also provides port status information.

The setup options and status information related to the Fibre Channel interface are described in a separate section:

- [FC Setup and Status](#)

For applications also including an OTN interface, you can find a description of the setup options and status information for OTN in the following section:

- [OTN Setup and Status](#)

Refer to the sections relevant for your current port setup requirements.

9.2.2 Test Setup

9.2.2.1 Control

When you go to the test setup of the Fibre Channel Bert application, the following screen is displayed.

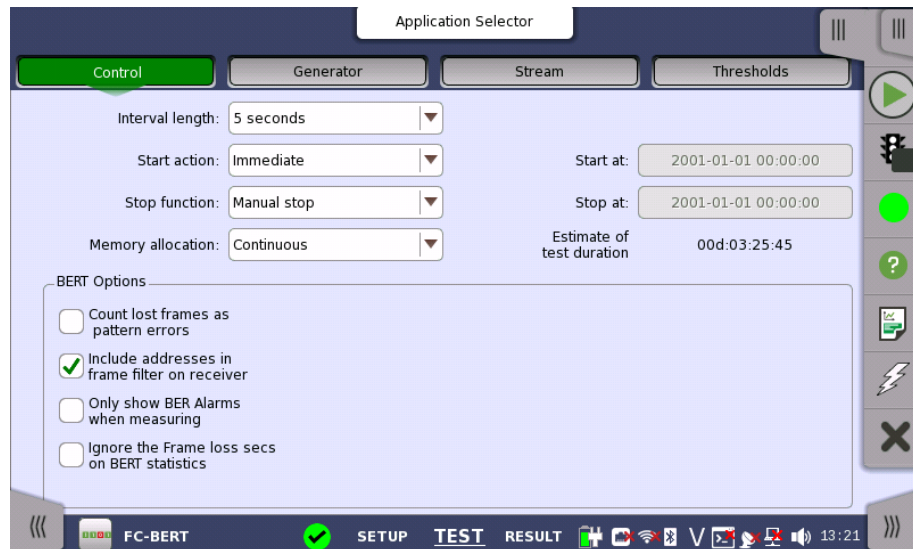

This screen contains the parameters that are generally required in a BERT test setup.

Interval length

Allows you to specify the duration of the BERT intervals. The drop-down menu contains the following values: 1, 2, 5, 10, 15, 30 seconds, 1, 5, 10, 15, 30 min., 1, 2, 4, 6, 12 hours or No Intervals.

Start action

Allows you to specify when the measurement is started.

- **Immediate:** Starts the measurement when you touch the **Start** button.
- **Start at:** Starts the measurement at the time specified in the **Start at** field on the right.

Stop function

Allows you to specify when the measurement ends. Select the relevant option from the drop-down menu:

- **Manual stop:** Stops the measurement immediately when you touch the **Stop** button.
- **Stop at:** Stops the measurement at the time specified in the **Stop at** field on the right.
- **Duration:** Performs the measurement for the duration of time specified on the right.

Memory allocation

Allows you to specify how the measurement will be stored in the Network Master's memory. Select the relevant option from the drop-down menu:

- **Use all storage:** When Network Master's memory became full of measured data, the whole measurement is stopped.
- **Continuous:** When Network Master's memory became full of measured data, the oldest records in that memory will be overwritten. When the memory became full, it is recorded in [Event log](#).

The Network Master's memory size (the file size of measurement results) is 64 Mbytes per one port. The result file size is less than 64 Mbytes because it is compressed when saving to the file.

Estimate of test duration

Contains an estimation of the time (in days, hours, minutes and seconds) before the whole memory will be filled out by the test. During an ongoing measurement, the estimate will be recalculated periodically.

Performance Parameters

These items appear if **OTN Tx** and **OTN Rx** are selected on Setup screen.

OTN

G.8201, M.2401 (M.2110)

Time period

15 minutes, 1 hour, 2 hours, 24 hours, 7 days

Allocation

Touching the **Setup** button launches the dialog box. Refer to [Performance Parameters](#) in "OTN Application" .

BERT Options**Count lost frames as pattern errors**

Enabling this function means that if a frame is lost, all test pattern bits in the frame are considered errored and will be included in the pattern error counter.

Include addresses in frame filter on receiver

The receiver uses a filter to determine which frames should be counted in the results. When this function is enabled, the following fields are required to match:

- Source ID
- Destination ID
- R_CTL (=0x00, Uncategorized FC-4)
- Type (=0xE0, vender unique type)

When this function is not enabled, the following fields are required to match:

- Most significant byte of R_CTL should be equal to 0. (FC-4 data)

Only show BER Alarms when measuring

BER alarms in Interface status dialog box is enabled only when the measurement is running. This function allows to avoid the BER alarms occurrence when no data is input.

9.2.2.2 Generator

Touching the **Generator** button in the navigation area displays the following screen.

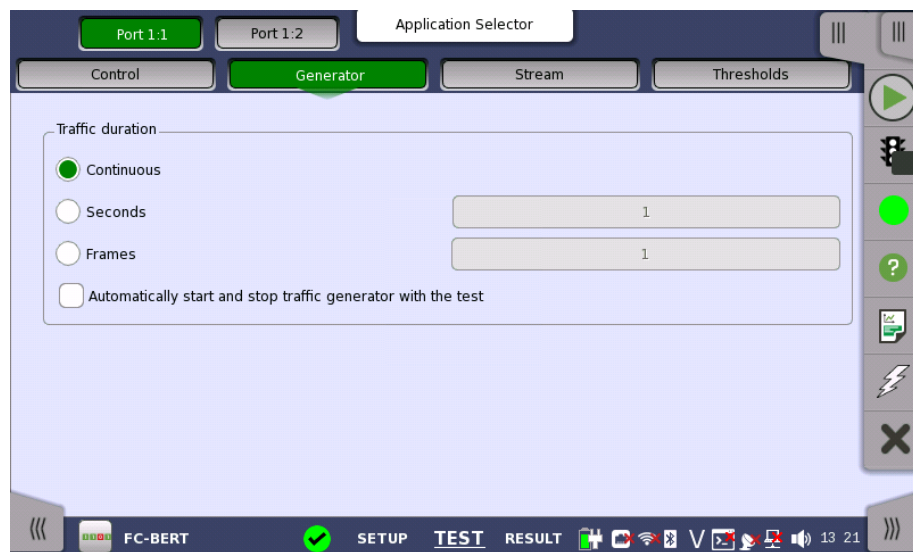

This screen contains the traffic-related parameters.

Traffic duration

Allows you to set conditions concerning frames transmission. Choosing **Continuous** will make a continual test sequence. Alternatively, the duration can be set manually in either **Seconds** or **Frames**, coupled with a specification of the number of seconds/frames in the adjacent field.

Automatically start and stop traffic generator with the test

Select this check box to make the traffic generator start and stop synchronously with the test starting/stopping.

9.2.2.3 Stream

Touching the **Stream** button in the navigation area displays the following screen.

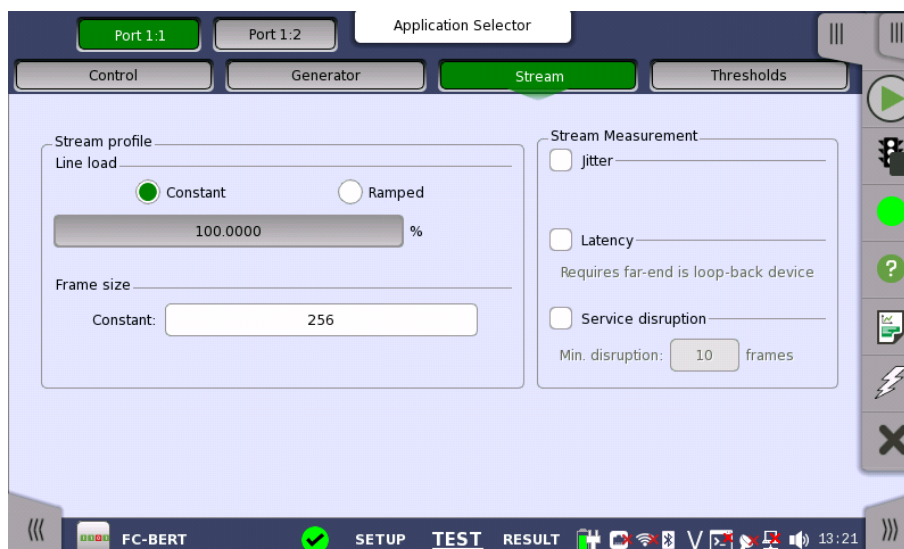

This screen contains the parameters for specifying a profile and pattern for each stream and for specifying which measurements are made.

Stream profile

Line load

Refer to "[Line load](#)" in "Ethernet Applications" for the operation.

Frame size

Touch **Constant** field to set the fixed frame size for the duration of the test.



*Frame size does not include byte counts of SOF and EOF.
Set the Frame size to a multiple of 4.*

Stream Measurement

Select one or more of the measurements (**Jitter**, **Latency** and **Service disruption**) on both of transmitter and receiver and then specify a threshold value for each.

If selecting Service disruption, specify the threshold frame count by touching **Min. disruption** field.

9.2.2.4 Thresholds

Touching the **Thresholds** button in the navigation area displays the following screen.

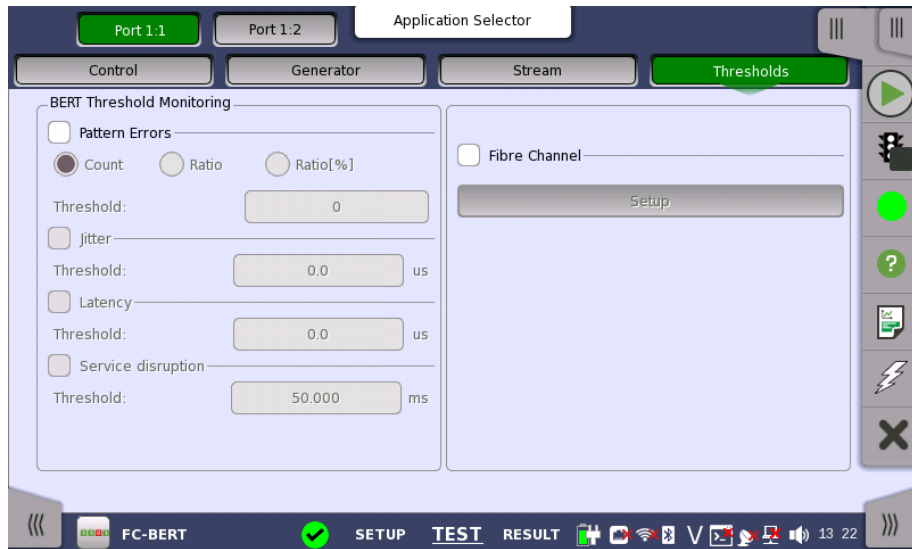

This screen contains the parameters for setting up the various threshold values (i.e. limits) for errors and Pass/Fail status that are used during the monitoring.

BERT Threshold monitoring

Pattern errors

Allows you to enable monitoring of pattern errors (i.e. bit errors) and to set up a threshold value for the bit error ratio.

Choose whether the threshold is specified as an absolute value or a percentage, using the **Count**, **Ratio** and **Ratio (%)** radio buttons, and then specify the value in the **Threshold** field.

Jitter, Latency, Service disruption

Select one or more of the measurements (**Jitter**, **Latency** and **Service disruption**) and then specify a threshold value for each. Any measurements whose maximum duration time exceeds the threshold value will be marked in red on the Test Result screen.

Fibre Channel

When you select the check box, you can enable various thresholds. Touch the **Setup** button to display the **Fibre Channel threshold setup** dialog box.

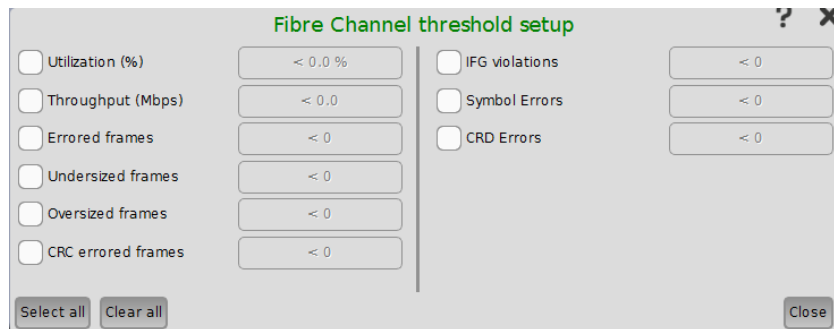

For setting example, refer to [Example](#) in "Ethernet threshold setup".

Transport

This setting appears in case of BERT on OTN.

When you select the check box, you can enable alarm or error thresholds.

Interface

Fixed to OTN.

Evaluation item

Select the item to evaluate. If selecting other than **Any Alarm or Error**, another menu appears.

Evaluation type

Select the relevant type.

Pass & fail threshold

Touch the left-hand number to set the lower limit for "Warning". Touch the right-hand number to set the lower limit for "Fail". The lower limit of "Fail" must be equal to or greater than the lower limit of "Warning" (defining a "Within limits" range in between them).

9.2.3 Test Results

9.2.3.1 Summary

When you go to the test results of the Fibre Channel BERT application, the following screen is displayed.

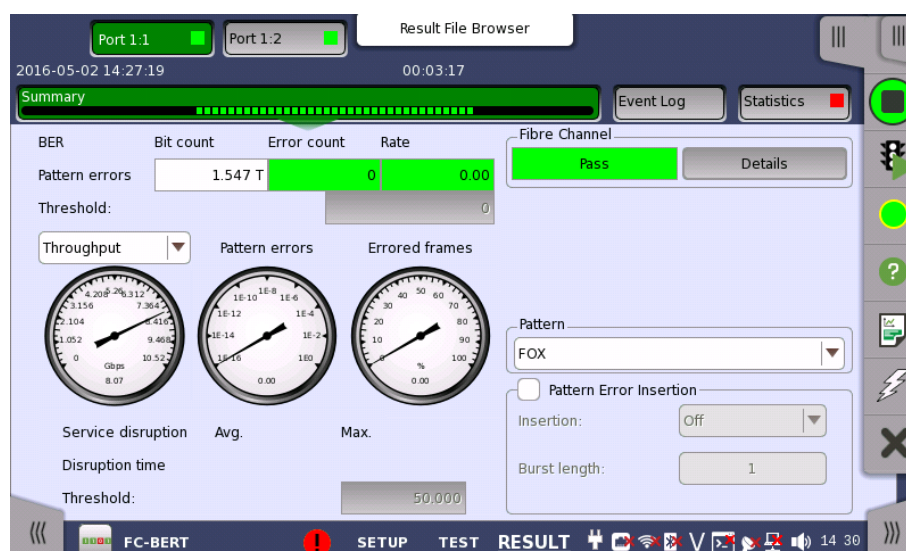

This screen contains a summary of the results of the Fibre Channel BERT test. The information includes such things as number of pattern errors, average and maximum disruption time, and number of exceeded thresholds.

The three dials showing utilization/throughput results, pattern errors and errored frames can be enlarged by touching on them. The black needle points the measured value in the latest period.

Refer to the [Summary](#) of BERT in "Ethernet Application".

Fibre Channel

When **Fibre Channel** is selected on 'Threshold' of the Test Setup screen, the **Fibre Channel** information appears in the upper right-hand corner, shows pass/fail status summary. Touching the **Details** button allows you to inspect the individual pass/fail status.

Pattern

Select the pattern.

Pattern Error insertion

This provides the same Error insertion as *Stimuli setup options* in [Application Toolbar](#).

Insertion

If selecting **Manual**, error(s) are inserted when you touch the **Alarm/Error Insert** (⚡).

Set **Off** to stop the error insertion.

Burst length

If 'Insertion' is set to **Manual**, touch the button and set the number of errors to insert.

9.2.3.2 Event Log

Touching the **Event Log** button in the navigation area displays the screen providing the event log data. Refer to [Event Log](#) of SDH/SONET/PDH/DSn BERT application.

9.2.3.3 Statistics

Touching the **Statistics** button in the navigation area displays the screen shown below.

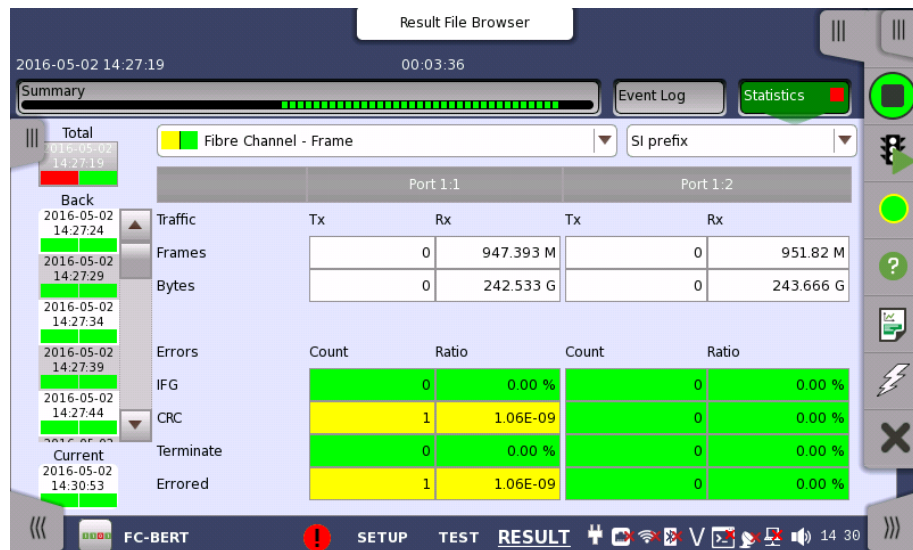

This screen presents a detailed analysis of the test results. You can choose to view either the results of a specific time interval or the total results from measurement start. The results can be displayed either in table (list) form or as graphs. You can also zoom in on a specific result item and display either a zoom or a histogram.

Selecting which results to view

Selecting the interval time

Touch the **Total** button to switch the total values measured in all interval times. The start time of measurement is displayed on the button.

Touching the button in left side **Back** field shows the measured values in the interval time. The end time of the interval is displayed on the button.

Current button is displayed at left bottom when the measurement is running. Touching the **Current** button shows the measured values in the current interval time. The start time of the current interval is displayed on the button.

The slide-out panel on the left-hand side of the screen contains the following functions:

- Only show intervals that contains errors
- Time format

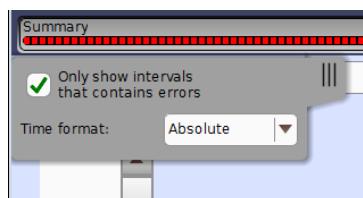

*If you have stopped measurement during the interval time, the measurement results of the current interval are discarded. The log of the current interval is not displayed in **Back** field.*

In this case, result data are re-calculated excluding the data of the current interval when the measurement is stopped. This causes that "Count" and "Ratio" displayed after the measurement will be different from that of during measurement.

The sum of interval time (multiplied interval time by the number of back logs) may not match the differential time between displayed time at left top and right top after the measurement.

Selecting type of results

Open the left drop-down menu in the top row of buttons to select which results you want to display on the screen.

- OTN - Alarms/Errors
- OTN - Performance
- BERT or Reflector (Depends on application)
- Link
- Frame
- Performance
- Size Distribution

OTN options appear if the FC signal is carried by OTN.

Studying a specific result

Touch a specific cell in a result table to zoom in on the corresponding result item. The **Count** and **Ratio** fields are displayed on a **Zoom** tab page. A **Time vs. Statistics** tab page is also available. Use the **Back** button or touch the zoom filed to return to the statistics screen.

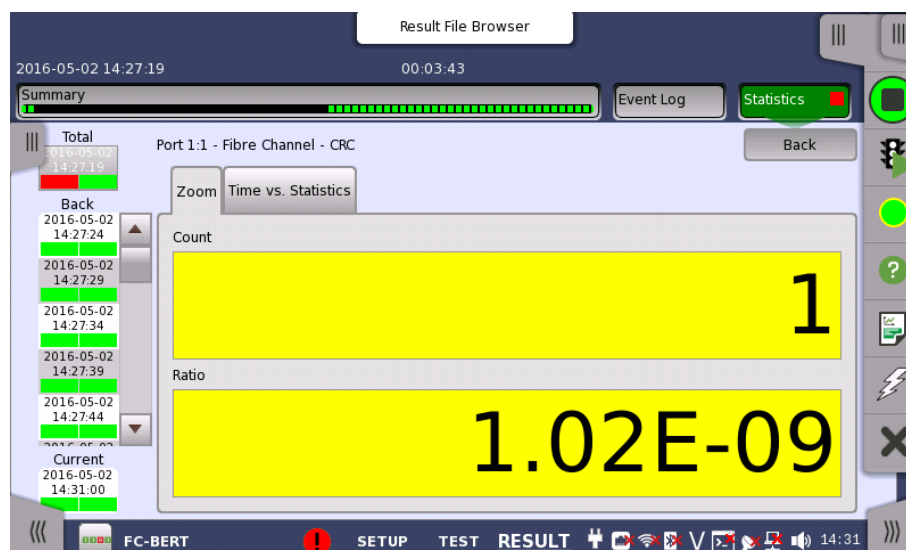

Selecting how results are displayed

Selecting notation

Select the required notation for the results from the notation drop-down menu.

- **Unformatted** - e.g. 71892
- **SI prefix** - e.g. 71.891 k (k means "kilo")
- **Engineering** - e.g. 71.892E3
- **Scientific** - e.g. 7.1892E4

Results

Results are displayed according to your choice.

OTN Alarms/Errors	Refer to Results in "OTN Application"
OTN Performance	Refer to Results in "OTN Application"
BERT Results	BER Latency Jitter Service Disruption
Reflector Results	Reflected Frames Reflected Bytes Not Reflected Frames Not Reflected Bytes Total Frames Total Bytes
Link Results	Symbol Errors Block Errors Ordered Sets
Frame Results	Traffic Errors Others
Performance Results	Line rate Frame rate Utilization Throughput
Size Distribution Results	Size Dist. Frame Size

Abbreviation

The following abbreviations are used in the description of Link results.

LR	Link Reset
LRR	Link Reset Response
NOS	Not Operational
OLS	Offline
RF	Remote Fault
R_RDY	Receiver Ready

Frame Errors

The following items are displayed in the error count of Frame results.

IFG	Number of frames with inter-frame gap error.
CRC	Number of frames with CRC errors.
Symbol	Number of frames with 10B code errors.
CRD	Number of frames with CRD errors. CRD errors are when the EOF polarity does not match the current disparity.
Terminate	Number of frame with which have been terminated either with unknown ordered sets value or with an EOFa.
Errored	Number of frames which have one of Symbol, Terminate, CRC, or CRD errors.

9.3 Performance



The FC Performance test is one of the methods to evaluate the network quality and defines many tests to determine the performance characteristics of the network device or entire network. Network Master includes several physical setups (test modes) and five different tests.

Throughput Test

The throughput is the maximum rate at which a DUT (Device Under Test) can forward frames without frame loss for a specific frame size. That is, the maximum rate at which the number of test frames sent by the DUT is equal to the number of test frames sent to it by the test equipment.

Traffic Profile Test

Traffic Profile Test measures actual throughput with varying the line load in up to ten steps. For each selected frame size, a set of throughput steps defined by user will run and actual measured throughput will be recorded.

Latency Test

Latency Test is the delay time from sending the frame from Network Master to returning the frame to Network Master. This test measures the latency when frames are sent at maximum throughput measured in Throughput Test. The latency dispersion is measured as jitter.

To run this test, it is required to perform Throughput Test at the same time.

Burst Test

Burst Test measures the number of frames in the longest burst that the DUT will handle without the loss of any frames.

Credit Test

Credit Test measures the minimum credit value that can output the maximum throughput measured in Throughput Test.

To run this test, it is required to perform Throughput Test at the same time.

9.3.1 Ports Setup and Status

The first step to run an application is to set the port interfaces. Set the port interfaces in the **Ports Setup** screen, which also provides the port status information.

The setup options and status information related to the Fibre Channel interface are described in the following section:

- [FC Setup and Status](#)

For applications also including an OTN interface, refer to the setup options and status information for OTN in the following section:

- [OTN Setup and Status](#)

Refer to the sections corresponding to the required port setup.

9.3.2 Test Setup

Restriction of Number of Steps

FC Perf. measures the throughput, traffic profile, latency, burst, and BB credit count while changing the load applied to the DUT by changing the transmission rate and size of the Ethernet frame. In addition to the final results, Network Master retains the measurement results at each load as an intermediate results, but 500 steps are retained at maximum. Depending on the setting of the steps, it is possible to retain more than 500 steps, but in that case the oldest measurement result(s) will be discarded.

Also, depending on the setting, only the results of one category (throughput, traffic profile, latency, burst, or BB credit count) may be retained in large amount disproportionately. In order to avoid this, Network Master organizes the results so that results at least 100 steps remain as shown in the examples below.

However, Traffic Profile and Credit (when BB Credit Count is set to **Stepped**) start the next test when the number of steps has reached the number of measurable steps.

Example 1

Test	Number of Steps set in Setup	Number of steps in which the measurement results are retained
Throughput	100	100
Burst	200	200
Credit	500	200*

*: The test is stopped when the 200th step is measured because the number of total steps reaches 500.

Example 2

Test	Number of Steps set in Setup	Number of steps in which the measurement results are retained
Throughput	500	300 ^{*1}
Burst	200	100 ^{*2}
Credit	100	100

*1: Measurement results for the first 200 steps are discarded.

*2: Measurement results for the first 100 steps are discarded.

In the test setting, the total number of steps can be set to more than 500. In this case, a warning is displayed on the [Summary](#) screen when the measurement is started.

The number of test steps can be calculated by the following formula.

$$\text{Number of steps} = f \times l$$

f: Number of Frame Size steps

l: Number of Line Load steps

In the following setting example, the number of steps is 50.

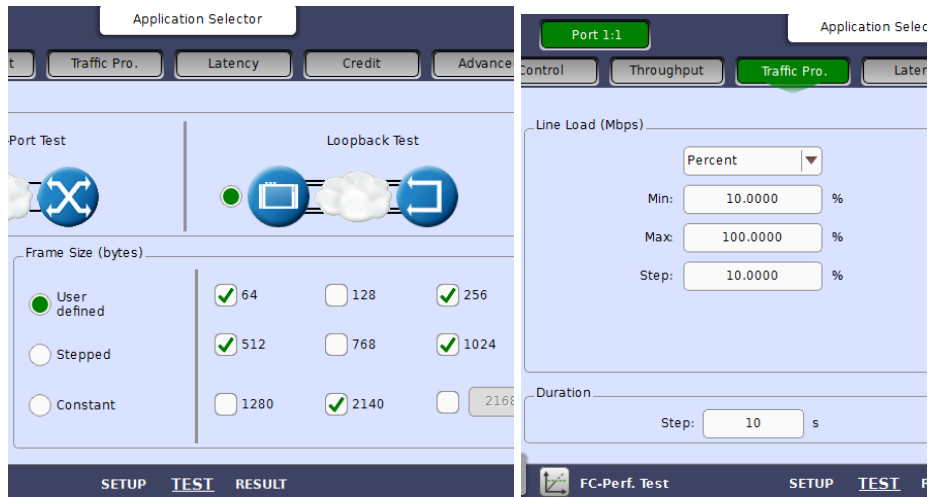

f=5 Five frame sizes, 64, 256, 512, 1024, and 2140 bytes are selected.
 l=10 With the settings of Min. 10%, Max. 100%, and Step 10%, line load steps are ten, 10%, 20%, 30%, 40%, 50%, 60%, 70%, 80%, 90%, and 100%.
 Number of steps = $f \times l = 5 \times 10 = 50$

9.3.2.1 Control

The following screen is displayed by touching **Control** in the Navigation area.

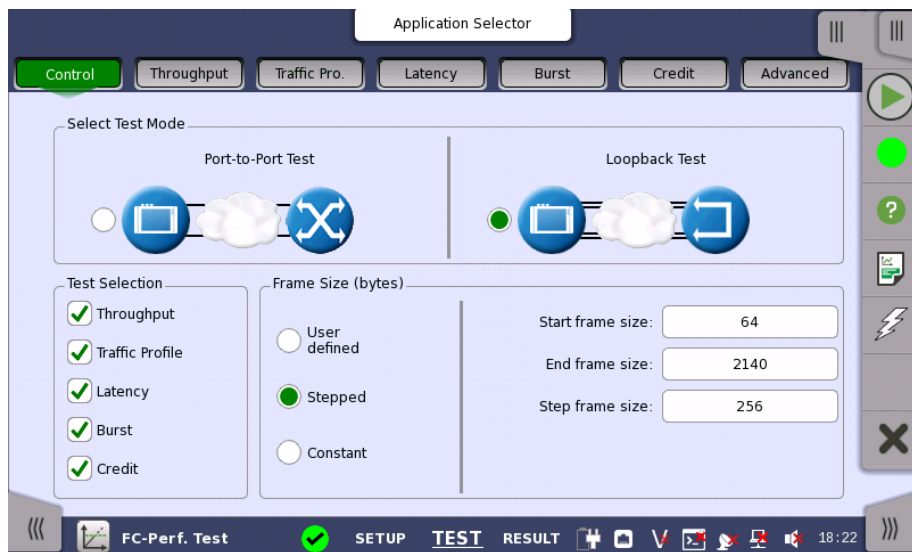

Specify the test mode and select the test to be performed in this screen.

Select Test Mode

Two different test modes are available:

- [Port to Port Test](#)
- [Loopback Test](#)



Port to Port Test uses two ports to perform tests. When only one port is selected at starting Performance Test application, it is not able to start Port to Port Test.

Select the test mode to define your test configuration. Refer to [Test Mode Descriptions](#).

Test Selection

Select one or more of the following [tests](#):

- [Throughput](#)

- [Traffic Profile](#)
- [Latency](#)
- [Burst](#)
- [Credit](#)



When a test is selected, the test setup screen including the setup parameters related to the test can be used. Similarly, the test results include only the test selected at Test Selection.

Test Mode Descriptions

Port to Port test



In this test mode, the facing test of Network Master and the FC instrument is performed.

Loopback test



This test is used when testing network by reflecting traffic back to the Network Master. This requires a device to reflect the traffic back e.g. a second Network Master.

Frame Size (Bytes)

There are three methods to specify the size of the fibre channel frame sent during the test.



Frame Size (Bytes) is a byte length from header to CRC. It does not include SOF and EOF.

User defined

Check the check box and select the following frame size:

64, 128, 256, 512, 768, 1024, 1280, 2140, and 2168 to 3240 (Set the frame size using the field at the right bottom.)

Stepped

Set **Start frame size**, **End frame size** and **Step frame size**. The frame size is started from the value set at **Start frame size**, and increased/decreased until the value set at **End frame size** at intervals of the value set at **Step frame size**.



Set the parameters so that the number of frame sizes is ten or less. When the number of frame sizes is 11 or more, the message "Maximum of 10 frame sizes is allowed." is displayed.

Example:

Start frame size: 100, End frame size: 1500, Step frame size: 100

In this case, the number of frame sizes is 15 (100 to 1500). Measurements are performed for the frame sizes from 100 to 1000, not for 1100 to 1500.



The Stepped mode is useful when testing various frame sizes that are distributed consistently and equally. As a consequence, it produces more smooth and detailed graphs when a low value is set at Step frame size. When the step frame size is lower, the measurement time is longer.

Constant

Set a value at **Frame size**.

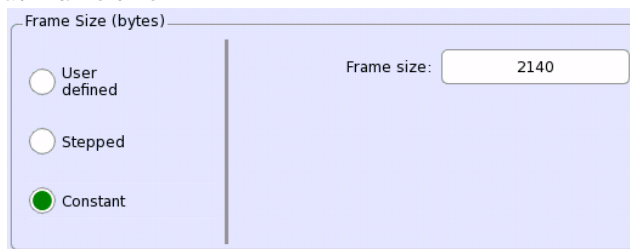

9.3.2.2 Throughput

The following screen is displayed by touching **Throughput** in the Navigation area.

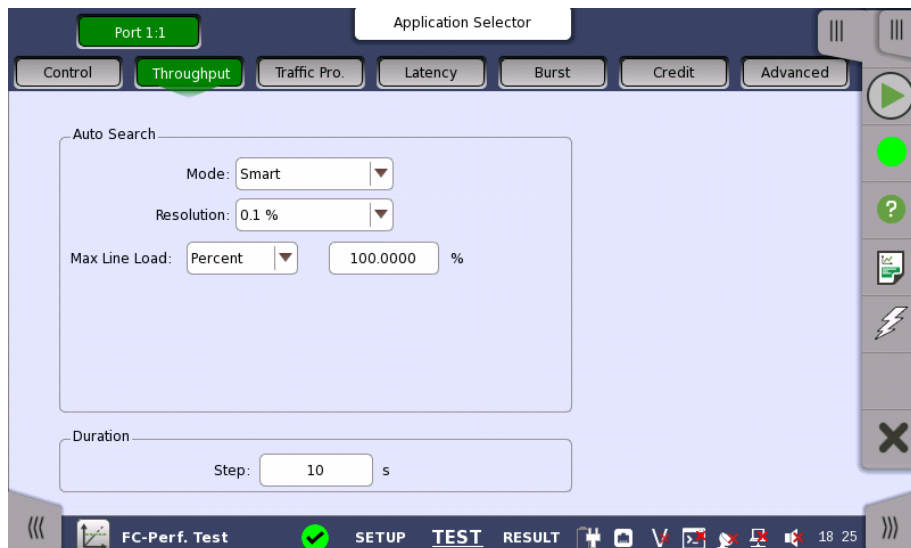

Auto Search

Mode

Select the search method.

- **Smart:** It is assumed that occurring the frame loss is a higher probability around Max. And the skewed binary searching is performed. (The area where the line loads is high is searched at first.)
- **Binary:** The binary searching of the line load interval specified in the range from Max to Min is performed.

Resolution

Select an Auto search resolutions from **0.1**, **1.0** or **10.0** %.

Max Line Load

Set the maximum line load of Auto search. The unit is **Percent** or **Mbps**.

Duration

Step

Specify an approximate duration for each step of the test by time.

9.3.2.3 Traffic Profile

The following screen is displayed by touching **Traffic Profile** in the Navigation area.

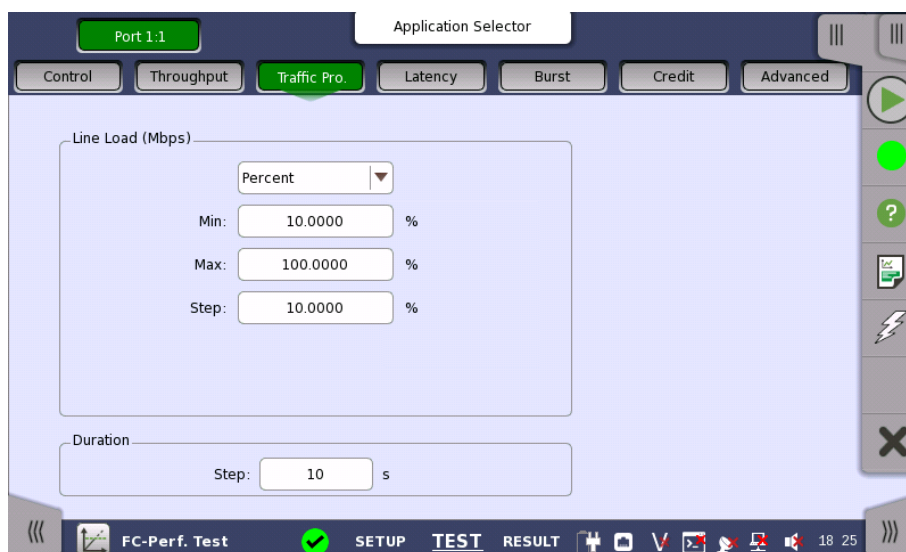

Line Load

Set a line load of the Traffic Profile test. The unit is **Percent** or **Mbps**.

Duration

Step

Specify an approximate duration for each step of the test by time.

9.3.2.4 Latency

The following screen is displayed by touching **Latency** in the Navigation area.



Duration

Step

Specify an approximate duration for each step of the test by time.

9.3.2.5 Burst

The following screen is displayed by touching **Burst** in the Navigation area.

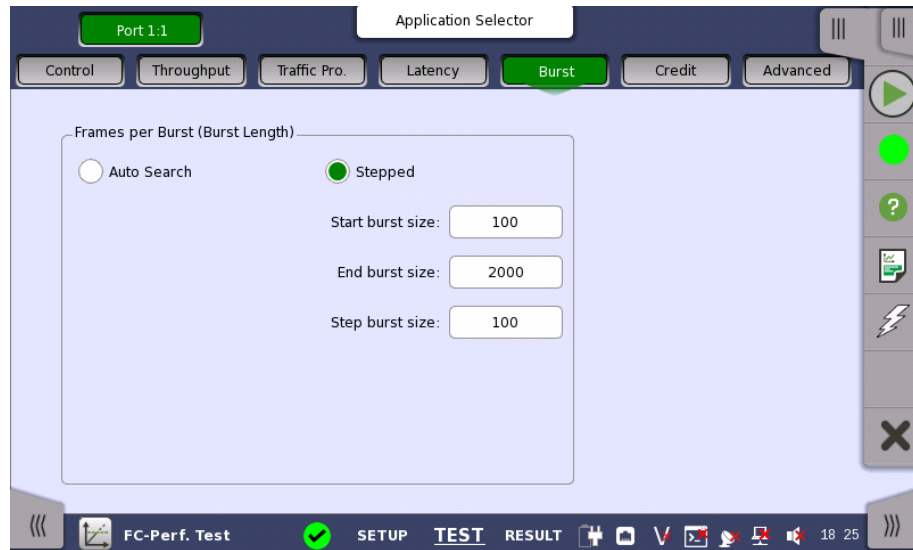

Frames per Burst (Burst Length)

Auto Search

When the check box is selected, the burst length is automatically searched. Select Search Mode. The resolution is selected from **1**, **10**, or **100**.

The range of searching the burst size is set at **Start burst size** and **End burst size**.

Stepped

The burst size is changed in steps. The range of changing the burst size is set at **Start burst size** and **Stop burst size**. And the change amount per step is set at **Step burst size**.

When the burst size is set as follows, it is changed from 100 to 900 (100 -> 300 -> 500 -> 700 -> 900).

Start burst size: 100

End burst size: 1000

Step burst size: 200

9.3.2.6 Credit

The following screen is displayed by touching **Credit** in the Navigation area.

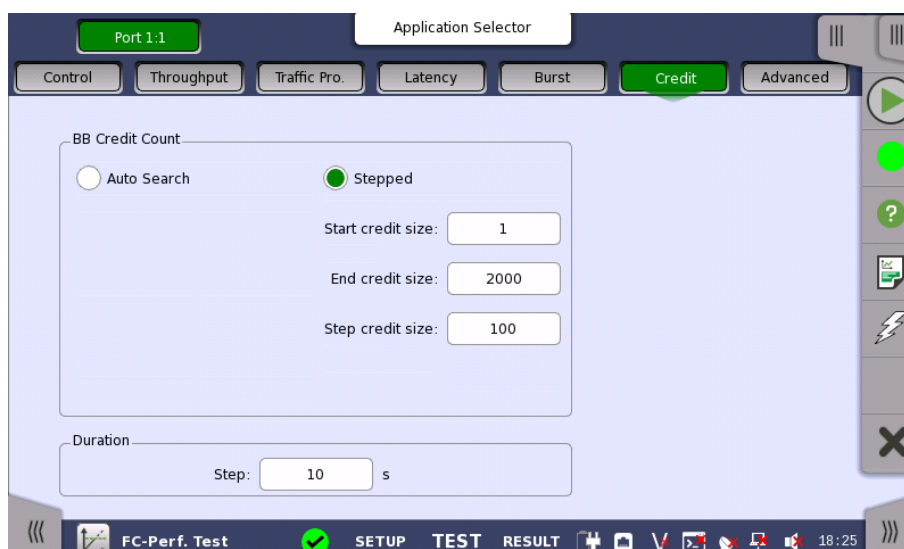

BB Credit Count

BB Credit Count (buffer-to-buffer Credit_Count) is a counter used for Buffer-to-buffer flow control management

BB Credit Count is defined as the number of unacknowledged or outstanding frames awaiting R_RDY responses from the directly attached Fibre Channel Port.

Auto Search

The minimum local credit that realizes the maximum throughput is searched in the range from 1 to the number set at **End credit size**. However, the minimum local credit is not searched in the range that is three times or more of the remote credit size.

Select Search Mode. The resolution is selected from **1**, **10**, or **100**.

Stepped

BB Credit Count is changed in steps. The range of changing BB Credit Count is set at **Start credit size** and **End credit size**. And the change amount per step is set at **Step credit size**.

When BB Credit Count is set as follows, it is changed from 100 to 900 (100 -> 300 -> 500 -> 700 -> 900).

Start credit size: 100
End credit size: 1000
Step credit size: 200

Duration

Step

Specify the approximate duration in time of each step of the test.

9.3.2.7 Advanced

The following screen is displayed by touching **Advanced** in the Navigation area.

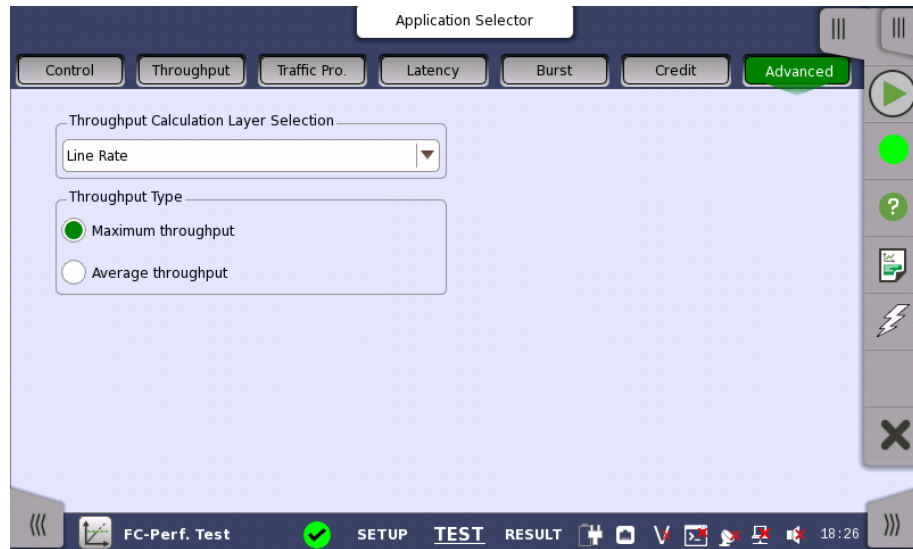

This screen sets the measurement method of *Measured Throughput* for the results of subsequent tests. The displays of the measurement results are not changed even if the Advanced settings are changed after completing the measurement.

Throughput, Traffic Profile, Latency, and Credit

Throughput Calculation Layer Selection

- **Line Rate:** For 1Gb/s to 8Gb/s, the throughput is calculated after encoding 8B/10B. For 10Gb/s, the throughput is calculated after encoding 64B/66B.
- **L1:** Layer 1. For 1Gb/s to 8Gb/s, the throughput is calculated before encoding 8B/10B. For 10Gb/s, the throughput is calculated before encoding 64B/66B.
- **L2:** Layer 2. Data field in FC frame.

Throughput Type

A throughput is measured in every one second. For example, when a test step is ten seconds, a throughput is measured ten times during one step.

When **Maximum throughput** is selected, the maximum value of the measured values in all steps is set as the test result.

When **Average throughput** is selected, the average value of the measured values in all steps is set as the test result.

9.3.3 Test Results

Graphical representation

The results of the performed FC Performance tests can be presented in either tabular form or as graphical representations. The graphical representation mode provides an overview of the results and the progress of the test.

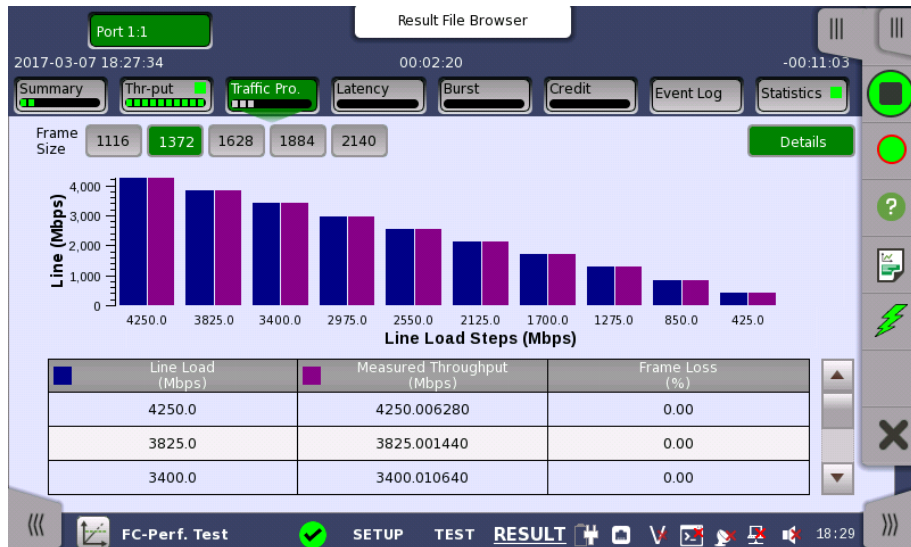

Two modes can be switched using **Detail** or **Summary**.

9.3.3.1 Summary

The following screen is displays by touching **Summary** in the Navigation area.

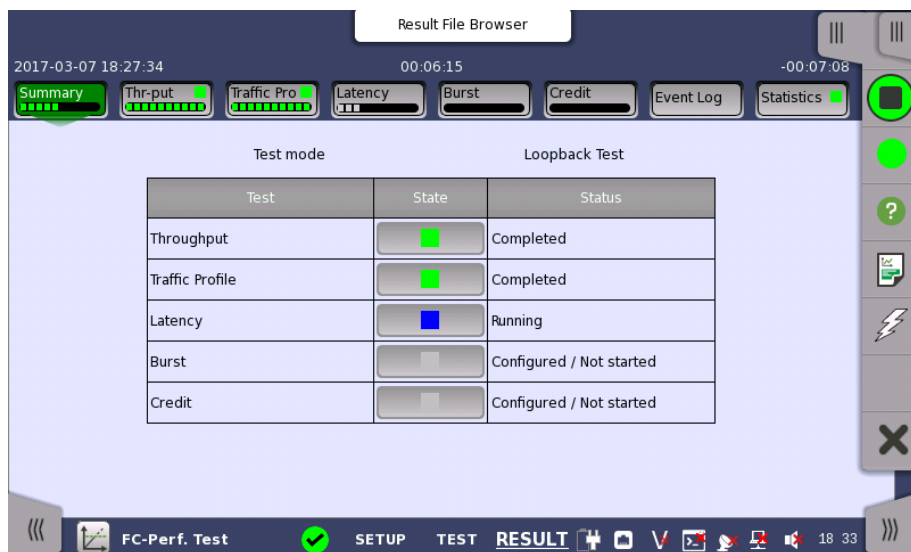

This screen presents the current status of the test(s) (**Configured / Not started**, **Running**, **Completed** or **Not Configured**). Touching the State button of the specific test displays the screen where the detailed result information is displayed.

9.3.3.2 Throughput

The following screen is displayed by touching **Throughput** in the Navigation area.

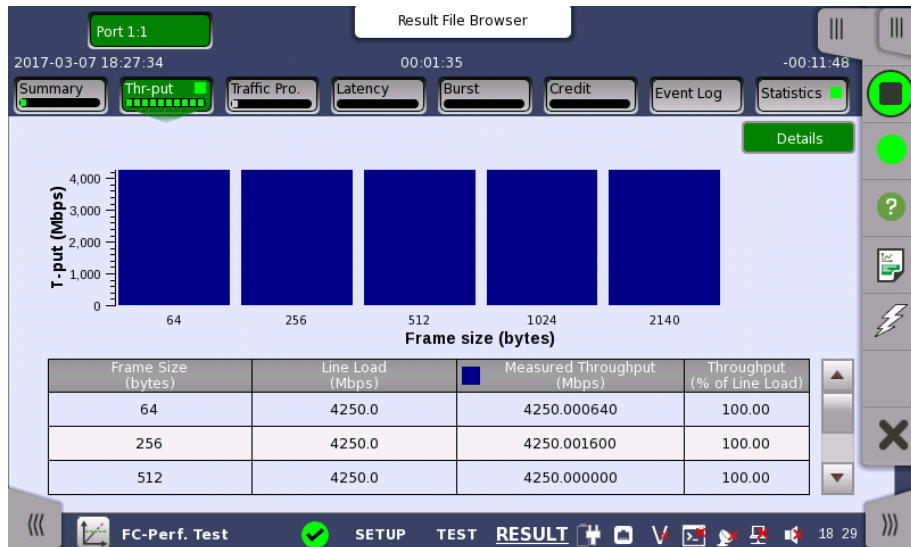

This screen displays the results of the Throughput test.

The measured throughput values are shown in a bar chart.

The following items are displayed in the result table.

- Step: Step numbers in Throughput test
- Fr size: Frame size defined in Control screen
- Frames: Number of sent frames
- Frame rate: Number of frames sent per second
- Util: Utilization in percent
- Load: Number of bits sent per second
- Act Load / Tput: Number of frames received per second
This is a measured throughput.
- Frames lost: Difference between sent frame count and received frame count

9.3.3.3 Traffic Profile

A screen similar to [Throughput](#) is displayed by touching **Traffic Profile** in the Navigation area.

This screen displays the results of the Traffic Profile test.

The line load and measured throughput values are shown in bar charts.

The following items are displayed in the result table.

- Step: Step numbers in Throughput test
- Fr size: Frame size defined in Control screen
- Frames: Number of sent frames
- Frame rate: Number of frames sent per second
- Util: Utilization in percent
- Load: Number of bits sent per second
- Act Load / Tput: Number of frames received per second
This is a measured throughput.
- Frames lost: Difference between sent frame count and received frame count
- Loss rt: Frame loss ratio in percent

It is calculated using the following formula:

$$\text{Loss ratio} = \frac{\text{Frame lost} \times 100}{\text{Frames}}$$

9.3.3.4 Latency

A screen similar to [Throughput](#) is displayed by touching **Latency** in the Navigation area.

This screen displays the result of Latency test.

The latency and measured jitter are shown in bar charts.

The following items are displayed in the result table.

- Step: Step numbers in Throughput test
- Fr size: Frame size defined in Control screen
- Frames: Number of sent frames
- Frame rate: Number of frames sent per second
- Util: Utilization in percent
- Load: Number of bits sent per second
- Act Load / Tput: Number of frames received per second
This is a measured throughput.
- Latency: Delay time of frames
- Jitter: Latency time variation

9.3.3.5 Burst

A screen similar to [Throughput](#) is displayed by touching **Burst** in the Navigation area.

This screen displays the result of Burst test.

The maximum burst length is shown in a bar chart.

The following items are displayed in the result table.

- Step: Step numbers in Throughput test
- Fr size: Frame size defined in Control screen
- Frames: Number of sent frames
- Burst size: Number of frames per Burst
- Back Pressure: Utilization in percent
- Frames lost: Difference between sent frame count and received frame count

9.3.3.6 Credit

A screen similar to [Throughput](#) is displayed by touching **Credit** in the Navigation area.

This screen displays the result of Credit test.

The measured throughput is shown in a bar chart.

The following items are displayed in the result table.

- Step: Step numbers in Throughput test
- Fr size: Frame size defined in Control screen
- Credit Size: Sent value of BB credit count
- Frame rate: Number of frames sent per second
- Util: Utilization in percent
- Load: Number of bits sent per second

- Act Load / Tput: Number of frames received per second
This is a measured throughput.
- Frames lost: Difference between sent frame count and received frame count

9.3.3.7 Event Log

Touching the **Event Log** button in the navigation area displays the screen providing the event log data. Refer to [Event Log](#) of SDH/SONET/PDH/DSn BERT application.

9.3.3.8 Statistics

Touching the **Statistics** button in the navigation area displays the screen providing the statistics data. Refer to [Statistics](#) of BERT for the operation.

9.4 Reflector



In *Fibre Channel Reflector* mode, the Network Master loops incoming traffic on a port, swapping ID addresses.

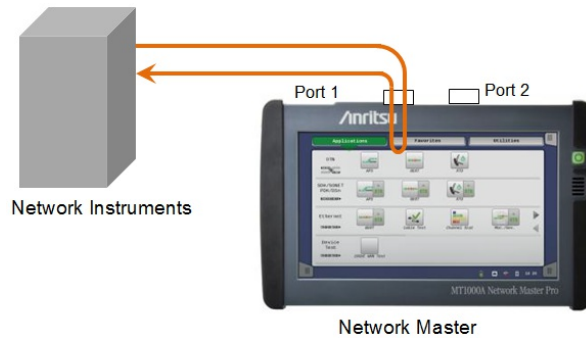

9.4.1 Ports Setup and Status

The first step in running an application is to set up the port interfaces. This is done on the **Ports Setup** screen, which also provides port status information.

The setup options and status information related to the Fibre Channel interface are described in a separate section:

- [FC Setup and Status](#)

For applications also including an OTN interface, you can find a description of the setup options and status information for OTN in the following section:

- [OTN Setup and Status](#)

Please refer to the sections relevant for your current port setup requirements.

9.4.2 Test Setup

9.4.2.1 Control

When you go to the test setup of the Fibre Channel Reflector application, the following screen is displayed.

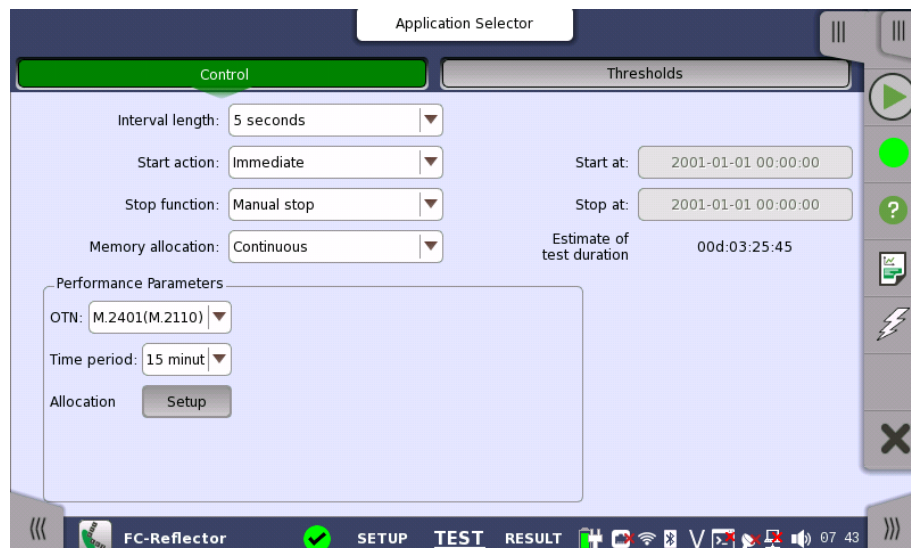

For operation, refer to [Control](#) in "BERT" section.

9.4.2.2 Thresholds

Touching the **Thresholds** button in the navigation area displays the following screen.

The **Follow** button appears when the Port 2 settings can follow Port 1.

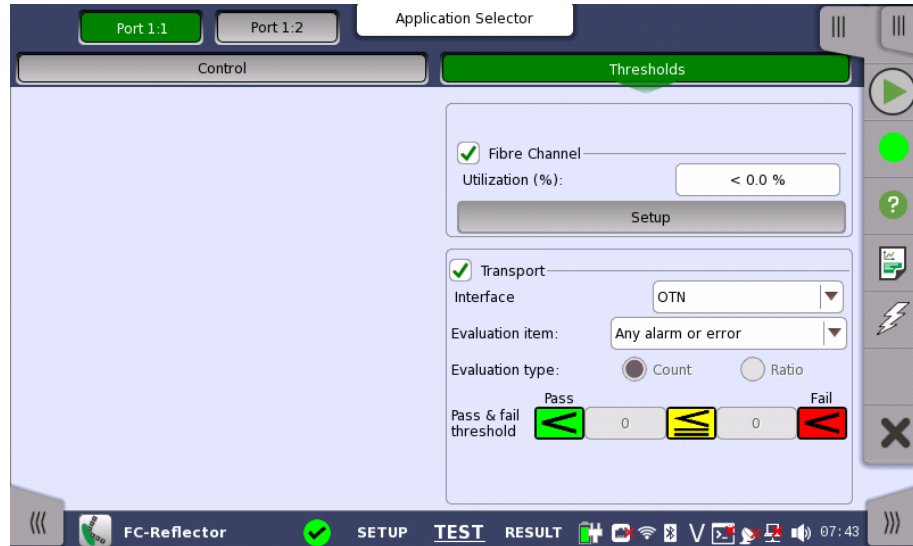

Transport settings appear if the FC signal is carried by OTN.

For operation of **Fibre Channel** and **Transport**, refer to [Thresholds](#) in BERT section.

9.4.3 Test Results

9.4.3.1 Summary

When you go to the test results of the Fibre Channel Reflector application, the following screen is displayed.

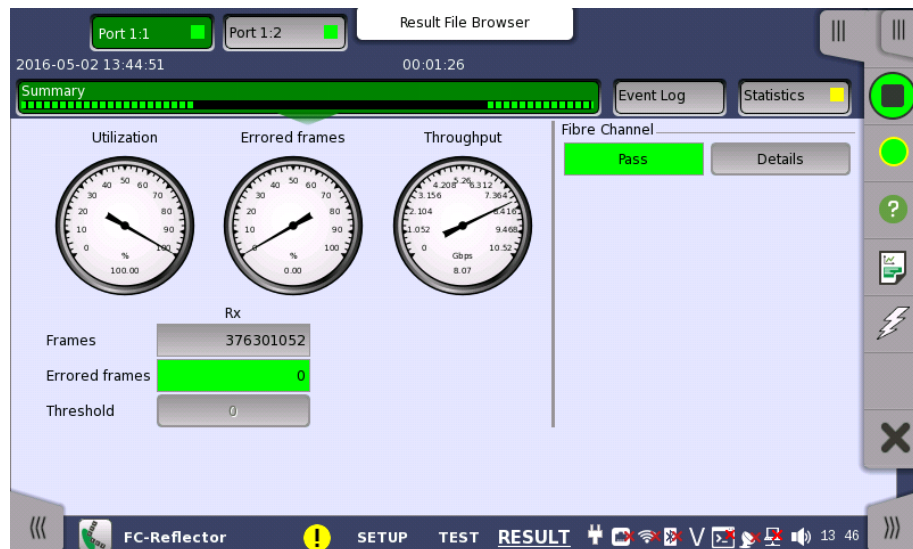

This screen contains a summary of the results of the FC Reflector test. The information includes such things as number of errored frames and number of exceeded thresholds.

The three dials showing Utilization, Errored frames and Throughput results. Utilization, Errored frames and Throughput can be enlarged by touching on them. The black needle points the measured value in the latest period.

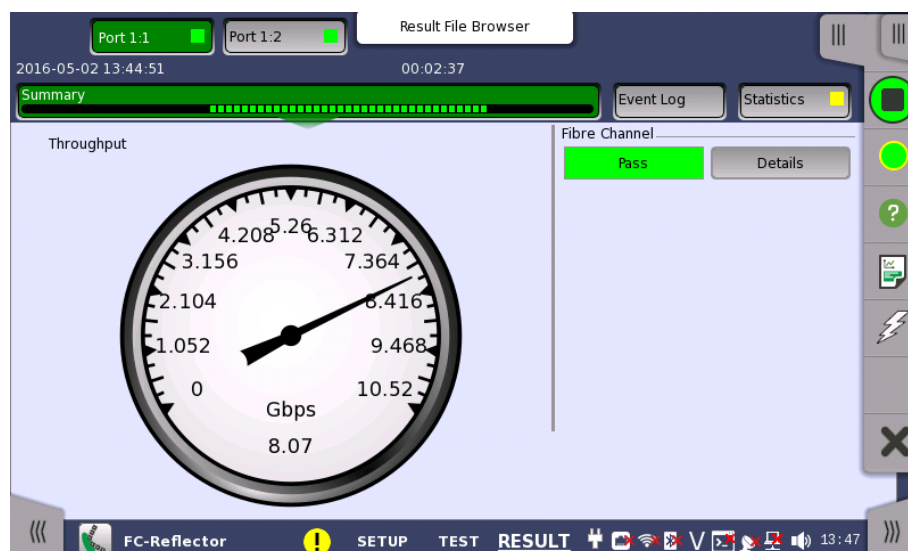

When **Fibre Channel** is selected on 'Threshold' of the Test Setup screen, the **Fibre Channel** information appears in the upper right-hand corner, shows pass/fail status summary. Touching the **Details** button allows you to inspect the individual pass/fail status.

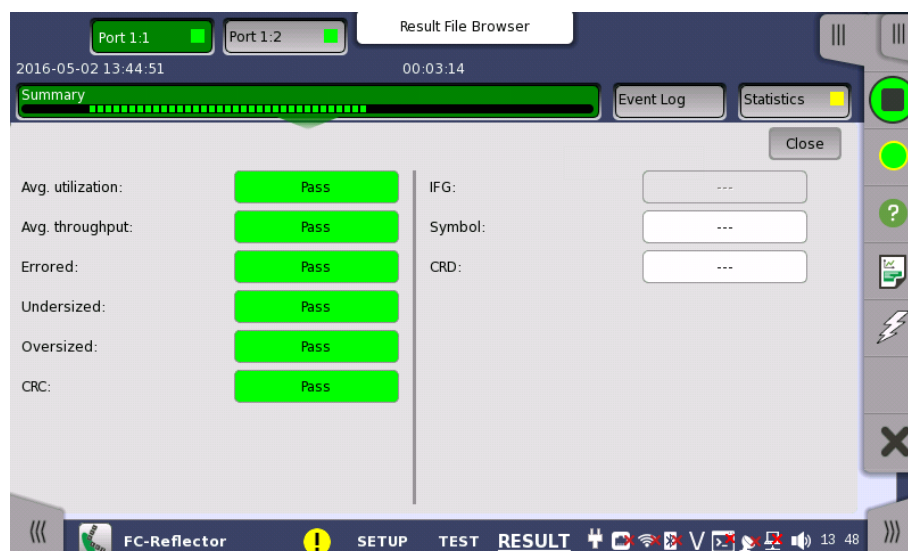

Transport

Displays the results of Transport test. This result appears if 'Transport' check box is selected in the Test Setup screen.

9.4.3.2 Event Log

Touching the **Event Log** button in the navigation area displays the screen providing the event log data. Refer to [Event Log](#) of SDH/SONET/PDH/DSn BERT application.

9.4.3.3 Statistics

Touching the **Statistics** button in the navigation area displays the screen shown below.

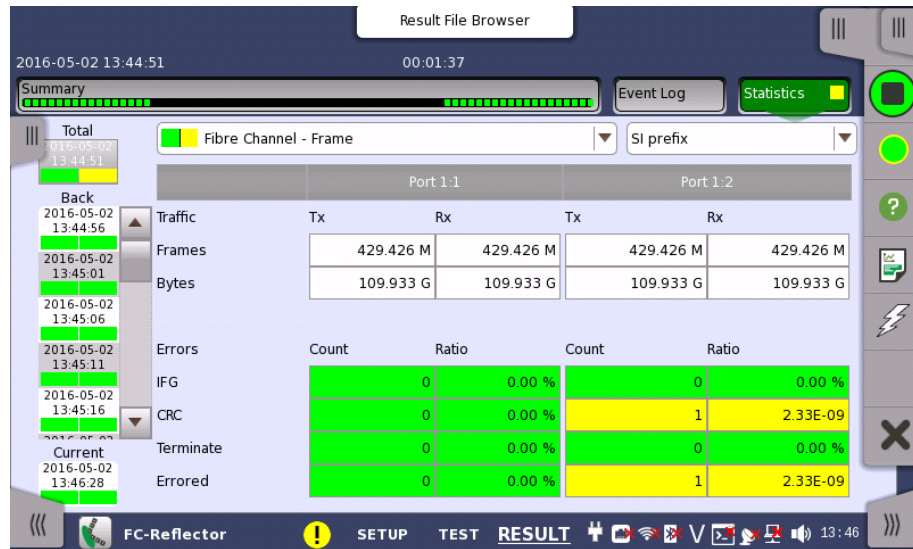

This screen presents a detailed analysis of the test results. You can choose to view either the total results from measurement start or the results of a specific interval during the test. You can also zoom in on a specific result item. The results can be displayed either in table (list) form or as a graph.

Selecting which results to view

Interval or total results Touch the **Total** button to switch the total values measured in all interval times. The start time of measurement is displayed on the button.

Touching the button in left side **Back** field shows the measured values in the interval time. The end time of the interval is displayed on the button.

Current button is displayed at left bottom when the measurement is running. Touching the **Current** button shows the measured values in the current interval time. The start time of the current interval is displayed on the button.

The slide-out panel on the left-hand side of the screen contains the following functions:

- Only show intervals that contains errors
- Time format

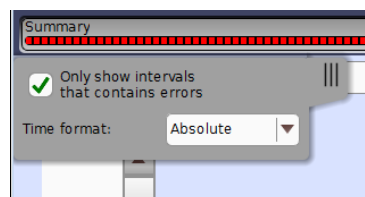



*If you have stopped measurement during the interval time, the measurement results of the current interval are discarded. The log of the current interval is not displayed in **Back** field.*

In this case, result data are re-calculated excluding the data of the current interval when the measurement is stopped. This causes that "Count" and "Ratio" displayed after the measurement will be different from that of during measurement.

The sum of interval time (multiplied interval time by the number of back logs) may not match the differential time between displayed time at left top and right top after the measurement.

Selecting type of results

Open the middle drop-down menu in the top row of buttons to select which results you want to display on the screen.

- **Reflector**
- **Link**
- **Frame**
- **Performance**
- **Size Distribution**

Studying a specific result

Touch a specific cell in a result table to zoom in on the corresponding result item. The **Count** and **Ratio** fields are displayed on a **Zoom** tab page. A **Histogram** tab page is also available. Use the **Back** button to return to the statistics screen.

Selecting how results are displayed

Selecting notation

Select the required notation for the results from the notation drop-down menu.

- **Unformatted** - e.g. 71892
- **SI prefix** - e.g. 71.892 k (k means "kilo")
- **Engineering** - e.g. 71.892E3
- **Scientific** - e.g. 7.1892E4

10 Device Test Applications

This chapter describes the graphical user interface (i.e. screens, sub-screens and major dialogs) related to Device Test applications. Sub-screens and dialogs are described under the main screen from which they are activated/launched.

The following applications are available:

- [No Frame](#)

10.1 Device Test Setup and Status

10.1.1 Physical Port Setup

When the port is set up with an interface, touching the **Port** button in the navigation area will display the screen shown below.

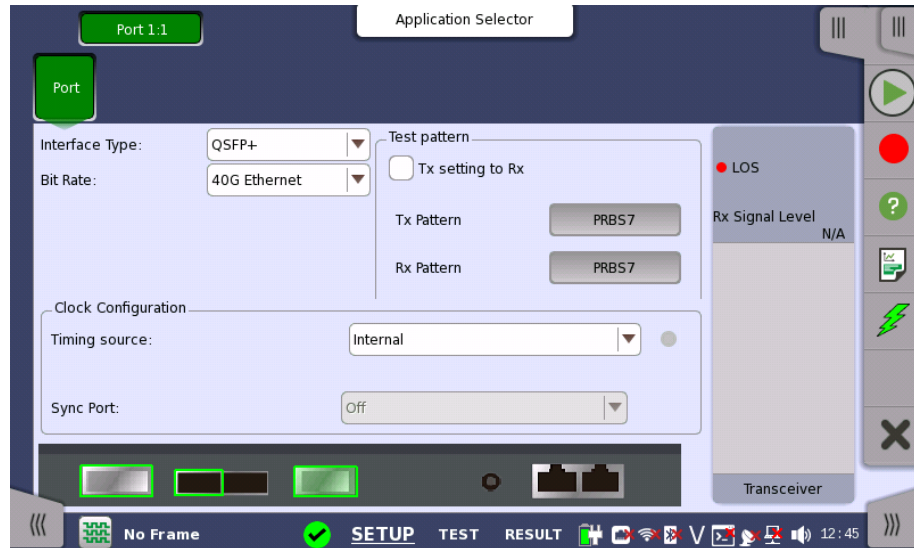

This screen allows you to specify the physical port configuration of the currently selected port. It can also be used to inspect the current status of the selected port.

The configuration options available in the setup area of the screen are described below. The status information is described in a separate section.

Interface Type

Select the interface of the module.

Bit Rate

Select the bit rate.

Lane Select

When bit rate is set to **100G Ethernet** or **OTU4**, select the number of lanes.

Test pattern

Touch the button to launch the dialog box for setting the test pattern. When selecting **Tx setting to Rx**, Rx pattern will be set to the same as Tx pattern.

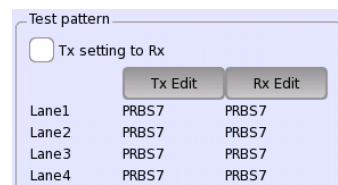

When Lane Select is set to **4 Lanes**, you can set patterns for each lane.

Clock Configuration

Timing source

The possible sources are:

- Internal
- External

When **External** is set, the right hand lamp indicates whether clock is detected or not.

Sync Port

This item appears when Interface Type is set to **CFP4**, **SFP28**, or **QSFP28**.

Selects the output of Sync Clock Output connector on MU100011A panel.

- **Off**: does not output the clock.
- **1/8**: outputs 1/8 divided clock of the 25/28 Gbps data synchronized clock.
- **1/16**: outputs 1/16 divided clock of the 25/28 Gbps data synchronized clock.

10.1.2 Status Information

This section describes the status information available for the Device Test Applications in the status area of the **Ports Setup** screen.

10.1.2.1 Status Summary

The status summary displayed for the Device Test Applications consists of the following information:

Physical Status

The topmost part of the status area gives you access to information about the current physical status of the selected interface. A summary consisting of the most relevant status indicators is displayed constantly. By touching the summary, you can launch a display that contains the detailed status information.

Monitor Status

At the bottom of the status area are below buttons that give you access to various monitor information. By touching a button, you can launch the corresponding information display.

- **Transceiver**

10.1.2.2 Physical Details

Touching the topmost summary box in the status area of the **Ports Setup** screen launches the status shown below.

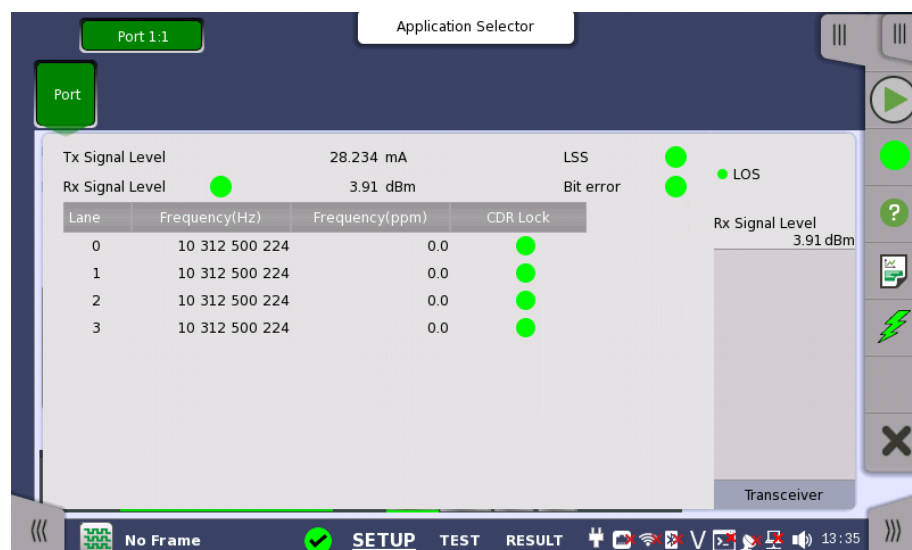

This screen presents detailed information about the current physical status of the received signal at the Device Test interface.

The physical status information consists of the following parameters:

Tx Signal Level

Shows the output level of an optical signal.

Rx Signal Level

Shows the input level of an optical signal. A lamp icon indicates the LOS state.

LSS

The currently Link Status Signal is shown by the icon.

- *Red* means that the link is not established.
- *Green* means that the link is established.

Bit error

The bit error status is indicated by the use of [colored Lamp icons](#).

Frequency

Shows the input signal frequency and the deviation of the input signal from the nominal bit rate in ppm. In case of multi lanes, the frequencies and deviations are displayed by each lane.

CDR Lock

The clock data recovery status is shown by the icon.

- *Red* means that the timing clock cannot be recovered from received data.
- *Green* means that the timing clock is ok.

10.1.2.3 Transceiver

Refer to [Transceiver](#) in "Ethernet Setup and Status" section.

10.1.3 Errors/Alarms Insertion

This section describes the errors or alarms insertion for the Device Test on the [Application toolbar](#).

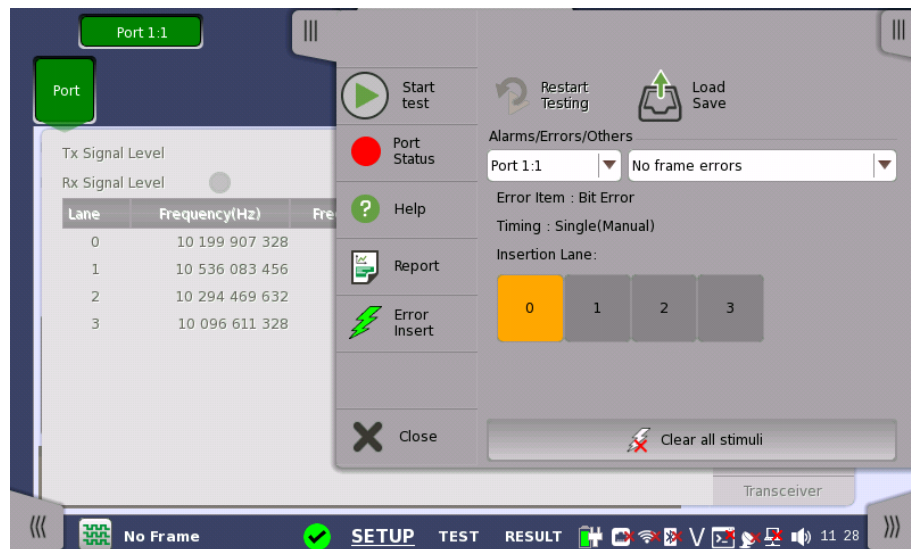

Alarms/Errors/ Others

Select the port to insert errors, and the stimuli type. Depending on the stimuli type, the setting items will appear.

- **No frame errors:** Inserts bit errors to specified lanes.
- **No frame frequency:** Adds the frequency offset to the selected bit rate.

10.1.3.1 No frame errors

1. Touch the buttons of **Insertion Lane**, the dialog box will appear.
2. Touch the buttons to select/clear lanes. The errors will be inserted to selected (orange) lanes.
3. Touch the **Error Insert** icon. The errors will be inserted once by touching the icon.

10.1.3.2 No frame frequency

Touch the field to set **Frequency Offset**. If setting a positive value, the frequency will shift higher side.

Example:

If setting 10 ppm to the frequency offset when Bit Rate is set to OTU3, the bit rate of output signal will be

$$43\,018\,413.559 * (1+10*10^{-6}) = 43\,018\,843.73 \text{ (kbit/s).}$$

10.2 No Frame Test



No Frame Test is the test which uses the pattern without frame structure. No Frame Test measures the BER (bit error rate) and the frequency.

10.2.1 Ports Setup and Status

The first step in running an application is to set up the port interfaces. This is done on the **Ports Setup** screen, which also provides port status information.

The setup options and status information related to the Ethernet interface are described in a separate section:

- [Device Test Setup and Status](#)

10.2.2 Test Setup

10.2.2.1 Control

When you go to the test setup of the No Frame application, the following screen is displayed.

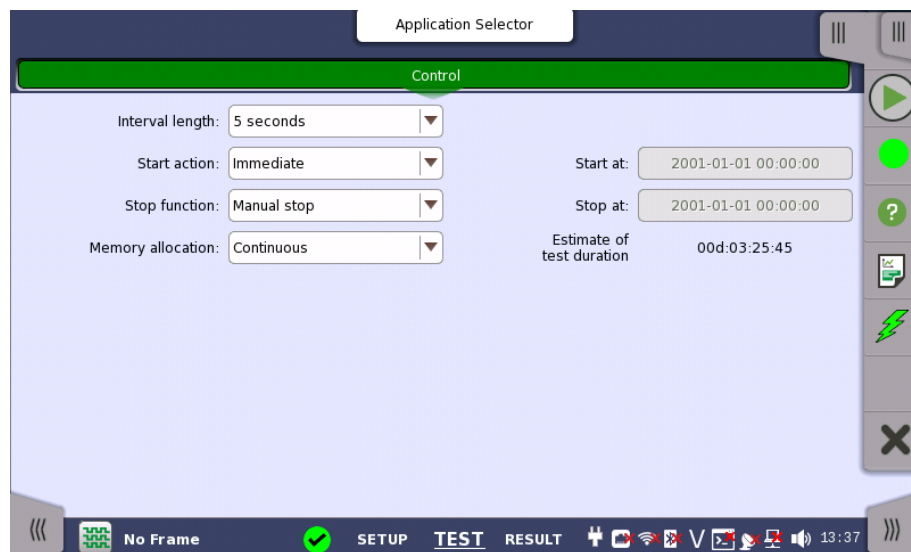

This screen contains the parameters that are generally required in a No Frame test setup.

Interval length

Allows you to specify the duration of the intervals. The drop-down menu contains the following values: 1, 2, 5, 10, 15, 30 seconds, 1, 5, 10, 15, 30 min., 1, 2, 4, 6, 12 hours or No Intervals.

Start action

Allows you to specify when the measurement is started.

- If **Immediate** is selected, the measurement starts when you touch the **Start** button.
- Selecting **Start at** will enable a delayed start. The start time for a delayed start can be specified in the adjacent **Start at** field.

Stop function

Allows you to specify when the measurement ends. Select the relevant option from the drop-down menu:

- If **Manual stop** is selected, the measurement will stop immediately when the **Stop** button is touched.
- Selecting **Stop at** will enable the adjacent field, in which you can specify the stop time.
- Selecting **Duration** will allow you to specify a duration time in the adjacent field.

Memory allocation

Allows you to specify how the measurement will be stored in the Network Master's memory. Select the relevant option from the drop-down menu:

- **Use all storage**: When Network Master's memory became full with measured data, the whole measurement is stopped.
- **Continuous**: When Network Master's memory became full with measured data, the oldest records in that memory will be overwritten.

The Network Master's memory size (the file size of measurement results) is 64 Mbytes per one port.

Estimate of test duration

Contains an estimation of the time (in days, hours, minutes and seconds) before the whole memory will be filled out by the test. During an ongoing measurement, the estimate will be recalculated periodically.

10.2.3 Test Results

10.2.3.1 Statistics

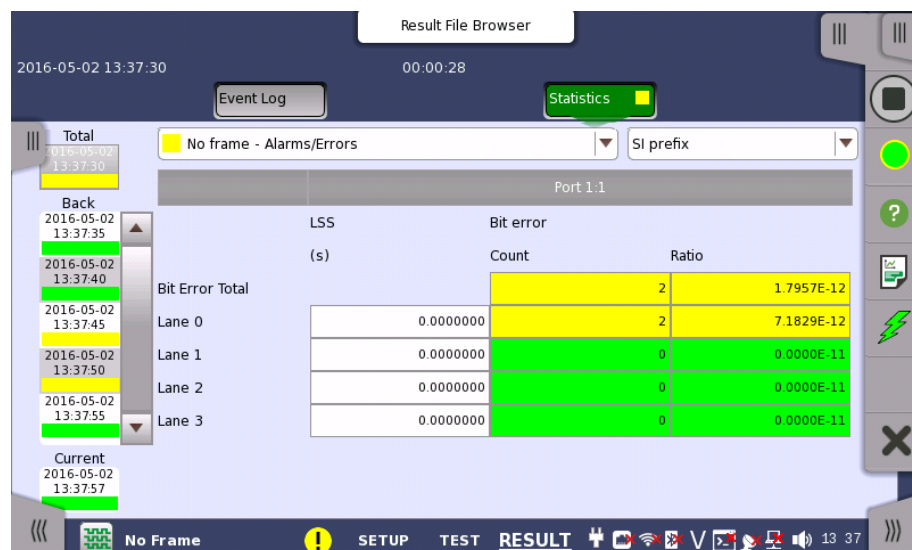

This screen presents a detailed analysis of the test results. You can choose to view either the results of a specific time interval or the total results from measurement start. The results can be displayed either in table (list) form or as graphs. You can also zoom in on a specific result item and display either a zoom or a histogram.

Selecting which results to view

Selecting the interval time

Touch the **Total** button to switch the total values measured in all interval times. The start time of measurement is displayed on the button.

Touching the button in left side **Back** field shows the measured values in the interval time. The end time of the interval is displayed on the button.

The **Current** button is displayed at left bottom when the measurement is running. Touching the **Current** button shows the measured values in the current interval time. The start time of the current interval is displayed on the button.

The slide-out panel on the left-hand side of the screen contains the following functions:

- Only show intervals that contains errors
- Time format

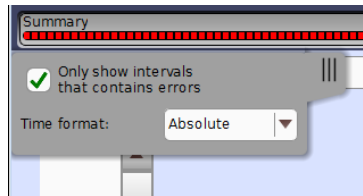

*If you have stopped measurement during the interval time, the measurement results of the current interval are discarded. The log of the current interval is not displayed in **Back** field.*

In this case, result data are re-calculated excluding the data of the current interval when the measurement is stopped. This causes that "Count" and "Ratio" displayed after the measurement will be different from that of during measurement.

The sum of interval time (multiplied interval time by the number of back logs) may not match the differential time between displayed time at left top and right top after the measurement.

Selecting type of results

Open the middle drop-down menu in the top row of buttons to select which results you want to display on the screen.

- [No frame - Alarm/Errors](#)
- [No frame - Frequency](#)

Studying a specific result

Touch a specific cell in a result table to zoom in on the corresponding result item. The **Count** and **Ratio** fields are displayed on a **Zoom** tab page. A **Time vs. Statistics** tab page is also available. Use the **Back** button or touch the zoom filed to return to the statistics screen.

Selecting how results are displayed

Selecting notation

Select the required notation for the results from the notation drop-down menu.

- **Unformatted** - e.g. 71892
- **SI prefix** - e.g. 71.891 k (k means "kilo")
- **Engineering** - e.g. 71.892E3
- **Scientific** - e.g. 7.1892E4

Results

Results are displayed according to your choice.

No frame - Bit error
Alarms/Errors
No frame - Frequency Rx Frequency

11 Utility Applications

This chapter describes the applications on the Utilities screen of Application Selector.

The following applications are available:

- [Scenario](#)
- [GPS](#)
- [PDF Viewer](#)
- [VIP](#)
- [Wireshark](#)

11.1 Scenario

Scenario application executes applications according to the description in the scenario file. The contents of the scenario file can be edited by using the *MX100003A MT1000A/MT1100A Scenario Editor Software* on the PC.

If the scenario files are not loaded, only Scenario manager icon appears on the [Utilities](#) screen.

If the scenario file has loaded, that icon is displayed on the Utilities screen. The icon of the scenario varies depending on the definition in the scenario.



An example of the scenario icons

Displaying / hiding of the icon can be switched by the Scenario manager screen setting.

11.1.1 Scenario Manager



When you go to the test setup of the Scenario Manager, the following screen is displayed.

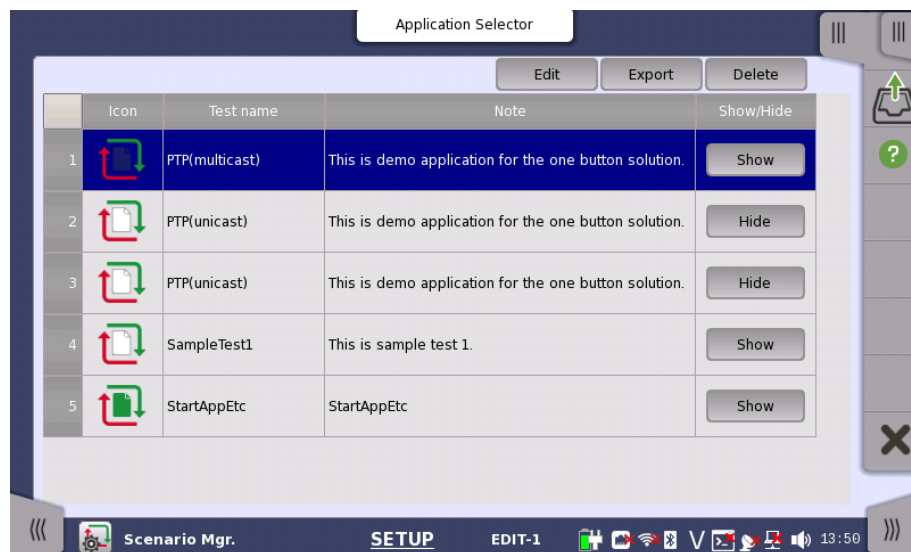

This screen provides following operations:

- Loading a scenario file
- Switching displaying the icon of the scenario or not
- Saving the scenario to file
- Deleting the scenario in the table

Loading a scenario file

1. Touch the on [Application Toolbar](#).
2. Select the file using the dialog box.
3. Touch **Open**.
4. The contents of the loaded scenario appear in the table. Icon, Test name and

Note are defined in the scenario. They cannot be edited on the Scenario Manager screen.

Editing the scenario

1. Touch the row of the scenario in the table.
2. Touch **Edit** button. The Edit screen appears.
3. Touching the **Value** field opens the dialog box.

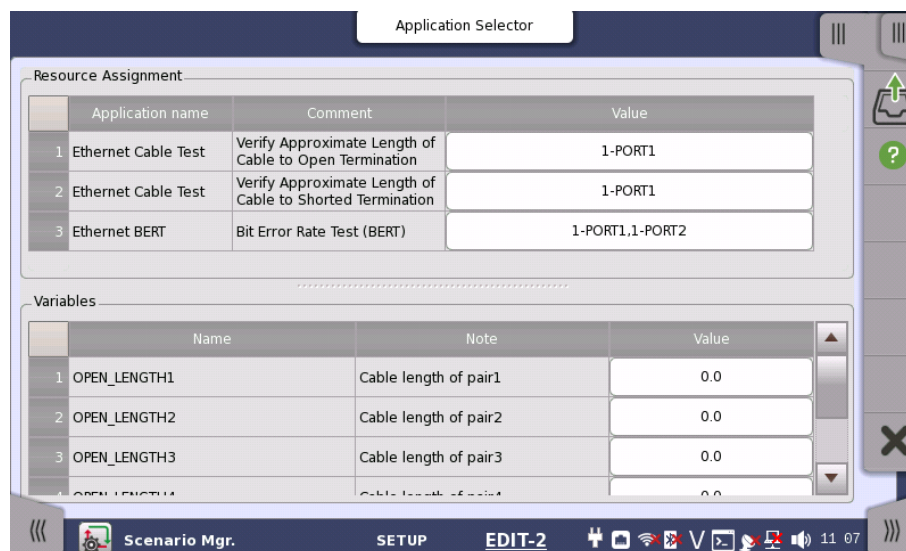

Touch the **SETUP** at the bottom of the screen to return to the setup screen.

The warning icon appears at right of Resource Assignment when the port defined in the scenario does not exist. In this case, touch the **Value** field and set the available port(s).

Exporting the scenario to the file

Allows user to save the edited scenario.

1. Touch the row of the scenario in the table.
2. Touch **Export** button. The dialog box appears.
3. Enter the file name, then touch **Save**.

Deleting the scenario

This operation deletes the scenario in the table.

1. Touch the row of the scenario in the table.
2. Touch **Delete** button.
3. The confirmation dialog box appears. Touch **Yes**.

Hiding/showing the scenario icon

Touch **Hide** button to switch showing or hiding the scenario icon.

Hide: Does not show the scenario icon on the Utilities screen (Displayed currently).

Show: Shows the scenario icon on the Utilities screen (Not displayed currently).

11.1.2 Running the Scenario

When scenario is loaded, the icon appears in Scenario of the Utilities screen. If touching the icon, the following screen is displayed.

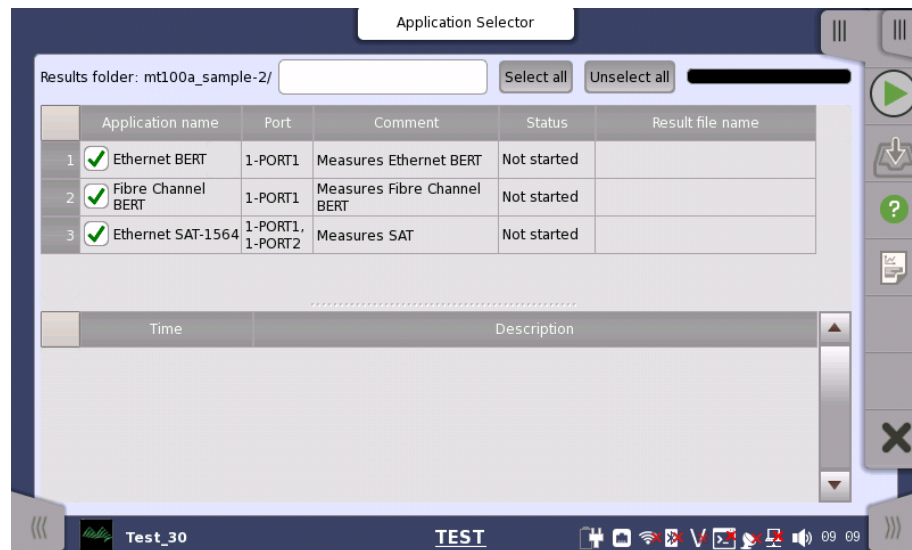

This screen displays the Pass/Fail results and status of the scenario execution. Select the check box for the application name you want to run.

To run the scenario, touch  in the Application Toolbar.

Results folder

The destination folder to save the result file is displayed. Touch the field to open the dialog box and select the folder. If selecting **Auto**, the folder name will be generated automatically.

The button to specify the destination drive appears when touching an icon on the Utilities screen after USB memory stick was connected to the Network Master.



Even if **Result Folder :Usb** has been set, result files are stored in Internal memory temporary and moved to USB memory stick after the scenario execution has finished.

In cases below, a warning message appears when Network Master attempts to save result files to USB memory stick. If Network Master failed to save result files to USB memory stick, they are stored in Internal memory.

- The USB memory stick was removed.
- The free space of the USB memory stick is insufficient.

Application and the result display

In the upper table, Application name, Port number for test use, and comment which are written in the scenario are displayed. If the scenario has executed, the test result and the result file name appear in the each column.

Status indication during Scenario execution

In the lower table, the status of the application and the time that has occurred are displayed.

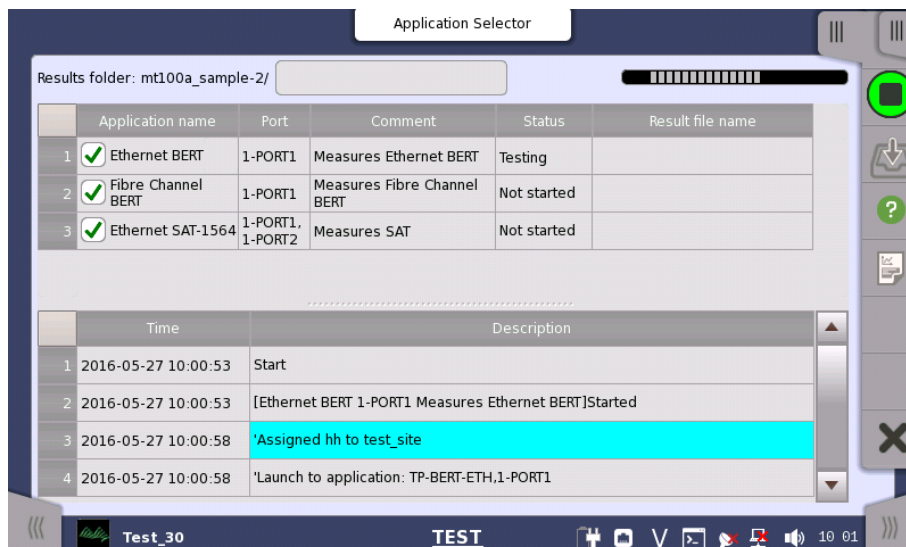

An example of the scenario execution

Save results

1. Touch the  on [Application Toolbar](#)
2. Set the file name using the dialog box displayed.
3. Touch **Save** button.

Generating the report

1. Touch the  on Application Toolbar
2. Setup Report Generator using the dialog box. For details, refer to "Report" in [Application Toolbar](#).
3. Touch **Generate** button.

11.2 GPS



GPS application logs NMEA format data received from the GPS receiver. According to the NMEA format data, the locations of satellite are displayed on the chart.

11.2.1 Test Setup

When you go to the test setup of the GPS application, the following screen is displayed.

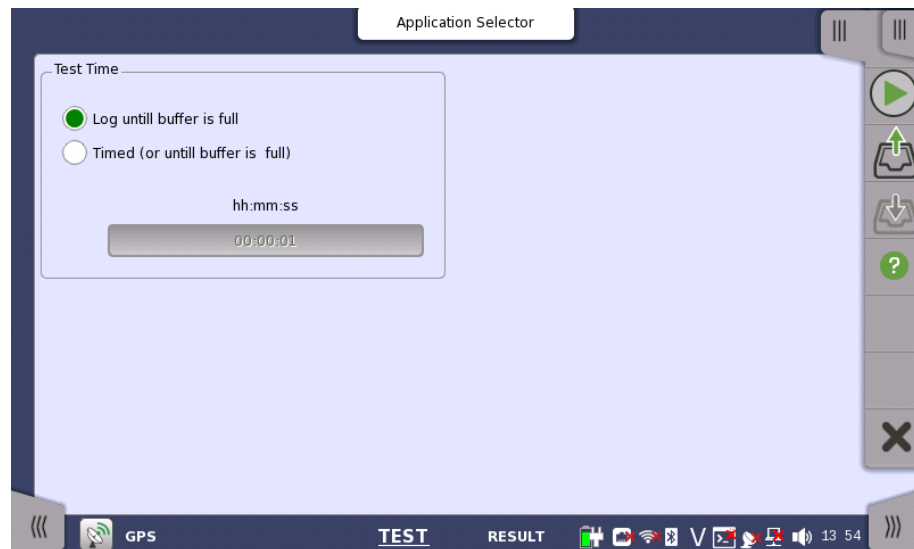

Test Time

Select the how to stop the test.

- **Log until buffer is full:** The test stops when the buffer memory is full with the log data. It takes around 13 hours to fill the buffer.
- **Timed (or until buffer is full):** The test stops when the specified time has elapsed or when the buffer memory has become full.

Days, Hours, Minutes

Touch the field to set the test time.

11.2.2 Test Results

When you go to the test result of the GPS application, the following screen is displayed.

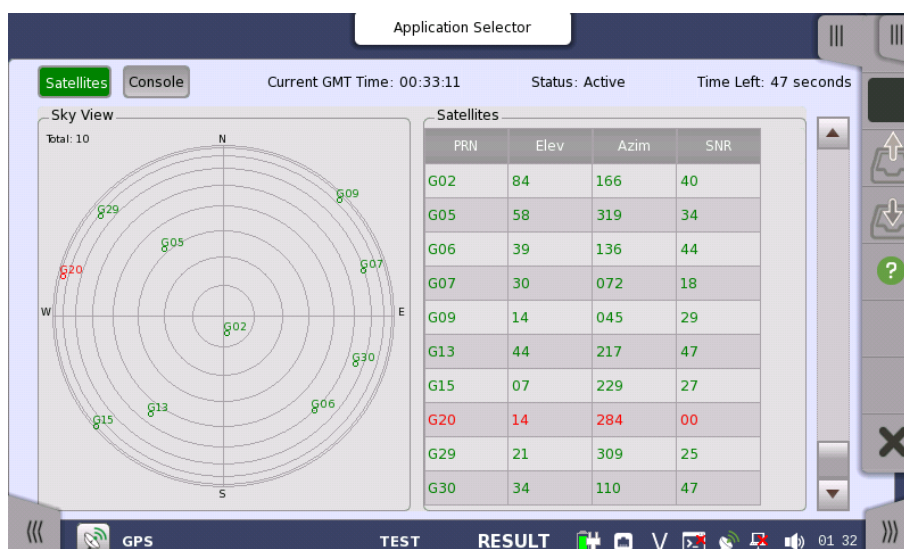

This screen displays positions of satellite and the logged data. Touch a left top button to switch the result to display.

- **Satellites:** Displays the satellite positions by the chart and the table.
- **Console:** Displays the logged data received from GPS receiver.

Touch  to start a test.

Current Time

The time received from GPS appears.

Status

- Active: Data have been received from GPS receiver.
- Stopped: Data reception from GPS receiver has stopped.

Time Left

When **Timed** is selected on the Test setup screen, the remaining test time is displayed.

Satellites

Sky View

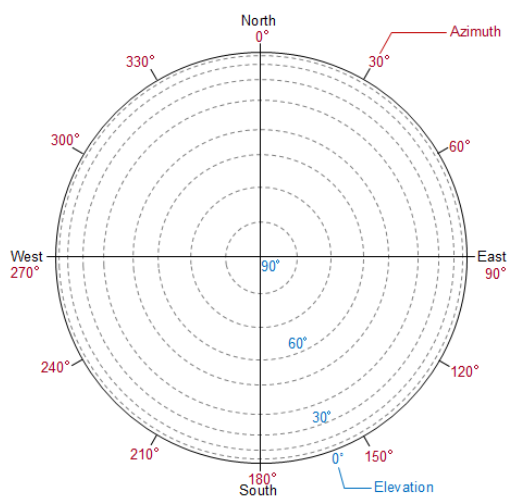

Radius of the circle corresponds to the elevation. The position at circle edge is where the elevation is 0 degree.

Clockwise angle corresponds to the azimuth. Top of the circle corresponds to north.

Satellites

Data of the received satellites are displayed.

- PRN: Displays the satellite number. (Pseudo-Random Noise sequences)

- Elev: Elevation
- Azim: Azimuth
- SNR: Signal to Noise Ratio

Depending on the SNR value, the text color varies in green, blue, or red.

Console

Text Console

The logged data in text data are displayed. You can save the logged data by touching  icon on the Application Toolbar.

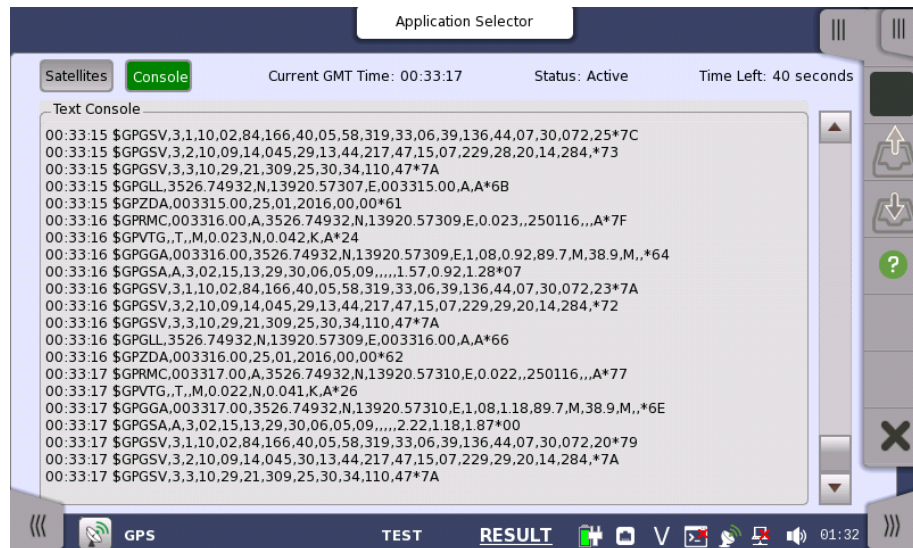

The log data format follows NMEA 0183 rev4.0 that is widely used in the GPS technology.

11.3 PDF Viewer



PDF Viewer allows you to view PDF files, for example, Operation Manual, report files created by the Network Master, etc.

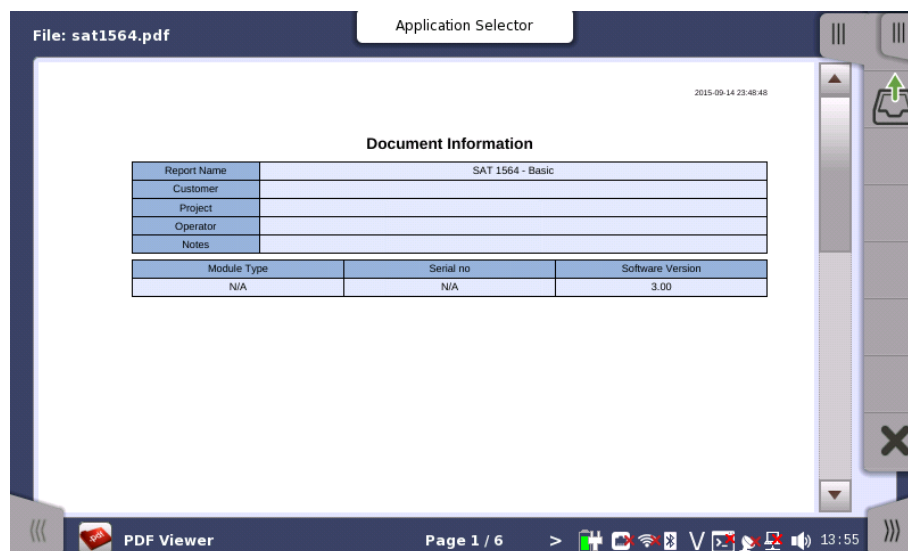

Opening the PDF file

Touching the File Open icon () on Application Toolbar opens the dialog box, where you can select a PDF file you want to open.

Scrolling the window

The page number is displayed at bottom center of the screen. Touching < or > next to the page number allows you to move the page. Right hand scroll bar allows you to scroll the view vertically.



The following functions are not supported.

- *Zoom in and out*
- *Link*
- *Search*
- *Bookmarks*

11.4 VIP



VIP (Video Inspection Probe) application allows you to view the edge surface of an optical fiber by using the optional accessory Video Inspection Probe. The captured image and analysis results can be saved to files.

11.4.1 Application Toolbar

Icons for VIP use appear on Application Toolbar.

Capture



Touch the **Capture** icon to capture the current displaying image. When **Auto Focus** is selected in Setup screen, touching this icon performs autofocus and capturing the image.

Press for Live image



Touch the **Press for Live image** icon to display the live image on the screen.

Analyze Image



Touch the **Analyze Image** icon to start analyzing the captured image.

Save



Touch the **Save** icon to save the image and analysis results to files.

Load



Touch the **Load** icon to load a following file.

- Image file (*.png)
- Analysis result file (*.vipi)

Only **Load Save** icon appears on the Expanded Application toolbar. The VIP images and analysis results can be loaded by touching the icon.



The analysis result file (extension vipi) is compatible with following models.

- MT9083 Series Access Master
- MU909014x, MU909015x μ OTDR Module

11.4.2 Connecting the Video Inspection Probe

Connect the USB connector of the Video Inspection Probe to Network Master.



G0382A Autofocus Video Inspection Probe

Replace the adaptor of the Video Inspection Probe with one that matches the optical connector.

For handling the Video Inspection Probe, refer to the operation manual that came with the Video Inspection Probe.

G0382A goes into the standby state unless the operation is performed for 60 seconds. If it enters the standby state, press the measurement button (M) on G0382A or touch the  icon on the Network Master before using it.

Network Master also supports following the Video Inspection Probes.

- OPTION-545VIP USB 200/400x Video Inspect Probe
- G0293A Video Inspection Probe Lite
- G0306A Video Inspection Probe
- G0306B Video Inspection Probe



At the lower left area of the screen, this icon indicates the connection status of the Video Inspection Probe.

11.4.3 Test Setup

When you go to the test setup of the VIP application, the following screen is displayed.

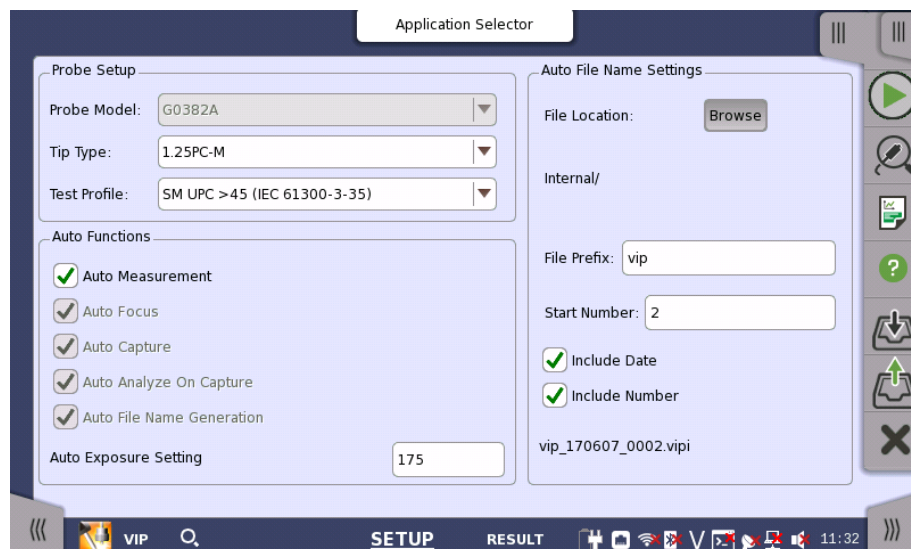

This screen allows you to configure the parameters related to a VIP test.

Probe Setup

Probe Model

When G0306A, G0306B, or G0382A is connected to Network Master, the model is displayed. Otherwise, select the model of the Video Inspection Probe.

Tip Type

Select the tip type to use.

Test Profile

Select the observing fiber type. Limits which will be judged as "Pass" are shown in tables.

In the following tables, "None" means that the fiber has no scratches or defects. "No limit" means that there is no limit to the number of scratches or defects. For example, "None >3 μ m" the fiber has no scratches or defects which is larger than 3 μ m.

- **SM PC>45:** Single Mode Fiber, Physical Contact, Return Loss is more than 45 dB.

Zone Name	Defects	Scratches
Core	None	None
Cladding	No limit <2 μ m 5 from 2 μ m to 5 μ m None >5 μ m	No limit ≤3 μ m None >3 μ m
Adhesive	No limit	No limit
Contact	None ≥10 μ m	No limit

- **SM APC:** Single Mode Fiber, Angled Physical Contact

Zone Name	Defects	Scratches
Core	None	≤4
Cladding	No limit <2 μ m 5 from 2 μ m to 5 μ m None >5 μ m	No limit
Adhesive	No limit	No limit
Contact	None ≥10 μ m	No limit

- **SM PC>25:** Single Mode Fiber, Physical Contact, Return Loss is more than 25 dB.

Zone Name	Defects	Scratches
Core	2 ≤3 μ m None >3 μ m	2 ≤3 μ m None >3 μ m
Cladding	No limit ≤2 μ m 5 from 2 μ m to 5 μ m None >5 μ m	No limit ≤3 μ m 3 >3 μ m
Adhesive	No limit	No limit
Contact	None ≥10 μ m	No limit

- **MM PC 62.5:** Multi-Mode Fiber, Physical Contact, Core diameter 62.5 μ m

Zone Name	Defects	Scratches
Core	4 ≤5 μ m None >5 μ m	No limit ≤3 μ m 0 >5 μ m
Cladding	No limit ≤2 μ m 5 from ≤2 μ m to ≤5 μ m None >5 μ m	No limit ≤5 μ m 0 >5 μ m
Adhesive	No limit	No limit
Contact	None ≥10 μ m	No limit

- **MM PC 50.0:** Multi-Mode Fiber, Physical Contact, Core diameter 50 μ m

Limits are the same as **MM PC 62.5**.

Auto Functions

Auto Measurement

When it is recognized that the fiber edge surface is in the image, Auto Focus, Auto Capture, Auto Analyze On Capture, and saving a file are performed automatically.

Auto Measurement is available for G0306A, G0306B, and G0382A.

Auto Focus

When it is recognized that the fiber edge surface is in the image, autofocus and capture are performed.



If it cannot be recognized that the fiber edge surface is in the image, VIP may not perform autofocus. In that case, get a focus using < or > button on G0382A.

Auto Focus is available for G0382A.

Auto Capture

When it is recognized that the fiber edge surface is in focus, the image is captured automatically.

Auto Capture is available for G0306A, G0306B, and G0382A.

Auto Analyze On Capture

Executes Auto Analyze when the image has been captured.

Auto File Name Generation

File name is generated automatically when saving the file. Selecting the check box activates **Auto File Name Settings**.

Auto Exposure Setting

The value can be set when **Auto Measurement** is selected. Set target value of auto exposure in the range of 160 to 190.

Auto File Name Settings

File Location

Touch the **Browse** button to select a folder to save files.

File Prefix

Touch the field and set the string used in the file name. Touching **Quick Matrix** at bottom of **File Prefix Edit** dialog box opens **Input Text** dialog box to register string.

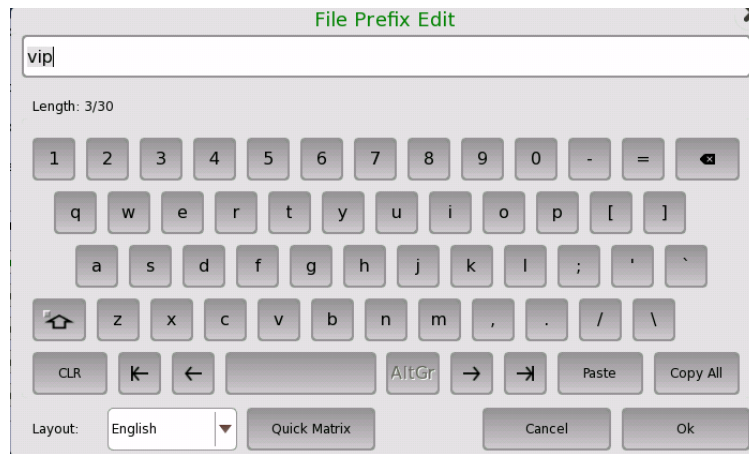

To register string, touch a blank button. Touching labeled button adds the string to file name.

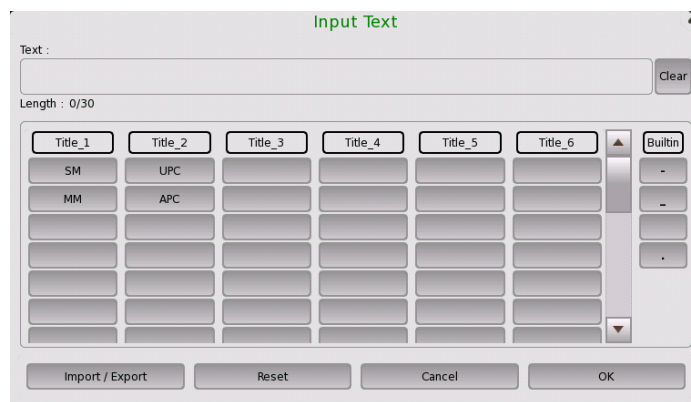

- **Import/Export:** Saves string on buttons to a file or loads string from a file.
- **Reset:** Erases string on all buttons.
- **Cancel:** Discards edited string and closes dialog box.
- **OK:** Applies edited string and closes dialog box.

Start Number

Touch the field and set the start number of value used in the file name.

Include Date

If selecting the check box, date will be appended in the file name.

Include Number

If selecting the check box, a file number will be appended in the file name.

The file name to be generated first is displayed under this item.

11.4.4 Test Results

When you go to the test results of the VIP application, the following screen is displayed.

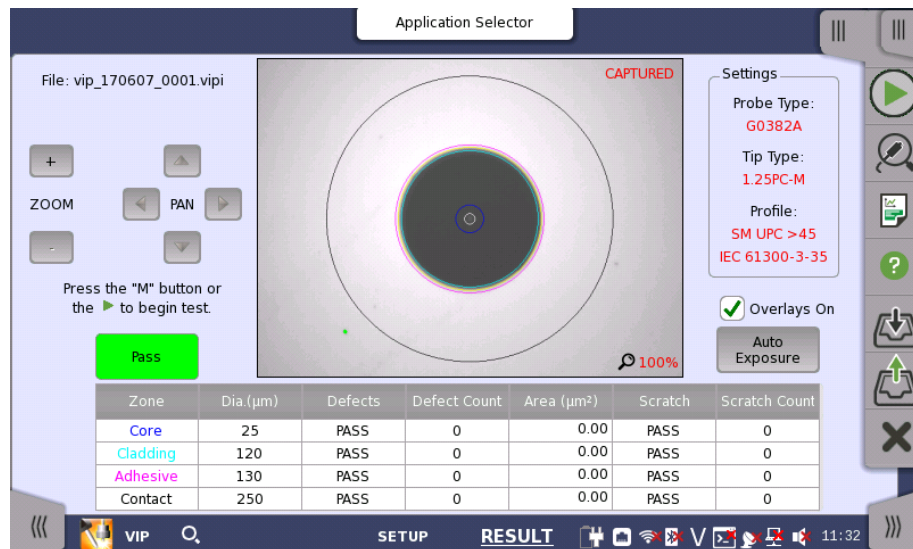

This screen displays the image captured by the Video Inspection Probe. Analyzing an image of the fiber edge surface is also available.

Analyzing an image

When **Auto Capture** is not selected, follow the procedure below:

1. Touch .
2. Touch .

After the analysis finishes normally, the results appear in the table.

If **Overlays On** is selected, the circles showing the analysis area appear.

3. Adjust image position by touching **Zoom** buttons or **PAN** buttons.



When using G0382A, pressing the M button on VIP starts capturing and analyzing an image.

The items in tables are:

- [Zone]: Name of the analysis area
- [Dia. (μm)]: Measurement result of the diameter
- [Defects]: Judgement result of defects
- [Defect Count]: Number of measured defects
- [Area (μm²)]: Total area of the detected defects
- [Scratch]: Judgement result of scratches
- [Scratch Count]: Number of measured scratches

Overlays On

If selecting the check box, the circles showing the analysis area appear.

Auto Exposure

This button appears when Probe Model is **G0382A**.

Touching the button maintains the image brightness at appropriate level by adjusting exposure.

11.5 Wireshark



Wireshark allows users to analyze captured Ethernet frames.



Wireshark is used to analyze the capture files. There are some restrictions on functions because Ethernet interface is not connected. For example, "Capture" and "Telephony" menus are not available.

When Wireshark is started, the following screen appears.

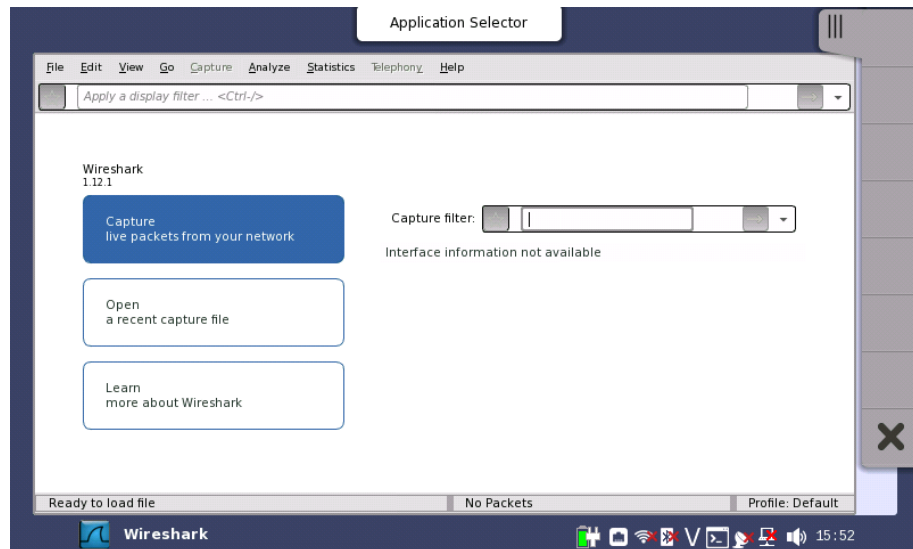

To open a file, touch the "File" menu, and then touch "Open".

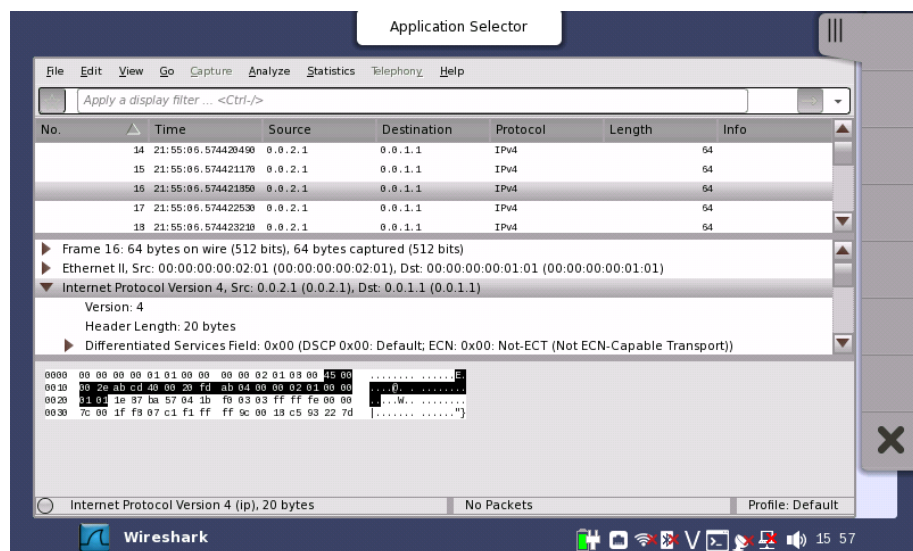

To analyze eCPRI packets and IEEE 1914.3 packets on PC

To analyze eCPRI packets and IEEE 1914.3 packets using Wireshark installed in PC, copy lua files to PC following the procedure below.

1. Connect USB memory stick to the Network Master.
2. Touch File Manager (🏠) on Instrument toolbar.
3. Open /Internal/windowsinstaller/wireshark folder.

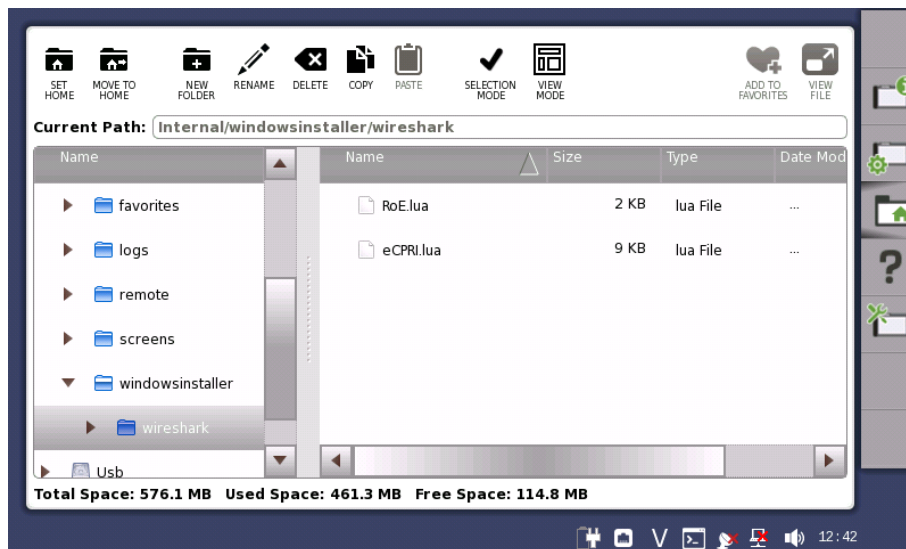

4. Copy RoE.lua and eCPRI.lua to USB memory stick.
5. Remove USB memory stick from the Network Master and connect it to PC.
6. Copy RoE.lua and eCPRI.lua to the following folder.
C:¥Program Files¥Wireshark¥plugins¥(Version number)
Example: C:¥Program Files¥Wireshark¥plugins¥2.4.4

12 Specifications

12.1 MT1000A

This section contains specifications for the Network Master Pro, MT1000A (mainframe).

12.1.1 Configuration

	- Main Frame -
MT1000A	Network Master Pro
	- Standard Accessories -
	Power Cord * ¹
G0310A	LiION Battery
G0385A	High Power AC Adapter
B0728A	Rear Panel Kit
B0745A	Softcase
Z1746A	Stylus
Z1747A	Carrying Strap
Z1748A	Handle
Z1817A	Utilities ROM * ²
W3935AE	MT1000A Transport Modules Quick Reference Guide

*1: Power cord come with according to a shipping destination.

*2: Following manuals are stored:

- W3933AE MT1000A Transport Modules Operation Manual
- W3736AE MT1000A Network Master Pro MT1100A Network Master Flex Remote Scripting Operation Manual
- W3810AE MT1000A Network Master Pro OTDR Modules Operation Manual
- W3859AE MT1000A Network Master Pro OTDR Modules Remote Scripting Operation Manual
- 10580-00443 MT1000A MU100040A/MU100040B Network Master Pro Operation Manual

	- Options -
MT1000A-003	Connectivity for WLAN/Bluetooth
MT1000A-005	AUX I/O
MT1000A-006	High Power Supply
MT1000A-ES210	2 Years Extended Warranty Service
MT1000A-ES310	3 Years Extended Warranty Service
MT1000A-ES510	5 Years Extended Warranty Service

*: Necessary when using MU100011A.

- Optional Accessories -

B0691B	Hard case
B0720A	Rear Cover
B0729A	Screw 1U
B0730A	Screw 2U
B0731A	Screw 3U
B0732A	Screw Kit
B0733A	Hard Case
G0306B	Video Inspection Probe
G0324A	Battery Charger
G0325A	GPS receiver
G0382A	Autofocus Video Inspection Probe
J1569B	Car 12 Vdc adapter
W3933AE	MT1000A Transport Modules Operation Manual

- Modules -

MU100010A	10G Multirate Module
MU100011A	100G Multirate Module
MU100020A	OTDR Module 1310/1550nm SMF
MU100021A	OTDR Module 1310/1550/850/1300nm SMF/MMF
MU100022A	OTDR Module 1310/1550/1625nm SMF
MU100040A	CPRI RF Module
MU100040B	CPRI RF Module with BBU Emulation Capability
MU100090A	High Performance GPS Disciplined Oscillator

12.1.2 External Interfaces

Internal Clock	Accuracy ± 4.6 ppm or less, STRATUM 3 compliant
Ref Clock Input	BITS (DS1 1.544 Mbit/s), SETS (E1 2.048 Mbit/s), 2MHz Clock, 10MHz Clock ITU-T G.703 compliant
	Connector BNC Jack
	Range ± 100 ppm
Service interface	USB (A x 2, mini B x 1 Port, Revision 2.0) RJ45 Ethernet (10/100/1000 BASE-T) WLAN (2.4GHz IEEE802.11b/g/n) Bluetooth (BT2.1+EDR) 3.5mm Audio Jack AUX Connector (for connection of optional G0325A GPS receiver)
AUX I/O	When AUX I/O option is set, the interface is available by combining with J1705A AUX Conversion Adaptor. J1705A AUX Conversion Adaptor is a standard accessory of the MU100090A.
	Ref 1PPS Input TTL 50 Ω /DC
	1PPS Input TTL 50 Ω /DC
Remote Control	Ethernet, GPIB (USB-GPIB)

12.1.3 Other Interfaces

Input device	Power switch, Touch panel
---------------------	---------------------------

LCD	9 inch display with WVGA resolution (800x480 pixels).
LED	On, Standby, Charge
Speaker	Built-in monaural speaker
Storage Memory	Without MT1000A-x06: 1 GB With MT1000A-x06: 7 GB

12.1.4 Environment Performance

Voltage	DC 18 V AC 100 V to 240 V, 50/60 Hz Without MT1000A-x06: 3.62 A Max. (with dedicated G0309A AC adaptor) With MT1000A-x06: 6.6 A Max. (with dedicated G0385A AC adaptor)
Power consumption	Battery Dedicated 10.8 V Rechargeable smart Li-ion battery Without MT1000A-x06: 65 W max. With MT1000A-x06: 120 W max.

Battery Charging Time 3 to 6 hours (at 25°C, typical)

Temperature range	Operating: 0°C to +50°C, ≤85%RH (non-condensing)* Charging battery: 0°C to +40°C, ≤85%RH (non-condensing) Storage: -30°C to +60°C, ≤90%RH (Excluding battery and AC adapter) -20°C to +50°C, ≤90%RH (Including battery and AC adapter) (non-condensing)
--------------------------	---

*: The maximum allowed charging temperature will be reduced if the instrument is switched on.

EMC EN61326-1 and EN61000-3-2.

LVD EN61010-1.

Wireless Certification For countries and regions permitting WLAN use, refer to the following URL.
<https://www.anritsu.com/ja-JP/test-measurement/support/downloads/brochures-datasheets-and-catalogs/dwl16689>

12.1.5 Mechanical Performance

Size	163(H) x 257.6 (W) x 43.5(D) (Excluding projections)
Mass	1.6 kg max.

12.2 MU100010A 10G Multirate Module

In the following you find specifications for the Network Master Pro MU100010A module. The MU100010A specification lists the functionality added to the basic Network Master Pro by installing the MU100010A option. Refer to the [MT1000A](#) section for further information about the Network Master Pro's basic functionality.

12.2.1 Configuration

	- Module -
MU100010A	10G Multirate Module
	- Standard Accessories -
B0692A	ESD box*
*: Up to four SFP+/SFPs can be stored.	
	- Options -
MU100010A-ES210	2 Years Extended Warranty Service
MU100010A-ES310	3 Years Extended Warranty Service
MU100010A-ES510	5 Years Extended Warranty Service
	- Basic Option (Software) -
MU100010A-x01	Up to 2.7G Dual Channel
	- Protocol Option (Software) -
Ethernet:	
MU100010A-x11	Ethernet 10G Single Channel
MU100010A-x12	Ethernet 10G Dual Channel
MU100010A-x20	TCP Throughput
OTN:	
MU100010A-x51	OTN 10G Single Channel
MU100010A-x52	OTN 10G Dual Channel
MU100010A-x61	ODU Multiplexing
MU100010A-x62	ODU Flex
CPRI/OBSAI:	
MU100010A-x71	CPRI/OBSAI Up to 5G Dual Channel
MU100010A-x72	CPRI/OBSAI 6G to 10G Single Channel
MU100010A-x73	CPRI/OBSAI 6G to 10G Dual Channel
SDH/SONET:	
MU100010A-x81	STM-64 OC-192 Single Channel
MU100010A-x82	STM-64 OC-192 Dual Channel
Fibre Channel:	
MU100010A-x02	FC 1G 2G 4G Dual Channel
MU100010A-x91	FC 8G 10G Single Channel
MU100010A-x92	FC 8G 10G Dual Channel

12.2.2 External Interfaces

Test signal interface	SFP/SFP+:	2 Slots SFF-8431, SFF-8472 compliant IEEE 802.3ae-2002, IEEE802.3-2008 compliant
	RJ45:	2 Sockets IEEE802.3-2008 10BASE-T, 100BASE-TX, 1000BASE-T compliant Auto MDI-X 10/100 Mbps Full/Half Duplex, 1000 Mbps Full Duplex
	RJ48:	2 Sockets ITU-T G.703 compliant
	RTT BANTAM:	4 ports ANSI DS1.102 compliant
	BNC:	4 ports ITU-T G.703 compliant
Simultaneous Measurement Port		2 ports

Bit Rate	Standard	Bit Rate	Interfaces
	10BASE-T:	12.5 Mbit/s	RJ-45
	100BASE-TX:	125 Mbit/s	RJ-45
	1000BASE-T:	1.25 Gbit/s	RJ-45
	100BASE-XX:	125 Mbit/s	SFP
	1000BASE-XX:	1.25 Gbit/s	SFP, SFP+
	10GBASE-XX:	10.3125 Gbit/s	SFP+
	STM-1/OC-3:	155.52 Mbit/s	SFP
	STM-4/OC-12:	622.082 Mbit/s	SFP
	STM-16/OC-48:	2488.32 Mbit/s	SFP
	STM-64/OC-192:	9953.28 Mbit/s	SFP+
	OTU1:	2.666057143 Gbit/s	SFP
	OTU2:	10.70922532 Gbit/s	SFP+
	OTU1e:	11.04910714 Gbit/s	SFP+
	OTU2e:	11.09572785 Gbit/s	SFP+
	OTU1f:	11.27008929 Gbit/s	SFP+
	OTU2f:	11.31764241 Gbit/s	SFP+
	10GFC:	10.51875 Gbit/s	SFP+
	8GFC:	8.5 Gbit/s	SFP+
	4GFC:	4.25 Gbit/s	SFP, SFP+
	2GFC:	2.125 Gbit/s	SFP, SFP+
	1GFC:	1.0625 Gbit/s	SFP

E1:	2.048 Mbit/s	RJ-48/BNC
E3:	34.368 Mbit/s	BNC
E4:	139.264 Mbit/s	BNC
DS1:	1.544 Mbit/s	RTT Bantam
DS3:	44.736 Mbit/s	BNC
STM-1e/STS-3:	155.52 Mbit/s	BNC
CPRI1:	614.4 Mbit/s	SFP
CPRI2:	1228.8 Mbit/s	SFP
CPRI3:	2457.6 Mbit/s	SFP, SFP+
CPRI4:	3072.0 Mbit/s	SFP, SFP+
CPRI5:	4915.2 Mbit/s	SFP+
CPRI6:	6144.0 Mbit/s	SFP+
CPRI7:	9830.4 Mbit/s	SFP+
CPRI8:	10137.6 Mbit/s	SFP+
OBSAI 1x:	768 Mbit/s	SFP
OBSAI 2x:	1536 Mbit/s	SFP, SFP+
OBSAI 4x:	3072 Mbit/s	SFP, SFP+
OBSAI 8x:	6144 Mbit/s	SFP+

Bit rate offset range of transmitter Relative to [Bit Rate](#):

PDH/DSn:	-125 to +125 ppm
SDH/SONET:	-50 to +50 ppm
OTN	-50 to +50 ppm
Ethernet:	-100 to +100 ppm
CPRI/OBSAI:	-100 to +100 ppm

Bit rate tolerance of receiver Relative to [Bit Rate](#):

PDH/DSn:	-150 to +150 ppm
SDH/SONET:	-100 to +100 ppm
OTN	-100 to +100 ppm
Ethernet:	-100 to +100 ppm
CPRI:	-100 to +100 ppm

Optical Output Bit Rate Refer to [Bit Rate](#).

Optical Input Bit Rate Refer to [Bit Rate](#).

Electrical Output	1.5M/2M Output	1.5M/2M balanced output	
	Bit Rate	Refer to Bit Rate .	
	Pulse mask	ITU-T G.703 compliant	
	Code/Interface	1.544 Mbits/s	AMI/B8ZS Bantam 100Ω
	(Balance)	2.048 Mbits/s	HDB3 or AMI RJ-48 120Ω
	2M to 139/45/156M Output		
	Bit Rate	Refer to Bit Rate .	
	Pulse mask	ITU-T G.703 compliant	
	Code/Interface	2.048 Mbits/s	HDB3, BNC 75 Ω
	(Unbalance)	34.368 Mbit/s	HDB3, BNC 75 Ω
		44.736 Mbit/s	B3ZS, BNC 75 Ω
		139.264 Mbit/s	CMI, BNC 75 Ω
		155.520 Mbit/s	CMI, BNC 75 Ω
	Return Loss (Unbalance)	ITU-T G.703 compliant	
	10/100 /1000M Output		
Bit Rate	Refer to Bit Rate .		
	RJ-45		
Code/Interface	IEEE802.3-2008 10BASE-T, 100BASE-TX, 1000BASE-T compliant		

Electrical Input	1.5M/2M Input		
	Code/Interface	1.544 Mbits/s	AMI/B8ZS, Bantam 100 Ω
	(Balance)	2.048 Mbits/s	HDB3, RJ-48 120 Ω
	Bit Rate	Refer to Bit Rate .	
	Sensitivity	DS1 Short Haul:	
	(1.5M)	15 dB linear attenuation , 0 dB cable attenuation, nominal impedance	
		TERMINATE:	
		Up to 36 dB cable attenuation, nominal impedance	
		DSX MONITOR:	
		15 dB to 25 dB linear attenuation, nominal impedance	
		BRIDGED:	
		Up to 36 dB cable attenuation, high impedance	
	Sensitivity (2M)	TERMINATE:	
		Up to 40 dB cable attenuation, nominal impedance	
		MONITOR:	
	20 dB to 26 dB linear attenuation and up to 6 dB cable attenuation, nominal impedance		
	20 dB to 30 dB linear attenuation, 0 dB cable attenuation, nominal impedance		
	BRIDGED:		
	Up to 40 dB cable attenuation, high impedance		

2M to 139/45/156M Input

Bit Rate	Refer to Bit Rate .	
Code/Interface	2.048,34.368 Mbit/s	HDB3, BNC 75 Ω
(Balance)	44.736 Mbits/s	B3ZS, BNC 75 Ω
	139.264,155.52 Mbits/s	CMI, BNC 75 Ω
Sensitivity	TERMINATE:	
(2.048Mbit/s)	Up to 40 dB cable attenuation, nominal impedance	
	MONITOR:	
	20 dB to 26 dB linear attenuation and up to 6 dB cable attenuation, nominal impedance	
	20 dB to 30 dB linear attenuation, 0 dB cable attenuation, nominal impedance	
	BRIDGED:	
	Up to 40 dB cable attenuation, high impedance	
Sensitivity	TERMINATE:	
(34.368/44.736Mbit/s)	Up to 12.0 dB cable attenuation, nominal impedance	
	MONITOR:	
	20 dB linear attenuation and up to 12 dB cable attenuation, nominal impedance	
	20 dB to 30 dB linear attenuation , 0 dB cable attenuation, nominal impedance	
Sensitivity	TERMINATE:	
(139.264/155.52Mbit/s)	Up to 12.0 dB cable attenuation, nominal impedance	
	MONITOR:	
	20 dB linear attenuation and up to 12 dB cable attenuation, nominal impedance	

10/100 /1000M Input

Bit Rate	Refer to Bit Rate .	
Code/Interface	RJ-45	
	IEEE802.3-2008 10BASE-T, 100BASE-TX, 1000BASE-T compliant	
Return Loss	ITU-T G.703 compliant	

Jitter generation

Optical interface:	ITU-T G.783 compliant
Electrical interface:	ITU-T G.823, ANSI T1.403, ANSI T1.404 compliant

Jitter Tolerance

Optical interface:	ITU-T G.825, ITU-T G.8251 compliant
Electrical interface:	ITU-T G.823, ITU-T G.824 compliant

Rx Bit Rate counter

Bit Rate	Refer to Bit Rate .
Accuracy	According to the Internal Clock of MT1000A.

1 PPS Phase Comparison

Compares the phase between Ref 1PPS Input from AUX I/O and 1PPS Input when MT1000A-005 and MU100090A are combined.	
Accuracy:	±5 ns

12.2.3 Environment Performance

Battery operating time	Operating time: 4 hours (Typ.)
	25°C, Depending on operating condition

Specifications

Temperature and Humidity range	Operating: 0°C to +50°C, ≤85%RH (non-condensing) -30°C to +60°C, ≤90%RH (Excluding battery and AC adapter) Storage: -20°C to +50°C, ≤90%RH (Including battery and AC adapter) (non-condensing)
Laser Safety	IEC 60825-1:2007 Class 1 FDA 21 CFR 1040.10 and 1040.11 except for deviations pursuant to [Laser Notice No.50] dated 2007-June-24.
EMC	EN61326-1 and EN61000-3-2.
LVD	EN61010-1.

12.2.4 Mechanical Performance

Size	MU100010A only: 163(H) x 257.6 (W) x 38.5(D) (Excluding projections) When combined to MT1000A: 163(H) x 257.6 (W) x 77(D) (Excluding projections)
Mass	MU100010A only: 1.1 kg max. When combined to MT1000A: 2.7 kg max. (Including battery (G0310A))

12.3 MU100011A 100G Multirate Module

In the following you find specifications for the Network Master Pro MU100011A module. The MU100011A specification lists the functionality added to the basic Network Master Pro by installing the MU100011A option. Refer to the [MT1000A](#) section for further information about the Network Master Pro's basic functionality.

12.3.1 Configuration

	- Module -
MU100011A	100G Multirate Module
	- Options -
MU100011A-ES210	2 Years Extended Warranty Service
MU100011A-ES310	3 Years Extended Warranty Service
MU100011A-ES510	5 Years Extended Warranty Service
	- Basic Option (Software) -
MU100011A-x01	Up to 10G Single Channel
MU100011A-x03	Up to 10G Dual Channel
	- Protocol Option (Software) -
Ethernet:	
MU100011A-x13	Ethernet 40G Single Channel
MU100011A-x15	Ethernet 100G Single Channel
MU100011A-x17	Ethernet 25G Single Channel
MU100011A-x20	TCP Throughput
MU100011A-x23	RS-FEC for 100GBASE-SR4
OTN:	
MU100011A-x53	OTN 40G Single Channel
MU100011A-x55	OTN 100G Single Channel
MU100011A-x62	ODU Flex
MU100011A-x63	ODU Multiplexing/Multistage
CPRI/OBSAI:	
MU100011A-x71	CPRI/OBSAI Up to 10G Single Channel
MU100011A-x72	CPRI/OBSAI Up to 10G Dual Channel
MU100011A-x73	CPRI 12/25G Single Channel
MU100011A-x74	CPRI 12/25G Dual Channel
MU100011A-x75	eCPRI/RoE 25G Dual Channel
SDH/SONET:	
MU100011A-x83	STM-256/OC-768 Client Signal
Fibre Channel:	
MU100011A-x04	FC Up to 10G Single Channel
MU100011A-x05	FC Up to 10G Dual Channel
MU100011A-x91	FC 16G Single Channel

12.3.2 External Interfaces

Test signal interface	CFP4:	1 Slot (Port 1) CFP MSA CFP4 Hardware Specification, Rev. 1.1 compliant CFP MSA Management Interface Specification V2.2 R06a compliant (excluding MSA 100GLH support) IEEE 802.3ba-2010 compliant
	QSFP28, QSFP+:	1 Slot (Port 1) SFF-8436, SFF-8472, SFF-8665 compliant IEEE 802.3ba-2010 compliant
	SFP, SFP+, SFP28:	2 Slots (Port 1, Port 2) SFF-8665, SFF-8431, SFF-8472 compliant IEEE 802.3ae-2002, IEEE802.3-2008 compliant
	RJ45:	2 Sockets (Port 1, Port 2) IEEE802.3-2008 10BASE-T, 100BASE-TX, 1000BASE-T compliant Auto MDI-X 10/100 Mbps Full/Half Duplex, 1000 Mbps Full Duplex

Bit Rate	Standard	Bit Rate	Interfaces
	10BASE-T:	12.5 Mbit/s	RJ-45
	100BASE-TX:	125 Mbit/s	RJ-45
	1000BASE-T:	1.25 Gbit/s	RJ-45
	100BASE-X:	125 Mbit/s	SFP
	1000BASE-X:	1.25 Gbit/s	SFP, SFP+
	10GBASE-X:	10.3125 Gbit/s	SFP+
	25GbE:	25.781250000 Gbit/s × 1 Lane	SFP28
	40GbE:	10.312500000 Gbit/s × 4 Lanes	QSFP+
	100GbE:	25.781250000 Gbit/s × 4 Lanes	QSFP28
	100GbE:	25.781250000 Gbit/s × 4 Lanes	CFP4
	OTU1:	2.666057143 Gbit/s	SFP
	OTU2:	10.70922532 Gbit/s	SFP+
	OTU1e:	11.04910714 Gbit/s	SFP+
	OTU2e:	11.09572785 Gbit/s	SFP+
	OTU1f:	11.27008929 Gbit/s	SFP+
	OTU2f:	11.31764241 Gbit/s	SFP+
	OTU3:	10.75460339 Gbit/s × 4 Lanes	QSFP+
	OTU3e1:	11.14274364 Gbit/s × 4 Lanes	QSFP+
	OTU3e2:	11.14583889 Gbit/s × 4 Lanes	QSFP+
	OTU4:	27.952493392 Gbit/s × 4 Lanes	QSFP28
	OTU4:	27.952493392 Gbit/s × 4 Lanes	CFP4
	STM-1/OC-3:	155.52 Mbit/s	SFP
	STM-4/OC-12:	622.082 Mbit/s	SFP
	STM-16/OC-48:	2488.32 Mbit/s	SFP
	STM-64/OC-192:	9953.28 Mbit/s	SFP+
	16GFC:	14.025 Gbit/s	SFP+
	10GFC:	10.51875 Gbit/s	SFP+
	8GFC:	8.5 Gbit/s	SFP+
	4GFC:	4.25 Gbit/s	SFP, SFP+
	2GFC:	2.125 Gbit/s	SFP, SFP+
	1GFC:	1.0625 Gbit/s	SFP
	CPRI1:	614.4 Mbit/s	SFP
	CPRI2:	1228.8 Mbit/s	SFP
	CPRI3:	2457.6 Mbit/s	SFP, SFP+
	CPRI4:	3072.0 Mbit/s	SFP, SFP+
	CPRI5:	4915.2 Mbit/s	SFP+
	CPRI6:	6144.0 Mbit/s	SFP+
	CPRI7:	9830.4 Mbit/s	SFP+
	CPRI8:	10137.6 Mbit/s	SFP+
	CPRI9:	12165.12 Mbit/s	SFP+
	CPRI10:	24330.24 Mbit/s	SFP28
	OBSAI 1x:	768 Mbit/s	SFP
	OBSAI 2x:	1536 Mbit/s	SFP, SFP+
	OBSAI 4x:	3072 Mbit/s	SFP, SFP+
	OBSAI 8x:	6144 Mbit/s	SFP+

Simultaneous measurement ports

Simultaneous measurement using two ports is available under following condition.

- Both applications belong to the same technology in Application Selector screen. If both applications locate in the same row in Application Selector, simultaneous measurement of them is available even if OTN layer is added (+OTN). As an exception, eCPRI/RoE of Mobile xHaul is a different technology from CPRI/OBSAI and belongs to Ethernet technology.
✓ : Supported

Port 1	Port 2	Not used	OTN	Ethernet		eCPRI/RoE			Fibre Channel	SDH/SONET	CPRI/OBSAI	Device Test
				10G max.	25-100G	10G max.	25G	40-100G				
Not used			✓	✓	✓	✓	✓	✓	✓	✓	✓	✓
OTN		✓	✓									
Ethernet	10G max.	✓		✓		✓						
	25-100G	✓										
eCPRI/RoE	10G max.	✓		✓		✓	✓(*1)					
	25G	✓				✓(*1)	✓(*1)					
	40-100G	✓										
Fibre Channel		✓						✓(*2)				
SDH/SONET		✓							✓			
CPRI/OBSAI		✓								✓		
Device Test		✓										✓

*1 When 25G eCPRI/RoE Dual Port Ability is selected.

*2 FC1200 or lower

**Frequency variable range
Electrical Output**

Relative to [Bit Rate](#): -200ppm to + 200ppm, 0.1ppm step

Sync Clock Output

Frequency
 100GbE/25GbE: Divided 1/8 or 1/16 from Lane Bit rate:
 3.22265 GHz (1/8), 1.61133 GHz (1/16)
 OTU4: 3.49406 GHz (1/8), 1.74703 GHz (1/16)
 Level 350 mVp-p min.
 650 mVp-p max.
 Connector SMA female
 Termination 50 Ω, AC coupling, single-end

12.3.3 Environment Performance

Battery operating time

Operating time: 1.5 hours (Typ.)

25°C, Depending on operating condition

Temperature and Humidity range

Operating: 0°C to +45°C, ≤85%RH (non-condensing)

Storage: -30°C to +60°C, ≤90%RH (Excluding battery and AC adapter)
 -20°C to +50°C, ≤90%RH (Including battery and AC adapter)
 (non-condensing)

Laser Safety	IEC 60825-1:2007 Class 1M CFP4: 100GBASE-SR4 QSFP28: 100GBASE-SR4 QFP+: 40GBASE-SR4 SFP28: 25GBASE-SR FDA 21 CFR 1040.10 and 1040.11 except for deviations pursuant to [Laser Notice No.50] dated 2007-June-24. IEC 60825-1:2007 Class 1 CFP4: 100GBASE-LR4 QSFP28: 100GBASE-LR4 QFP+: 40GBASE-LR4 SFP28: 25GBASE-LR SFP+: 1000BASE-SX, 1000BASE-LX, 1000BASE-ZX SFP+: 10GBASE-LR, 10GBASE-ER, 10GBASE-ZR SFP: 4G FC(SX), 4G FC(LX), 4G FC(EX), OC-48 LR-1/STM L-16.1, OC-48 LR-2/STM L-16.2, 100BASE-FX, 100BASE-LX FDA 21 CFR 1040.10 and 1040.11 except for deviations pursuant to [Laser Notice No.50] dated 2007-June-24.
EMC	EN61326-1 and EN61000-3-2.
LVD	EN61010-1.

12.3.4 Mechanical Performance

Size	MU100011A only: 165(H) x 257.6 (W) x 48(D) (Excluding projections) When combined to MT1000A: 163(H) x 257.6 (W) x 89(D) (Excluding projections)
Mass	MU100011A only: 1.5 kg max. When combined to MT1000A: 3.1 kg max. (Including battery (G0310A))

12.4 MU100090A High Performance GPS Disciplined Oscillator

The following sections describe the specifications for the Network Master Pro MU100090A module.

12.4.1 Configuration

	- Module -	
MU100090A	High Performance GPS Disciplined Oscillator	
	- Standard Accessory -	
J1705A	AUX Conversion Adaptor	1
J1706A	GPS Antenna	1
J1710A	BNC Cable (20cm)	2
	- Options -	
MU100090A-ES210	2 Years Extended Warranty Service	
MU100090A-ES310	3 Years Extended Warranty Service	
MU100090A-ES510	5 Years Extended Warranty Service	
	- Optional Accessory -	
J1705A	AUX Conversion Adaptor	
J1706A	GPS Antenna	
J1710A	BNC Cable (20cm)	

12.4.2 Electrical performance and function

Internal Clock	Rubidium oscillator
	Aging:
	2.5×10^{-11} (Daily)
	1×10^{-10} (Monthly)
	1×10^{-9} (Yearly)
External Interfaces	10MHz Clock Output Connector: BNC Jack Level: TTL, 50 Ω
	1PPS Output Connector: BNC Jack Level: TTL, 50 Ω Holdover: 300 ns per 10000 s
	Holdover should be executed after Rubidium oscillator is:
	<ul style="list-style-type: none"> • turned power on for three hours or more and • synchronized with GPS or external 1PPS for 30 minutes or more
	At constant temperature
	1PPS Sync Input Makes built-in Rubidium oscillator synchronize with 1PPS. Connector: BNC Jack Level: TTL, 50 Ω Input Frequency Range: ± 10 ppb

Antenna	Connector: SMA Jack Feeding Antenna: +3.3 V, +5 V (Selectable, 50 mA max.)
AUX	Connector: D-sub 9 pin
LED indicator	GPS: Lights when receiving signals of four or more satellites (green). OSC: Lights when the oscillator is locking to the signal (green).

12.4.3 GPS Synchronization

Supported Signal	GPS L1 C/A Code
Number of receivable channels	50
Synchronization accuracy (to UTC time)	45 ns rms After Rubidium oscillator is: <ul style="list-style-type: none"> • turned power on for three hours or more and • synchronized with GPS or external 1PPS for 30 minutes or more At constant temperature

12.4.4 Environment Performance

Power	DC: 18 V Power consumption: 20 W max. (65 W max. when combined with MT1000A)
Temperature range	Operating: 0 to +50°C, ≤85%RH (non-condensing) Charging battery: 0 to +40°C, ≤85%RH (non-condensing) Storage: -30 to +60°C, ≤90%RH ((Excluding battery and AC adapter) -20 to +50°C, ≤90%RH (Including battery and AC adapter) (non-condensing)
EMC	EN61326-1, EN61000-3-2
LVD	EN61010-1

12.4.5 Mechanical Performance

Size	MU100090A only: 163(H) x 257.6 (W) x 25(D) (Excluding projections) When combined to MT1000A and MU100010A: 163(H) x 257.6 (W) x 102.2(D) (Excluding projections)
Mass	MU100090A only: 0.8 kg max.

12.5 Measurement Functionality

12.5.1 Ethernet Measurements

Cable test	Identifies failures on electrical cables like short-circuits or breaks of a wire pair and indicates the distance from the instrument to the fault.
Transmitter Clock	Reference Clock <ul style="list-style-type: none">• Internal clock• External clock<ul style="list-style-type: none">◦ BITS◦ SETS◦ 2MHz◦ 10MHz• GPS• Received clock• IEEE1588v2
Frequency deviation measurement	Refer to Bit Rate of MU100010A and Bit Rate of MU100011A.
Frequency Offset	MU100010A: ± 100 ppm 1 ppm step MU100011A: ± 200 ppm 0.1 ppm step
SyncE functionality	<p>Specify quality level (QL) of the transmitted Ethernet signal.</p> <p>SyncE functionality is available when the interface bit rate is 10Gbps or less.</p> <p>Analysis of QL indicated in received Ethernet signal. An alarm is raised on missing QL indications.</p> <p>SyncE results</p> <ul style="list-style-type: none">• SSM Rx count and rate• SSM Tx count• Indicated QL statistics• SSF seconds <p>ESMC messages capture</p> <ul style="list-style-type: none">• ESMC messages can be captured and exported in a Wireshark compatible format.
IEEE 1588v2 functionality	<p>Timing master/slave</p> <ul style="list-style-type: none">• Each port of the Ethernet interface can act as a timing master or a timing slave independently, except ports for 40GbE and 100GbE. <p>Supported modes: Multicast (native PTP) and Unicast (G.8265.1). When acting as master in Unicast (G.8265.1) mode, one slave is accepted at a time, other slaves are ignored. If the slave requires 32, 64 or 128 Sync messages per second, the IEEE 1588-2008 paragraph 7.7.2.1 concerning 90% confidence interval is not followed.</p> <p>Configurable parameters (per port):</p> <ul style="list-style-type: none">• Clock identity• Port number• Priority 1

- Priority 2
- Domain number
- Clock class
- Slave only mode
- Time source
- Encapsulation
- Announce receipt timeout
- Clock accuracy
- Clock step mode
- Announce interval
- Sync interval
- Minimum delay request interval

IEEE 1588 clock results:

- Clock state
- Announce count
- Sync count
- Follow-up count
- Delay request count
- Delay response count
- Delay follow-up count
- Peer delay request/response/response-follow-up counters
- Maximum/Minimum/Average offset
- Maximum/Minimum/Average offset deviation
- Maximum/Minimum/Average offset variance
- Maximum/Minimum/Average mean path delay
- Maximum/Minimum/Average peer mean path delay
- Maximum/Minimum/Average path delay variation

UTC time offset

- With a GPS signal present, the offset from UTC time is calculated.

Parent clock results:

- Identity and Port number.

Grand-master results:

- Identity
- Class
- Accuracy
- Priority 1
- Priority 2
- Announced- and observed offset variance.

Foreign master clock results (up to five clocks per port):

- Identity
- Port number and Announce count

The following IEEE 1588 events are counted and logged:

- Clock state transitions
 - State transition events
 - Faults and Changes in grand-master clock

IEEE 1588 messages can be captured and exported in a Wireshark compatible format.

WAN

Terminology
SDH, SONET

Transmitter, Receiver Supported encapsulations (frame formats)

- EtherType II (DIX v.2)
- IEEE 802.3 with 802.2 (LLC1)
- IEEE 802.3 with SNAP

Variable line rate traffic generation

- Up to full line rate

Transmitter Frame size

- From 44 bytes to 16,000 bytes

Receiver settings

- User-defined expected preamble length (3 to 15 bytes)
- User-defined IFG lower threshold * (8 to 15 bytes)
- User-defined Jumbo frame size upper limit (1519 to 16000 bytes)

*: Only for Ethernet 10/100/1000 Mbps (cannot use 10Gbps)

Traffic generator

Line load profile

- Constant: 0.0008% - 100%
- Ramp:
 - Line load: start, end, step (0.0001% resolution)
 - Duration: 3 to 3600 seconds
 - Ramp mode: Keep end line load, Repeat ramp, Invert ramp

Frame size profile

- Constant
- Stepped:
 - Frame size: start, end, step (to 16000 bytes)
 - Duration: 1 to 3600 seconds
- Random:
 - Frame size: start, end (to 16000 bytes),
User-defined TCP/UDP frame size upper limit (2048 bytes)

Traffic duration

- Continuous
- Seconds: 1 to 2,000,000,000
- Frames: 1 to 2,000,000,000

Unicast/broadcast

- User-defined traffic mix of unicast and broadcast frames

VLAN

- User-defined VLAN ID and VLAN priority

Address

- Configurable IP and Ethernet source and destination addresses (supports IPv4 and IPv6 addressing). Fixed, DHCP, DNS.

Flow control

- Generate pause frames
- Respond to pause frames

ARP

- Answer incoming ARP request On/Off

IP

- Fixed or incremented IP identifier
- User programmable DSCP/TOS byte

UDP/TCP

- User programmable UDP/TCP address
- UDP Checksum: automatic or fixed (null)
- TCP checksum: automatic

Status, Results

Status

- Link status, RF, Signal present, Jabber detected, Frames present, Speed, Full or half duplex, Interface type, Local clock (Ethernet 1000), Pause capable and Asymmetric pause request (excluding 10Gbps), Link partner capabilities (excluding 10Gbps)

Resolution

- User-defined resolution for statistical measurements:
1, 2, 5, 10, 15, 30s, 1, 5, 15, 30 minutes, 1, 2, 4, 6, 12 hours.

Performance statistics

- Maximum/Minimum/Average utilization
- Maximum/Minimum/Average user and total throughput
- Maximum/Minimum/Average frame rate
- Maximum/Minimum/Average frame latency
- Maximum/Minimum/Average packet jitter

Frame statistics

- Total frames
- Total valid frames
- Unicast/multicast/broadcast frames
- Pause frame
- VLAN frame
- MPLS frames
- MPLS-TP frame
- PBB frame
- VLAN Max/Min level
- MPLS Max/Min level
- Fragmented frames
- Oversized and Undersized frames

- FCS errored frames
- Error symbolized frames (Excluding 10Gbps)
- Code violation frames (For 10Gbps)
- Collisions (10/100 Mbps half duplex)
- Preamble Violations
- IFG violations
- Local Fault (For 10Gbps)
- Remote Fault (For 10Gbps)
- Last Received VLAN 1-8 (ID/Priority)
- Last Received MPLS 1-8 (Label/Priority/TTL)
- B-Tag, I-tag (ID/Priority)

Burst statistics

Disabled in case of the OTN client.

- Total frames in burst
- Good/Bursted frames
- Number of Bursts
- Maximum/Minimum/Average burst size

Frame distribution statistics

- Total valid/good frames
- 64 - 127 byte frames
- 128 - 255 byte frames
- 256 - 511 byte frames
- 512 - 1023 byte frames
- 1024 - 1518 byte frames
- Total number of jumbo frames
- Maximum/Minimum/Average frame size

Filters

Up to 8 filter conditions can be defined. Each condition can filter on:

- IP or MAC source address
- IP or MAC destination address
- Broadcast address
- IEEE OUI value
- Encapsulation type
- VLAN ID
- VLAN tag priority
- MPLS
- MPLS-TP source/destination MAC
- PBB source/destination MAC
- PBB I-tag/B-tag
- TCP/UDP source and destination port
- User-defined pattern at a defined offset

Adjustable thresholds

- Utilization
- Throughput
- Errored frames
- Collision rate

- Unicast frames
- Multicast frames
- Broadcast frames
- Pause frames
- Fragmented frames
- Undersized frames
- Oversized frames
- FCS errored frames
- IFG violations (Ethernet 10/100/1000 Mbps)
- Preamble violations
- Difference between Tx and Rx

DHCP

- Show source IP address assigned by DHCP.
- Show current lease expire time.
- Show IP addresses of primary and secondary DNS server when obtained by DHCP.

Error generation

For LAN

- IFG (For 10/100/1000 Mbps), FCS, Preamble, Error symbol/block
- Wrong IP checksum, fragmented IP, Wrong layer4 checksum
- BERT Pattern error, BERT sequence error

For WAN

- SDH:
A1A2, B1, B2, MS-REI, B3, HP-REI
- SONET:
A1A2, B1, B2, REI-L, B3, REI-P

For PCS

- Invalid block type (0x00, 0x2d, 0x33, 0x66), Invalid sync header (00, 11), Invalid alignment marker, BIP error

Alarm generation

For LAN

- No link
- Local fault (For 10 Gbps, 25 Gbps, 40 Gbps, 100 Gbps)
- Remote fault

For WAN

- SDH:
LOS, LOF, OOF, MS-TIM, MS-AIS, MS-RDI, AU-AIS, AU-LOP, HP-TIM, HP-PLM, HP-UNEQ, HP-RDI, LCD
- SONET:
LOS, LOF, OOF, TIM-S, AIS-L, RDI-L, AIS-P, LOP-P, TIM-P, PLM-P, UNEQ-P, RDI-P, LCD-P

For PCS

- High BER (For 40Gbps, 100 Gbps)

PCS Skew Insertion

Bits:

0 to 4224 (For 100 Gbps Tx lane),
0 to 8448 (For 40 Gbps, 100 Gbps Physical lane)

WAN OH Capture

Item

- SOH/TOH: 64 Frames
- POH: 64 Frames
- Pathtrace:J0/J1/J2 (Displays in ASCII characters)

Timing

- Single
- Repeat : Update period 1s

Frame Capture

Buffer size

1, 2, 4, 8, 16, 32, 64, 128 MB for 10M/100M/1000M/10G interface
512 KB for 25G, 40G, and 100G interface

Frame slicing

Whole frame, Top 64 Bytes, Top 32 Bytes

Buffer handling

Stop when full, Overwrite

Capture transmitted frames

on, off

Trigger Type

Manual, Error, Field match

Trigger Position

Top, Middle (Only when Trigger Type is Error/Field match)

Error Type

Any Type, Fragment, Oversize or undersize, Oversize, Undersize, FCS error

Transceiver

Module Present

Transceiver Information

Alarm, Wavelength and bit rate, Compliance, Vendor Information, Output Control

Power monitor

MDIO analysis

For CFP4:

NVR1, NVR2, Module FAWS, MW Lane FAWS, CTRL, MDIO Read/Write

I2C analysis

For QSFP+ and QSFP28:

Lower, Lower (Lane), Upper (00), Upper (03), Read/Write

For SFP, SFP+, and SFP28:

Memory A0h, Memory A2h, Read/Write

Setting

VOD, Pre, Post, DFE

BER test

Generation and detection of test patterns. Count of errors in received test pattern. Pattern generation:

- Unframed (layer 1)

- Framed with Ethernet (MAC) header (layer 2)
- Framed with Ethernet (MAC) header and IP header (layer 3)
- Framed with Ethernet (MAC) header, IP header and UDP/TCP header (layer 4)

Test patterns:

- PRBS 9, PRBS 11, PRBS 15, PRBS 20, PRBS 23, PRBS 29, PRBS 31, HF test pattern, CRPAT, JTPAT, SPAT
- User-defined up to 32 bits. Length in step of 1 bit.

Detection of sequence errors and loss of sequence synchronization.

Frame loss count and frame loss seconds.

Throughput measurement: Maximum/Minimum/Average values are presented.

Test resolution

- User-defined up to resolution:
1, 2, 5, 10, 15, 30 sec, 1, 5, 10, 15, 30 minutes, 1, 2, 4, 6, 12 hours
- No intervals

Throughput measurement

Throughput may be calculated on 6 different layers:

- Utilization layer
- Physical layer
- Physical layer excl. preamble
- Link layer
- Network layer
- Data layer

Service disruption measurement

Can be activated as part of the BER test:

- Maximum/Average service disruption time, resolution 0.1 μ sec
- Number of service disruptions

Ping test

For the connectivity check through the network.

- Round Trip Time (RTT)
- Supports IPv4 addressing
- Answer incoming Ping requests (On/Off)

Traceroute

Trace the IP route over the IP network.

- User-defined max no. of hops (1 to 255)
- Information per hop: Maximum/Minimum/Average ping time and number of ping timeouts

Ethernet OAM option

- Y.1731 (Service Layer OAM)
- IEEE 802.1ag (Connectivity layer OAM) and IEEE 802.3ah (Access Link OAM)

VLAN

Number of VLAN tag

- Up to 8 layers of VLAN can be inserted into the Ethernet frame.
Only 1 level of VLAN is supported in ping, Traceroute and RFC2544 router latency tests.

Parameters per VLAN tag

- EtherType 0x8100 (802.1Q), 0x88a8 (802.1ad), 0x9100 or 0x9200

- User-defined VLAN ID, CFI and VLAN priority

Status

- Indicator for detection of VLAN tagged frames

Statistics

- Number of VLAN tagged frames
- Maximum number of VLAN layers detected

Ethernet MPLS

MPLS supported

- MPLS unicast is supported (EtherType 0x8847).
- Support for MPLS in BERT, RFC 2544 (excluding router latency) tests and general statistics

Number of MPLS headers

- Up to 8 MPLS headers can be set by the user.

Parameters per MPLS header

- User-defined label, Exp and TTL fields in each MPLS header

MPLS-TP support

- PWE (Pseudo Wire Emulation Edge-to-Edge) label (the RFC4448 control word) can be added.

Status

- Indicator for detection of MPLS frames and MPLS-TP

Statistics

- Number of MPLS frames and MPLS-TP frames
- Maximum number of MPLS layers detected

Ethernet Multistream

Number of streams

Up to 16 streams can be activated on the Ethernet line.

Parameters per stream

- Encapsulation (frame format)
- Line rate traffic load, up to full line rate
- Configurable IP and Ethernet source and destination addresses (supports IPv4 and IPv6 addressing)
- User-defined traffic mix of unicast and broadcast frames
- Adjustable frame size from 44 bytes to 16000 bytes
- Frame sizes may be set to constant, stepped or random length.
- User programmable VLAN ID and VLAN priority
- User programmable DSCP/TOS byte
- User programmable UDP/TCP address

In stream 1 a BER test can be made.

Statistics

Available information per stream:

- Frame loss count/rate
- Frames and bytes received
- Frames and bytes transmitted
- Throughput
- Latency/Jitter

RFC2544 installation and commissioning

Switch/router test and Single ended network test modes:

- Throughput
- Frame loss
- Latency or packet jitter
- Back-to-back frames (burstability)

End-to-end network test mode (two Network Master Pros in a master-slave setup)

- Throughput
- Frame loss
- Back-to-back frames (burstability)

Router latency test mode: IP ping based latency test or packet jitter.

For RFC2544 throughput measurement the user can choose to make the measurement for:

- Physical layer
- Physical layer excl. preamble
- Link layer
- Network layer
- Data layer
- Average or maximum values

RFC6349 TCP throughput test

Supports connecting to iPerf server.

Test Direction Setup

- Local -> Remote
- Remote -> Local
- Simultaneous in Both Direction

For RFC6349 test sequence the user can choose to make the measurement for:

- Path MTU
- Baseline RTT
- Window Scan and Throughput
- Multi-Service

Multi-Service: DSCP or TOS can be set to each TCP connections.

- Destination Port
- DSCP or TOS

Service Activation Test (Y.1564)

Service Activation Test is an out-of-service test to assess the proper configuration and performance of Ethernet services.

- Test up to 8 services
- Color-Aware and Non-Color-Aware in combinations (IP DSCP or VLAN PCP)
- GPS timing synchronization

Two test modes:

- One-way (uni- or bi-directional, symmetrical or asymmetrical)
- Round-trip

Service Configuration Test:

- With subtests for:
 - Committed Information Rate
 - Excess Information Rate
 - Traffic Policing
 - Committed Burst Size
 - Excess Burst Size
- Step duration: 1 sec to 60 sec (user programmable)
- Number of steps: 1 to 10 (user programmable)
- Slope: rising or falling
- Results:
 - Pass/Fail indication
 - IR (Maximum/Minimum/Average)
 - FL (Count/FLR)
 - FTD and FDV (Maximum/Minimum/Average/Current (during measurement))

Service Performance Test:

- All services tested simultaneously at CIR
- Duration: 15 minutes, 2 hours, 24 hours or customer programmable
- Results:
 - Pass/Fail indication
 - IR (Maximum/Minimum/Average)
 - FL (Count/FLR)
 - FTD and FDV (Maximum/Minimum/Average/Current (during measurement))
 - AVAIL (%)
 - Unavail (sec)

Verification against Service Acceptance Criteria:

- Information Rate
- Frame Transfer Delay
- Frame Delay Variation
- Frame Loss Rate
- Availability

IP Channel Statistics IP Channel Statistics is available when the interface bit rate is 10Gbps or less.

Number of channels

The statistics are provided for up to 230 channels, identified by user-defined combinations of:

- IPv4, IPv6 or MAC address
- VLAN ID or MPLS label
- Protocol information
- IP next header (protocol)
- TCP/UDP ports.

Statistics

Available information per channel:

- Frame statistics
 - Frame count/rate
 - Throughput
 - Byte count
 - Undersize frames
 - Oversize frames
- Size distribution
 - IP Frame/packet size distribution
- MPLS statistics
 - MPLS/IP frames
 - MPLS/IP bytes
- IP statistics
 - IP packet count, rate
 - IP bytes
 - IP throughput
 - IP header bytes
 - IP fragments
 - TTL threshold violations
- IPv4 statistics
 - IPv4 packet count, rate
 - IPv4 bytes
 - IPv4 throughput
 - IPv4 header bytes
 - IPv4 header errors
- IPv6 statistics
 - IPv6 packet count, rate
 - IPv6 bytes
 - IPv6 throughput
 - IPv6 header bytes
- TCP/UDP statistics
 - TCP/UDP packets, rate
 - TCP/UDP bytes
 - TCP/UDP throughput
 - TCP/UDP errored packets

Reflector mode

The following parameters are user-settable:

- Swap all MAC addresses or one specific MAC address
- Swap IP addresses
- Swap port numbers on UDP/TCP frames
- Force ACK on TCP frames

Sync Test

The following parameters are user-settable:

- Internal length
- Measurement period
100 s, 1000 s, User Defined
- 1PPS cable correction
- Ethernet cable correction

Statistics

Available information per channel:

- Frame statistics
 - Frame count/rate
 - Throughput
 - Byte count
 - Undersize frames
 - Oversize frames
- Transmit
 - Error frames
 - Frame size distribution
- IEEE1588v2 statistics
 - Offset Stat.
 - Offset Variance
 - Mean Path Delay
 - Path delay variation (PDV)
 - Message Stat.
 - Signalling
 - Clock Status Stat.
 - GPS-Wall clock
- Sync Test statistics
 - 1PPS deviation
 - Phase error
 - Filtered TE
 - Sync OWD
 - Follow up OWD
 - Delay Req. OWD

Discovery

Number of Network Masters to be discovered: Up to 16 Network Masters

Search type:

- Multicast search for inside IP network
- Unicast search for inside and outside IP network

Application Change:

- Available application to change: Reflector, RFC 2544, RFC 6349, SAT(Y.1564), Discovery
- Settings: Password, Source MAC address, Destination MAC address, VLAN, Source IP address, Destination IP address, Gateway, Increment to all streams

12.5.2 SDH/SONET/PDH/DSn

SONET/SDH switchable.

Number of ports

Max. 2

Transmitter Clock

Reference Clock

- Internal clock
- External clock
 - BITS
 - SETS
 - 2MHz
 - 10MHz

- Received clock

Frame format

- STM-1/STM-1e/OC-3/STS-3
- STM-4/OC-12
- STM-16/OC-48
- STM-64/OC-192

For bit rate, refer to [Bit Rate](#) of MU100010A and [Bit Rate](#) of MU100011A.

Measurement Parameter

Interval

1s, 2s, 5s, 10s, 15s, 30s,
1minute, 5minutes, 10minutes, 15minutes, 30minutes,
1hour, 2hours, 4hours, 6hours, 12hours,
No intervals

Start Key Action

Immediate
Start at(year-month-day, hour-minute-second)

Stop Function

Manual Stop
Stop at (year-month-day, hour-minute-second)
Duration (1second to 99days 23hour-59minute-59second)

12.5.2.1 SDH**SDH Mappings**

STM-64 - AU4-64c - VC4-64c - Bulk
 STM-64/STM-16 - AU4-16c - VC4-16c - Bulk
 STM-64/STM-16/STM-4 - AU4-4c - VC4-4c - Bulk
 STM-64/STM-16/STM-4/STM-1/STM-1e - AU-4 - VC-4 - Bulk
 STM-64/STM-16/STM-4/STM-1/STM-1e - AU-4 - VC-4 - E4
 STM-64/STM-16/STM-4/STM-1/STM-1e - AU-4 - VC-4 - TU-3 - VC-3 - Bulk
 STM-64/STM-16/STM-4/STM-1/STM-1e - AU-4 - VC-4 - TU-3 - VC-3 - DS3
 STM-64/STM-16/STM-4/STM-1/STM-1e - AU-4 - VC-4 - TU-3 - VC-3 - E3
 STM-64/STM-16/STM-4/STM-1/STM-1e - AU-4 - VC-4 - TU-12 - VC-12 - Bulk
 STM-64/STM-16/STM-4/STM-1/STM-1e
 - AU-4 - VC-4 - TU-12 - VC-12 - E1 (Async/Sync)
 STM-64/STM-16/STM-4/STM-1/STM-1e
 - AU-4 - VC-4 - TU-11 - VC-11 - Bulk
 STM-64/STM-16/STM-4/STM-1/STM-1e
 - AU-4 - VC-4 - TU-11 - VC-11 - DS1 (Async/Sync)
 STM-64/STM-16/STM-4/STM-1/STM-1e - AU-3 - VC-3 - Bulk
 STM-64/STM-16/STM-4/STM-1/STM-1e - AU-3 - VC-3 - DS3
 STM-64/STM-16/STM-4/STM-1/STM-1e - AU-3 - VC-3 - E3
 STM-64/STM-16/STM-4/STM-1/STM-1e - AU-3 - VC-3 - TU-12 - VC-12 - Bulk
 STM-64/STM-16/STM-4/STM-1/STM-1e
 - AU-3 - VC-3 - TU-12 - VC-12 - E1 (Async/Sync)
 STM-64/STM-16/STM-4/STM-1/STM-1e - AU-3 - VC-3 - TU-11 - VC-11 - Bulk
 STM-64/STM-16/STM-4/STM-1/STM-1e
 - AU-3 - VC-3 - TU-11 - VC-11 - DS1 (Async/Sync)

Dummy channel handling

Copy, Unequipped (For AU only)

Test patterns

- PRBS: 2⁹-1, 2¹¹-1, 2¹⁵-1, 2²⁰-1, 2²³-1, 2²⁹-1, 2³¹-1 (Normal/Inverse)
- Fixed :User Pattern, All0, All1, Alternating 1:1, Alternating 1:3, Alternating

1:7, 2 in 8

- User Pattern : 32 bit, 2048 bit

Preset data

OH Preset data

- SOH : All bytes except B1, B2, H1, H2 and H3 byte
- VC-4/VC-3 POH : All bytes except B3
- VC-12/VC-11 POH : All bytes except BIP-2

Path trace Setting: J0, J1, J2 (ASCII data, 16 bytes/64 bytes)

Tandem connection

Off, N1(VC-4), N1(VC-3), N2(VC-12), N2(VC-11)

Frequency Offset

MU100010A: ± 50 ppm 1 ppm step
MU100011A: ± 200 ppm 0.1 ppm step

Alarm Insertion

Item

- LOS, LOF, OOF, MS-AIS, MS-RDI, AU-AIS, AU-LOP, HP-TIM, HP-PLM, HP-UNEQ, HP-RDI, TU-AIS, TU-LOP, TU-LOM, LP-TIM, LP-UNEQ, LP-RDI, LP-PLM, LSS, TC-UNEQ, TC-LTC, TC-TIM, TC-AIS, TC-RDI, TC-ODI

Insertion :

- Permanent, Alternate (Excluding LOS, OOF and LSS)
- Permanent (For LOS, OOF and LSS)

Alternate :

- Alarm length : 1 to 8000 (Frame)
- Normal length : 1 to 8000 (Frame)

Error Insertion

Item

- A1A2, B1, B2, MS-REI, B3, HP-REI, V5/B3, LP-REI, TC-IEC, TC-REI, TC-OEI, TC-BIP-2, ERR-TRANS, Pattern error

Insertion :

- Manual, Rate, Alternate (Excluding ERR-TRANS)
- Manual, Rate (For ERR-TRANS)

Manual :

- Burst length : 1 to 8000 (bit) (Excluding Pattern error)
- Burst length : 1 to 4000 (bit) (For Pattern error)

Rate:

- 1×10^{-3} , 1×10^{-4} , 1×10^{-5} , 1×10^{-6} , 1×10^{-7} , 1×10^{-8} , 1×10^{-9} , 1×10^{-10}
The available highest rate varies depending on the error item.

Alternate :

- (Excluding Pattern error)
 - Error : 1 to 8000 (Frame)
 - Normal : 1 to 8000 (Frame)
- (For Pattern error)
 - Error : 1 to 4000 (bit)

- Normal : 100 to 4000 (bit)

Pointer

AU-4, AU-3, TU-3, TU-12, TU-11

Test Sequence :

- No Test Sequence
- Single Alternating
- Regular + Double
- Regular + Missing
- Double Alternating

Movement :

- Positive
- Negative
- Burst: 1 to 100

Jump :

- NDF: Including NDF or Excluding NDF
- Pointer Value: 0 to 782(AU-4/AU-3) or 764(TU-3) or 139(TU-12) or 103(TU-11)

Error/Alarm detection Alarm detection

- LOS, LOF, OOF, MS-AIS, MS-RDI, AU-AIS, AU-LOP, HP-PLM, HP-TIM, HP-RDI, HP-UNEQ, TU-AIS, TU-LOP, TU-LOM, LP-PLM, LP-TIM, LP-RDI, LP-UNEQ, TC-AIS, HP-TC-RDI, HP-TC-ODI, HP-TC-UNEQ, TC-TIM, TC-LTC, TC-AIS, TC-RDI, TC-ODI, TC-UNEQ, LSS

Display : Second (Resolution : 1 second)

Error Detection

- A1A2, B1, B2, MS-REI, B3, HP-REI, V5/B3, LP-REI, TC-IEC, TC-BIP-2, TC-REI, TC-OEI, Pattern error, Pattern block error for G.826

Display : Count, Ratio

Monitor

Signal level:

- dBm (Excluding STM-1e)
- dB (For STM-1e)

Deviation: ppm (Resolution: 1 ppm)

Bit rate: bit/s

Pointer analyze

Pointer value: AU-PTR, TU-PTR

Element : Negative, Positive

Graph : Pointer movement

OH Capture

Item

- SOH: 64 Frames
- POH: 64 Frames
- Pathtrace: J0/J1/J2 (Displays in ASCII characters)

Timing

- Single
- Repeat : Update period 1s

Transceiver Module Present
Transceiver Information
 Alarm, Wavelength and bit rate, Compliance, Vendor Information, Output Control

Power monitor

I2C analysis
 For SFP and SFP+:
 Memory A0h, Memory A2h, Read/Write

Through Mode Mode :

- Through Rx
- OH Overwrite
 - SOH, A1/A2, K1/K2, S1, DCC1-3, DCC4-12, J0, SOH 1byte

Stimuli

- Alarm : LOS, LOF, OOF, MS-RDI
Available alarms depend on Through mode setting.
- Error : A1A2, B1, B2, MS-REI, ERR-TRANS
Available errors depend on Through mode setting.
- Insertion: refer to [Alarm Insertion](#) and [Error Insertion](#)

APS APS (Automatic Protection Switching) Measurement

- Reference event: LOS, LOF, OOF, MS-AIS, MS-RDI, APS Switchover, AU-AIS, AU-LOP, HP-TIM, HP-PLM, HP-UNEQ, TU-LOM, TU-AIS, TU-LOP, LP-TIM, LP-PLM, LP-UNEQ, LSS, A1A2, B1, B2, MS-REI, B3, V5, Pattern errors
- Max reference duration: 0.000 to 10000.000 ms
- Result: Average switching time, Maximum switching time, Minimum switching time

APS Protocol analyze

- APS configuration :Ring or Linear
 - Ring : Short Path, Long Path
 - Linear : 1+1 architecture, 1:n architecture
- APS Protocol Request : The value of K1, K2 byte is sent depending on selected type.
- APS Interpretation : Number, Elapsed Time

Delay measurement Measurement Mode : Single, Repeat

Measurement Period : 0.5, 1, 2, 5,10 s

Measurement Range : Up to 10 000 000.000 μ s / resolution 0.1 μ s, Timeout

SDH Performance Measurement

- Setup : G826, G.828+G.829, M.2101.1(M2100)
- Allocation
 - Mux Allocation 0 to 100%
 - VC-4 Allocation 0 to 100%
 - VC-3 Allocation 0 to 100%
 - VC-11/VC-12 Allocation 0 to 100%

- Time period : 15minutes, 1hour, 2hour, 24hour, 7days (only M.2101.1)
- Result : ES, SES, BBE, UNAV
- Display : Count, Ratio

Tributary Scan Displays the alarm status of all channels in a specified layer.
Green (No alarm), Red (Alarm occurring), Gray (Not applied)

12.5.2.2 SONET

SONET Mappings

OC-192 - STS-192c - STS-192c SPE - Bulk
 OC-192/OC-48 - STS-48c - STS-48c SPE - Bulk
 OC-192/OC-48/OC-12 - STS-12c - STS-12c SPE - Bulk
 OC-192/OC-48/OC-12/OC-3/STS-3 - STS-3c - STS-3c SPE - Bulk
 OC-192/OC-48/OC-12/OC-3/STS-3 - STS-3c - STS-3c SPE - E4
 OC-192/OC-48/OC-12/OC-3/STS-3 - STS-3c - STS-3c SPE - TU-3 - VC-3 - Bulk
 OC-192/OC-48/OC-12/OC-3/STS-3 - STS-3c - STS-3c SPE - TU-3 - VC-3 - DS3
 OC-192/OC-48/OC-12/OC-3/STS-3 - STS-3c - STS-3c SPE - TU-3 - VC-3 - E3
 OC-192/OC-48/OC-12/OC-3/STS-3
 - STS-3c - STS-3c SPE - VT-12 - VT-12 SPE - Bulk
 OC-192/OC-48/OC-12/OC-3/STS-3
 - STS-3c - STS-3c SPE - VT-12 - VT-12 SPE - E1 (Async/Sync)
 OC-192/OC-48/OC-12/OC-3/STS-3
 - STS-3c - STS-3c SPE - VT-11 - VT-11 SPE - Bulk
 OC-192/OC-48/OC-12/OC-3/STS-3
 - STS-3c - STS-3c SPE - VT-11 - VT-11 SPE - DS1 (Async/Sync)
 OC-192/OC-48/OC-12/OC-3/STS-3 - STS-1 - STS-1 SPE - Bulk
 OC-192/OC-48/OC-12/OC-3/STS-3 - STS-1 - STS-1 SPE - DS3
 OC-192/OC-48/OC-12/OC-3/STS-3 - STS-1 - STS-1 SPE - E3
 OC-192/OC-48/OC-12/OC-3/STS-3
 - STS-1 - STS-1 SPE - VT-12 - VT-12 SPE - Bulk
 OC-192/OC-48/OC-12/OC-3/STS-3
 - STS-1 - STS-1 SPE - VT-12 - VT-12 SPE - E1 (Async/Sync)
 OC-192/OC-48/OC-12/OC-3/STS-3
 - STS-1 - STS-1 SPE - VT-11 - VT-11 SPE - Bulk
 OC-192/OC-48/OC-12/OC-3/STS-3
 - STS-1 - STS-1 SPE - VT-11 - VT-11 SPE - DS1/J1 (Async/Sync)

Dummy channel handling Copy, Unequipped (For STS only)

Test patterns

- PRBS: 2⁹-1, 2¹¹-1, 2¹⁵-1, 2²⁰-1, 2²³-1, 2²⁹-1, 2³¹-1 (Normal/Inverse)
- Fixed :User Pattern, All0, All1, Alternating 1:1, Alternating 1:3, Alternating 1:7, 2 in 8
- User Pattern : 32 bit, 2048 bit

Preset data OH Preset data

- TOH : All bytes except B1, B2, H1, H2 and H3 byte
- STS-3c/STS-1 POH : All bytes except B3
- VT-2/VT-1.5 POH : All bytes except BIP-2

Path trace Setting: J0, J1, J2 (ASCII data, 16 bytes/64 bytes)

Tandem connection	Off, Z5(STS-3c), Z5(STS-1), Z6(VT-2), Z6(VT-1.5)
Frequency Offset	MU100010A: ± 50 ppm 1 ppm step MU100011A: ± 200 ppm 0.1 ppm step
Alarm Insertion	<p>Item</p> <ul style="list-style-type: none">• LOS, LOF, OOF, AIS-L, RDI-L, AIS-P, LOP-P, TIM-P, PLM-P, UNEQ-P, RDI-P, AIS-V, LOP-V, LOM-V, TIM-V, UNEQ-V, RDI-V, PLM-V, LSS, TC-UNEQ, TC-LTC, TC-TIM, TC-AIS, TC-RDI, TC-ODI <p>Insertion :</p> <ul style="list-style-type: none">• Permanent, Alternate (Excluding LOS, OOF and LSS)• Permanent (For LOS, OOF and LSS) <p>Alternate :</p> <ul style="list-style-type: none">• Alarm length : 1 to 8000 (Frame)• Normal length : 1 to 8000 (Frame)
Error Insertion	<p>Item</p> <ul style="list-style-type: none">• A1A2, B1, B2, REI-L, B3, REI-P, V5/B3, REI-V, TC-IEC, TC-REI, TC-OEI, TC-BIP-2, ERR-TRANS, Pattern error <p>Insertion :</p> <ul style="list-style-type: none">• Manual, Rate, Alternate (Excluding ERR-TRANS)• Manual, Rate (For ERR-TRANS) <p>Manual :</p> <ul style="list-style-type: none">• Burst length : 1 to 8000 (bit) (Excluding Pattern error)• Burst length : 1 to 4000 (bit) (For Pattern error) <p>Rate:</p> <ul style="list-style-type: none">• 1×10^{-3}, 1×10^{-4}, 1×10^{-5}, 1×10^{-6}, 1×10^{-7}, 1×10^{-8}, 1×10^{-9}, 1×10^{-10} The available highest rate varies depending on the error item. <p>Alternate :</p> <ul style="list-style-type: none">• (Excluding Pattern error)<ul style="list-style-type: none">◦ Error : 1 to 8000 (Frame)◦ Normal : 1 to 8000 (Frame)• (For Pattern error)<ul style="list-style-type: none">◦ Error : 1 to 4000 (bit)◦ Normal : 100 to 4000 (bit)
Pointer	STS-3c, STS-1, TU-3, VT-2, VT-1.5
	<p>Test Sequence :</p> <ul style="list-style-type: none">• No Test Sequence• Single Alternating• Regular + Double• Regular + Missing• Double Alternating

Movement :

- Positive
- Negative
- Burst: 1 to 100

Jump :

- NDF: Including NDF or Excluding NDF
- Pointer Value: 0 to 782(STS-3c/STS-1) or 764(TU-3) or 139(VT-2) or 103(VT-1.5)

Error/Alarm detection Alarm detection

- LOS, LOF, OOF, AIS-L, RDI-L, AIS-P, LOP-P, TIM-P, PLM-P, UNEQ-P, RDI-P, AIS-V, LOP-V, LOM-V, TIM-V, UNEQ-V, RDI-V, PLM-V, TC-UNEQ, TC-LTC, TC-TIM, TC-AIS, TC-RDI, TC-ODI, LSS

Display : Second (Resolution : 1 second)

Error Detection

- A1A2, B1, B2, REI-L, B3, REI-P, V5/B3, REI-V, TC-IEC, TC-BIP-2, TC-REI, TC-OEI, Pattern error, Pattern block error for G.826

Display : Count, Ratio

Monitor

Signal level:

- dBm (Excluding STS-3)
- dB (For STS-3)

Deviation: ppm (Resolution: 1ppm)

Bit rate: bit/s

Pointer analyze

Pointer value: STS-PTR, VT-PTR

Element : Negative, Positive

Graph : Pointer movement

OH Capture

Item

- TOH: 64 Frames
- POH: 64 Frames
- Pathtrace:J0/J1/J2 (Displays in ASCII characters)

Timing

- Single
- Repeat : Update period 1s

Transceiver

Module Present

Transceiver Information

Alarm, Wavelength and bit rate, Compliance, Vendor Information, Output Control

Power monitor

I2C analysis

For SFP and SFP+:
Memory A0h, Memory A2h, Read/Write

- Through Mode** Mode :
- Through Rx
 - OH Overwrite
 - TOH, A1/A2, K1/K2, S1, DCC1-3, DCC4-12, J0, TOH 1byte

Stimuli

- Alarm : LOS, LOF, OOF, RDI-L
Available alarms depend on Through mode setting.
- Error : A1A2, B1, B2, REI-L, ERR-TRANS
Available errors depend on Through mode setting.
- Insertion: refer to [Alarm Insertion](#) and [Error Insertion](#).

APS APS (Automatic Protection Switching) Measurement

- Reference event : LOS, LOF, OOF, AIS-L, RDI-L, APS Switchover, AIS-P, LOP-P, TIM-P, PLM-P, UNEQ-P, LOM-V, AIS-V, LOP-V, TIM-V, PLM-V, UNEQ-V, LSS, A1A2, B1, B2, REI-L, B3, V5, Patter errors
- Max reference duration: 0.000 to 10000.000 ms
- Result : Average switching time, Maximum switching time, Minimum switching time

APS Protocol analyze

- APS configuration :Ring or Linear
 - Ring : Short Path, Long Path
 - Linear : 1+1 architecture, 1:n architecture
- APS Protocol Request : The value of K1, K2 byte is sent depending on selected type.
- APS Interpretation : Number, Elapsed Time

Delay measurement Measurement Mode : Single, Repeat

Measurement Period : 0.5, 1, 2, 5,10 s

Measurement Range : Up to 10 000 000.000 μ s / resolution 0.1 μ s, Timeout

SONET Performance Measurement

- Setup : G826, G.828+G.829, M.2101.1(M2100)
- Allocation
 - Mux Allocation 0 to 100%
 - STS-3c Allocation 0 to 100%
 - STS-1 Allocation 0 to 100%
 - VT-2/VT-1.5/VC-12 Allocation 0 to 100%
- Time period : 15minutes, 1hour, 2hour, 24hour, 7days (only M.2101.1)
- Result : ES, SES, BBE, UNAV
- Display : Count, Ratio

Tributary Scan Displays the alarm status of all channels in a specified layer.
Green (No alarm), Red (Alarm occurring), Gray (Not applied)

12.5.2.3 PDH

Number of ports Max. 2

Frame format	<p>Non PCM frame Bit rate : Refer to Bit Rate.</p> <p>Framed Bit rate (Format)</p> <ul style="list-style-type: none"> • E1 2.048Mbit/s (30,31ch with or without CRC4, Sa-bit, CAS) • E3 34.368Mbit/s (G.751) • E4 139.264Mbit/s (G.751) • DS1 1.544Mbit/s (T1.107, SF/ESF/Japan ESF, CAS) • DS3 44.736Mbit/s (T1.107, M13/C-bit) <p>Mux/DeMux</p> <ul style="list-style-type: none"> • E1 n*64kbit/s • DS1 n*64kbit/s or n*56kbit/s
Frequency Offset	±125 ppm 1 ppm step
BER Test patterns	<p>PRBS:</p> <p>E1 $2^6-1, 2^7-1, 2^9-1, 2^{11}-1, 2^{15}-1, 2^{20}-1, 2^{23}-1$, QRSS 11, QRSS 20</p> <p>E3/E4 $2^9-1, 2^{11}-1, 2^{15}-1, 2^{20}-1, 2^{23}-1, 2^{29}-1, 2^{31}-1$, QRSS 20 (2²⁹-1, 2³¹-1 and QRSS 20 are only available for E4.)</p> <p>DS1/DS3 $2^9-1, 2^{11}-1, 2^{15}-1, 2^{20}-1, 2^{23}-1, 2^{29}-1, 2^{31}-1$, QRSS 20</p> <p>Fixed : User Pattern (32bis, 2048bits), All0, All1, 1 in 1, 1 in 3, 1 in 7, 3 in 24, Fox Pattern (Fox Pattern is not available for E4.)</p> <p>Logic : Normal, Inverse</p>
Line build out	<p>DS1 0 dB, -7.5 dB, -15 dB, -22.5dB, 1-133 ft, 133-266 ft, 266-399 ft, 399-533 ft, 533-655 ft</p> <p>DS3 High-0 ft, DSX-450 ft</p>
Alarm Insertion	<p>Item</p> <p>E1 No Signal, AIS, No Frame, Distant Alarm, Pattern sync loss, No CAS MFAS, Distant MF Alarm</p> <p>E3/E4 No Signal, AIS, No Frame, RDI, Pattern sync loss</p> <p>DS1 LOS, AIS, RAI, OOF, LLS</p> <p>DS3 LOS, AIS, RAI, LOF, Idle, LSS</p>
Error Insertion	<p>Item</p> <p>E1</p>

FAS, FAS and NFAS, FAS word, CRC4, CRC4 MFAS, Code, Pattern error, CAS MFAS, E-Bit, Pattern slip, Frame slip, Transparent

E3/E4

Frame, Code, Pattern error, Pattern slip (Code is only available for E3.)

DS1

Pattern error, Pattern slip, CRC-6, F-Bit, S-Bit, BPV, EXZ

DS3

Pattern error, Pattern slip, FEBE, C-Bit, F-Bit, P-Bit, BPV

Timing : Manual, Burst

Error/Alarm detection Alarm detection

E1

LOS, AIS, No Frame, No CRC4 MF, Distant, No sync, No CAS MF, Distant MF

E3/E4

LOS, AIS, No Frame, Distant, No Sync

DS1

LOS, AIS, OOF, RAI, LLS

DS3

LOS, AIS, LOF, RAI, IDLE, LSS

Display : Second

Error Detection

E1

FAS, Pattern error, CRC4, CRC4 MFAS, E-bit, Code, Pattern slip, Frame slip, Pattern block error for G.826

E3/E4

FAS, Code, Pattern error, Pattern slip, Pattern block error for G.826 (Code is only available for E3.)

DS1

F-Bit, Pattern, CRC-6, S-Bit, BPV, Pattern slip, EXZ, Pattern block error for G.826

DS3

BPV, Pattern error, Pattern slips, Parity, C-bit, F-bit, FEBE, Pattern block error for G.826

Display : Count, Ration

Error Performance G.821/G.826/M.2100 analysis of the received signal

Result

Status

Current information on:

- Alarms and errors
- Input level indication
- Actual bit rate
- Frequency deviation
- E1: CAS bits, FAS/non FAS bits
- DS1: CAS bits, F-Bit, S-Bit
- DS3: F-bits
- Round trip delay

- APS switching time (Only available in case of E1 or DS1.)

12.5.3 OTN

12.5.3.1 OTN Setup

Frame Format	OTU4, OTU3, OTU3e1, OTU3e2, OTU2, OTU1e, OTU2e, OTU1f, OTU2f, OTU1
Transmitter Clock	Reference Clock <ul style="list-style-type: none"> • Internal clock • External clock <ul style="list-style-type: none"> ◦ BITS ◦ SETS ◦ 2MHz ◦ 10MHz • GPS • Received
Through mode	Transparent, OH Overwrite Thr. (ALL OTU/ODU/OPU OH)
Mapping	<p>OTU4 (Client PRBS)</p> <p>OTU4-ODU4/OPU4-PRBS OTU4-ODU4/OPU4-ODTU4.1-ODU0/OPU0-PRBS OTU4-ODU4/OPU4-ODTU4.2-ODU1/OPU1-PRBS OTU4-ODU4/OPU4-ODTU4.2-ODU1/OPU1-ODTU01-ODU0/OPU0-PRBS OTU4-ODU4/OPU4-ODTU4.8(ODU2)-ODU2/OPU2-PRBS OTU4-ODU4/OPU4-ODTU4.8(ODU2)-ODU2/OPU2-ODTU2.1 -ODU0/OPU0-PRBS OTU4-ODU4/OPU4-ODTU4.8(ODU2)-ODU2/OPU2 -ODTU12(PT=20,21)-ODU1/OPU1-PRBS OTU4-ODU4/OPU4-ODTU4.8(ODU2)-ODU2/OPU2 -ODTU12(PT=20,21)-ODU1/OPU1-ODTU01-ODU0/OPU0-PRBS OTU4-ODU4/OPU4-ODTU4.8(ODU2e)-ODU2e/OPU2e-PRBS</p> <p>OTU4 (Client Null)</p> <p>OTU4-ODU4/OPU4-NULL OTU4-ODU4/OPU4-ODTU4.1-ODU0/OPU0-NULL OTU4-ODU4/OPU4-ODTU4.2-ODU1/OPU1-NULL OTU4-ODU4/OPU4-ODTU4.2-ODU1/OPU1-ODTU01-ODU0/OPU0-NULL OTU4-ODU4/OPU4-ODTU4.8(ODU2)-ODU2/OPU2-NULL OTU4-ODU4/OPU4-ODTU4.8(ODU2)-ODU2/OPU2-ODTU2.1 -ODU0/OPU0-NULL OTU4-ODU4/OPU4-ODTU4.8(ODU2)-ODU2/OPU2 -ODTU12(PT=20,21)-ODU1/OPU1-NULL OTU4-ODU4/OPU4-ODTU4.8(ODU2)-ODU2/OPU2 -ODTU12(PT=20,21)-ODU1/OPU1-ODTU01-ODU0/OPU0-NULL OTU4-ODU4/OPU4-ODTU4.8(ODU2e)-ODU2e/OPU2e-NULL</p> <p>OTU4 (Client Ethernet)</p> <p>OTU4-ODU4/OPU4-100GbE OTU4-ODU4/OPU4-ODTU4.8(ODU2)-ODU2/OPU2-10GbE</p>

OTU4-ODU4/OPU4-ODTU4.8(ODU2)-ODU2/Ext.OPU2-10GbE
OTU4-ODU4/OPU4-ODTU4.8(ODU2e)-ODU2e/OPU2e-10GbE
OTU4-ODU4/OPU4-ODTU4.8(ODU2)-ODU2/OPU2
-ODTU12(PT=20,21)-ODU1/OPU1-ODTU01-ODU0/OPU0-GbE
OTU4-ODU4/OPU4-ODTU4.1-ODU0/OPU0-GbE
OTU4-ODU4/OPU4-ODTU4.2-ODU1/OPU1-ODTU01-ODU0/OPU0-GbE

OTU4 (Client SDH/SONET)

OTU4-ODU4/OPU4-ODTU4.8(ODU2)-ODU2/OPU2
-STM64(Async)/STS192(Async)
OTU4-ODU4/OPU4-ODTU4.8(ODU2)-ODU2/OPU2
-STM64(Sync)/STS192(Sync)
OTU4-ODU4/OPU4-ODTU4.2-ODU1/OPU1-STM16(Async)/STS48(Async)
OTU4-ODU4/OPU4-ODTU4.2-ODU1/OPU1-STM16(Async)/STS48(Sync)
OTU4-ODU4/OPU4-ODTU4.8(ODU2)-ODU2/OPU2
-ODTU12(PT=20,21)-ODU1/OPU1-STM16(Async)/STS48(Async)
OTU4-ODU4/OPU4-ODTU4.8(ODU2)-ODU2/OPU2
-ODTU12(PT=20,21)-ODU1/OPU1-STM16(Async)/STS48(Sync)
OTU4-ODU4/OPU4-ODTU4.1-ODU0/OPU0-STM4/STS12
OTU4-ODU4/OPU4-ODTU4.2-ODU1/OPU1
-ODTU01-ODU0/OPU0-STM4/STS12
OTU4-ODU4/OPU4-ODTU4.8(ODU2)-ODU2/OPU2
-ODTU12(PT=20,21)-ODU1/OPU1-ODTU01-ODU0/OPU0-STM4/STS12
OTU4-ODU4/OPU4-ODTU4.1-ODU0/OPU0-STM1/STS3
OTU4-ODU4/OPU4-ODTU4.2-ODU1/OPU1-ODTU01-ODU0/OPU0-
STM1/STS3
OTU4-ODU4/OPU4-ODTU4.8(ODU2)-ODU2/OPU2
-ODTU12(PT=20,21)-ODU1/OPU1-ODTU01-ODU0/OPU0-STM1/STS3
OTU4-ODU4/OPU4-ODTU4.1-ODU0/OPU0-PRBS
OTU4-ODU4/OPU4-ODTU4.2-ODU1/OPU1-PRBS
OTU4-ODU4/OPU4-ODTU4.8(ODU2)-ODU2/OPU2-PRBS
OTU4-ODU4/OPU4-ODTU4.1-ODU0/OPU0-NULL
OTU4-ODU4/OPU4-ODTU4.2-ODU1/OPU1-NULL
OTU4-ODU4/OPU4-ODTU4.8(ODU2)-ODU2/OPU2-NULL

OTU4 (Client FC)

OTU4-ODU4/OPU4-ODTU4.8(ODU2e)-ODU2e/OPU2e-FC1200
OTU4-ODU4/OPU4-ODTU4.2-ODU1/OPU1-FC200
OTU4-ODU4/OPU4-ODTU4.8(ODU2)-ODU2/OPU2
-ODTU12(PT=20,21)-ODU1/OPU1-FC200
OTU4-ODU4/OPU4-ODTU4.1-ODU0/OPU0-FC100
OTU4-ODU4/OPU4-ODTU4.2-ODU1/OPU1-ODTU01-ODU0/OPU0-FC100
OTU4-ODU4/OPU4-ODTU4.8(ODU2)-ODU2/OPU2
-ODTU12(PT=20,21)-ODU1/OPU1-ODTU01-ODU0/OPU0-FC100
OTU4-ODU4/OPU4-ODTU4.8(ODU2)-ODU2/OPU2
-ODTU2.1-ODU0/OPU0-FC100

OTU4 (Client CPRI)

OTU4-ODU4/OPU4-ODTU4.2-ODU1/OPU1-2457.6 M(CPRI)
OTU4-ODU4/OPU4-ODTU4.8(ODU2)-ODU2/OPU2
-ODTU12(PT=20,21)-ODU1/OPU1-2457.6 M(CPRI)

OTU4-ODU4/OPU4-ODTU4.1-ODU0/OPU0-1228.8 M(CPRI)
OTU4-ODU4/OPU4-ODTU4.2-ODU1/OPU1-ODTU01-ODU0/OPU0-1228.8
M(CPRI)
OTU4-ODU4/OPU4-ODTU4.8(ODU2)-ODU2/OPU2
-ODTU2.1-ODU0/OPU0-1228.8 M(CPRI)
OTU4-ODU4/OPU4-ODTU4.8(ODU2)-ODU2/OPU2
-ODTU12(PT=20,21)-ODU1/OPU1-ODTU01-ODU0/OPU0-1228.8 M(CPRI)
OTU4-ODU4/OPU4-ODTU4.1-ODU0/OPU0-614.4 M(CPRI)
OTU4-ODU4/OPU4-ODTU4.2-ODU1/OPU1-ODTU01-ODU0/OPU0-614.4
M(CPRI)
OTU4-ODU4/OPU4-ODTU4.8(ODU2)-ODU2/OPU2
-ODTU2.1-ODU0/OPU0-614.4 M(CPRI)
OTU4-ODU4/OPU4-ODTU4.8(ODU2)-ODU2/OPU2
-ODTU12(PT=20,21)-ODU1/OPU1-ODTU01-ODU0/OPU0-614.4 M(CPRI)

OTU3/3e1/3e2 (Client PRBS)

OTU3-ODU3/OPU3-PRBS
OTU3-ODU3/OPU3-ODTU13(PT=20,21)-ODU1/OPU1-PRBS
OTU3-ODU3/OPU3-ODTU13(PT=20,21)-ODU1/OPU1
-ODTU01-ODU0/OPU0-PRBS
OTU3-ODU3/OPU3-ODTU23(PT=20,21)-ODU2/OPU2-PRBS
OTU3-ODU3/OPU3-ODTU23(PT=20,21)-ODU2/OPU2
-ODTU2.1-ODU0/OPU0-PRBS
OTU3-ODU3/OPU3-ODTU23(PT=20,21)-ODU2/OPU2
-ODTU12(PT=20,21)-ODU1/OPU1-PRBS
OTU3-ODU3/OPU3-ODTU23(PT=20,21)-ODU2/OPU2
-ODTU12(PT=20,21)-ODU1/OPU1-ODTU01-ODU0/OPU0-PRBS
OTU3-ODU3/OPU3-ODTU3.1-ODU0/OPU0-PRBS
OTU3e1-ODU3e1/OPU3e1-ODTU2e3e1-ODU2e/OPU2e-PRBS
OTU3e2-ODU3e2/OPU3e2-ODTU3e2.8-ODU2e/OPU2e-PRBS

OTU3/3e1/3e2 (Client Null)

OTU3-ODU3/OPU3-NULL
OTU3-ODU3/OPU3-ODTU13(PT=20,21)-ODU1/OPU1-NULL
OTU3-ODU3/OPU3-ODTU13(PT=20,21)-ODU1/OPU1
-ODTU01-ODU0/OPU0-NULL
OTU3-ODU3/OPU3-ODTU23(PT=20,21)-ODU2/OPU2-NULL
OTU3-ODU3/OPU3-ODTU23(PT=20,21)-ODU2/OPU2
-ODTU2.1-ODU0/OPU0-NULL
OTU3-ODU3/OPU3-ODTU23(PT=20,21)-ODU2/OPU2
-ODTU12(PT=20,21)-ODU1/OPU1-NULL
OTU3-ODU3/OPU3-ODTU23(PT=20,21)-ODU2/OPU2
-ODTU12(PT=20,21)-ODU1/OPU1-ODTU01-ODU0/OPU0-NULL
OTU3-ODU3/OPU3-ODTU3.1-ODU0/OPU0-NULL
OTU3e1-ODU3e1/OPU3e1-ODTU2e3e1-ODU2e/OPU2e-NULL
OTU3e2-ODU3e2/OPU3e2-ODTU3e2.8-ODU2e/OPU2e-NULL

OTU3/3e1/3e2 (Client Ethernet)

OTU3-ODU3/OPU3-40GbE
OTU3-ODU3/OPU3-ODTU13(PT=20,21)-ODU1/OPU1
-ODTU01-ODU0/OPU0-GbE

OTU3-ODU3/OPU3-ODTU23(PT=20,21)-ODU2/OPU2
-ODTU12(PT=20,21)-ODU1/OPU1-ODTU01-ODU0/OPU0-GbE
OTU3-ODU3/OPU3-ODTU3.1-ODU0/OPU0-GbE
OTU3-ODU3/OPU3-ODTU23(PT=20,21)-ODU2/OPU2-10GbE
OTU3-ODU3/OPU3-ODTU23(PT=20,21)-ODU2/Ext.OPU2-10GbE
OTU3e1-ODU3e1/OPU3e1-ODTU2e3e1-ODU2e/OPU2e-10GbE

OTU3 (Client SDH/SONET)

OTU3-ODU3/OPU3-STM256(Async)/STS768(Async)
OTU3-ODU3/OPU3-ODTU23(PT=20,21)-ODU2/OPU2
-STM64(Async)/STS192(Async)
OTU3-ODU3/OPU3-ODTU13(PT=20,21)-ODU1/OPU1
-STM16(Async)/STS48(Async)
OTU3-ODU3/OPU3-ODTU3.1-ODU0/OPU0-STM4/STS12
OTU3-ODU3/OPU3-ODTU3.1-ODU0/OPU0-STM1/STS3
OTU3-ODU3/OPU3-PRBS
OTU3-ODU3/OPU3-ODTU23(PT=20,21)-ODU2/OPU2-PRBS
OTU3-ODU3/OPU3-ODTU13(PT=20,21)-ODU1/OPU1-PRBS
OTU3-ODU3/OPU3-ODTU3.1-ODU0/OPU0-PRBS
OTU3-ODU3/OPU3-NULL
OTU3-ODU3/OPU3-ODTU23(PT=20,21)-ODU2/OPU2-NULL
OTU3-ODU3/OPU3-ODTU13(PT=20,21)-ODU1/OPU1-NULL
OTU3-ODU3/OPU3-ODTU3.1-ODU0/OPU0-NULL

OTU3 (Client FC)

OTU3-ODU3/OPU3-ODTU13(PT20,21)-ODU1/OPU1-FC200
OTU3-ODU3/OPU3-ODTU23(PT=20,21)-ODU2/OPU2
-ODTU12(PT=20,21)-ODU1/OPU1-FC200
OTU3-ODU3/OPU3-ODTU13(PT=20,21)-ODU1/OPU1
-ODTU01-ODU0/OPU0-FC100
OTU3-ODU3/OPU3-ODTU23(PT=20,21)-ODU2/OPU2
-ODTU12(PT=20,21)-ODU1/OPU1-ODTU01-ODU0/OPU0-FC100
OTU3-ODU3/OPU3-ODTU3.1-ODU0/OPU0-FC100

OTU3 (Client CPRI)

OTU3-ODU3/OPU3-ODTU13(PT20,21)-ODU1/OPU1-2457.6 M(CPRI)
OTU3-ODU3/OPU3-ODTU23(PT=20,21)-ODU2/OPU2
-ODTU12(PT=20,21)-ODU1/OPU1-2457.6 M(CPRI)
OTU3-ODU3/OPU3-ODTU3.1-ODU0/OPU0-1228.8 M(CPRI)
OTU3-ODU3/OPU3-ODTU13(PT=20,21)-ODU1/OPU1
-ODTU01-ODU0/OPU0-1228.8 M(CPRI)
OTU3-ODU3/OPU3-ODTU23(PT=20,21)-ODU2/OPU2
-ODTU12(PT=20,21)-ODU1/OPU1-ODTU01-ODU0/OPU0-1228.8 M(CPRI)
OTU3-ODU3/OPU3-ODTU3.1-ODU0/OPU0-614.4 M(CPRI)
OTU3-ODU3/OPU3-ODTU13(PT=20,21)-ODU1/OPU1
-ODTU01-ODU0/OPU0-614.4 M(CPRI)
OTU3-ODU3/OPU3-ODTU23(PT=20,21)-ODU2/OPU2
-ODTU12(PT=20,21)-ODU1/OPU1-ODTU01-ODU0/OPU0-614.4 M(CPRI)
OTU3-ODU3/OPU3-ODTU23(PT=20,21)-ODU2/OPU2
-ODTU2.1-ODU0/OPU0-614.4 M(CPRI)

-ODTU01-ODU0/OPU0-FC100

OTU2-ODU2/OPU2-ODTU2.1-ODU0/OPU0-FC100

OTU2 (Client CPRI)

OTU2-ODU2/OPU2-ODTU2.ts-ODUflex-9830.4 M(CPRI)

OTU2-ODU2/OPU2-ODTU2.ts-ODUflex-6144.0 M(CPRI)

OTU2-ODU2/OPU2-ODTU2.ts-ODUflex-4915.2 M(CPRI)

OTU2-ODU2/OPU2-ODTU2.ts-ODUflex-3072.0 M(CPRI)

OTU2-ODU2/OPU2-ODTU12(PT=20,21)-ODU1/OPU1-2457.6 M(CPRI)

OTU2-ODU2/OPU2-ODTU12(PT=20,21)-ODU1/OPU1

-ODTU01-ODU0/OPU0-1228.8 M(CPRI)

OTU2-ODU2/OPU2-ODTU2.1-ODU0/OPU0-1228.8 M(CPRI)

OTU2-ODU2/OPU2-ODTU12(PT=20,21)-ODU1/OPU1

-ODTU01-ODU0/OPU0-614.4 M(CPRI)

OTU2-ODU2/OPU2-ODTU2.1-ODU0/OPU0-614.4 M(CPRI)

OTU1 (Client PRBS)

OTU1-ODU1/OPU1-PRBS

OTU1-ODU1/OPU1-ODTU01-ODU0/OPU0-PRBS

OTU1 (Client Null)

OTU1-ODU1/OPU1-NULL

OTU1-ODU1/OPU1-ODTU01-ODU0/OPU0-NULL

OTU1 (Client Ethernet)

OTU1-ODU1/OPU1-ODTU01-ODU0/OPU0-GbE

OTU1 (Client SDH/SONET)

OTU1-ODU1/OPU1-STM16(Async)/STS48(Async)

OTU1-ODU1/OPU1-ODTU01-ODU0/OPU0-STM4/STS12

OTU1-ODU1/OPU1-ODTU01-ODU0/OPU0-STM1/STS3

OTU1-ODU1/OPU1-PRBS

OTU1-ODU1/OPU1-ODTU01-ODU0/OPU0-PRBS

OTU1-ODU1/OPU1-ODTU01-ODU0/OPU0-NULL

OTU1 (Client FC)

OTU1-ODU1/OPU1-FC200

OTU1-ODU1/OPU1-ODTU01-ODU0/OPU0-FC100

OTU1 (Client CPRI)

OTU1-ODU1/OPU1-2457.6 M(CPRI)

OTU1-ODU1/OPU1-ODTU01-ODU0/OPU0-1228.8 M(CPRI)

OTU1-ODU1/OPU1-ODTU01-ODU0/OPU0-614.4 M(CPRI)

OTU1e/2e (Client PRBS)

OTU1e-ODU1e/OPU1e-PRBS

OTU2e-ODU2e/OPU2e-PRBS

OTU1e/2e (Client Null)

OTU1e-ODU1e/OPU1e-NULL
OTU2e-ODU2e/OPU2e-NULL

OTU1e/2e (Client Ethernet)

OTU1e-ODU1e/OPU1e-10GbE
OTU2e-ODU2e/OPU2e-10GbE

OTU2e (Client FC)

OTU2e-ODU2e/OPU2e-FC1200

OTU1f/2f (Client PRBS)

OTU1f-ODU1f/OPU1f-PRBS
OTU2f-ODU2f/OPU2f-PRBS

OTU1f/2f (Client Null)

OTU1f-ODU1f/OPU1f-NULL
OTU2f-ODU2f/OPU2f-NULL

OTU1f/2f (Client FC)

OTU1f-ODU1f/OPU1f-FC1200
OTU2f-ODU2f/OPU2f-FC1200

Client Signals	Client Signals Refer to Section SDH/SONET, Ethernet, Fibre Channel and CPRI.
Test Pattern	PRBS : 2^9-1 , $2^{11}-1$, $2^{15}-1$, $2^{20}-1$, $2^{23}-1$, $2^{29}-1$, $2^{31}-1$ with polarization Normal / Inverted User Pattern : 32bits, 2048bits
Measurement channel	Dummy (Unused), Copy Tributary Port and Slot can be configured in ODTU mapping.
FEC Encode/Decode	RS(255,239) described in ITU-T Rec. G709, No FEC
OH Edit	All OTU, ODU bytes except MFAS and BIP8 TTI, FTFL bytes with multi-frame manner
TTI measurement	Condition for detecting TIM can be selected. TCM measurement On/Off
MSIM Detection	Expected MSI bytes are set from Tx Data or Received Data.

12.5.3.2 OTN Stimuli

Alarm Insertion	OTL * OOE/LOF, OOR/LOR OTU, ODU * LOS, OTU-AIS, OOF/LOF, OOM/LOM, SM-TIM, SM-BIAE, SM-BDI, SM-IAE, ODU-AIS, ODU-OCI, ODU-LCK, PM-TIM, PM-BDI, FSF, FSD, BSF, BSD,
------------------------	---

TCMi-TIM, TCMi-BIAE, TCMi-BDI, TCMi-IAE, TCMi-LTC (i=1-6)
 Multiplexed ODU
 OOF/LOF, OOM/LOM, ODU-AIS, ODU-OCI, ODU-LCK, PM-TIM, PM-BDI,
 FSF, FSD, BSF, BSD
 Client
 Client-AIS, CSF
 Insertion timing
 Single, Burst, Alternate, All

*: Available for both of Normal mode and Through mode

Error Insertion

OTL *
 MFAS, LLM
 OTU, ODU *
 Bitall, FAS, MFAS, SM-BIP8, SM-BEI, PM-BIP8, PM-BEI, TCMi-BIP8, TCMi-
 BEI (i=1-6), Uncorrectable Error, Correctable Error
 Multiplexed ODU
 FAS, PM-BIP8, PM-BEI
 GMP
 CRC8, CRC5, Invalid JC1, Invalid JC2, Invalid JC1&JC2
 GFP
 cHEC, tHEC, Superblock CRC, eHEC, FCS, CMF
 Inserted Error bits are editable.
 Client
 Bit Error
 Insertion timing
 Single, Burst, Alternate, Rate, Rate (Random for Bitall), All

*: Available for both of Normal mode and Through mode

Frequency Offset

MU100010A: ± 50 ppm 1 ppm step
 MU100011A: ± 200 ppm 0.1 ppm step

Payload Offset

Movement type
 AMP
 Burst Insertion (Positive(+1), Positive(+2), Negative (-1))
 GMP
 Offset (ppm)
 Offset
 AMP
 -131 ppm to +83 ppm (Depending on mapping configuration)
 0.1 ppm step
 GMP
 -150 ppm to +150 ppm 0.1 ppm step

12.5.3.3 OTN Measurement

Alarm Detection

OTL
 LOF, OOF, LOR, OOR, ILA/OLA
 OTU, ODU
 LOS, OTU-AIS, LOF, OOF, LOM, OOM, SM-TIM, SM-BIAE, SM-BDI, SM-IAE,
 ODU-AIS, ODU-OCI, ODU-LCK, PM-TIM, PM-BDI, FSF, FSD, BSF, BSD, MSIM,
 TCMi-TIM, TCMi-BIAE, TCMi-BDI, TCMi-IAE, TCMi-LTC (i=1-6)

	Multiplexed ODU LOFLOM, OOF, OOM, ODU-AIS, ODU-OCI, ODU-LCK, PM-TIM, PM-BDI, MSIM
	Client Client-AIS, PLM, CSF, LSS
Error Detection	OTL FAS, MFAS, LLM
	OTU, ODU FAS, MFAS, SM-BIP8, SM-BEI, FEC Corrected, FEC Uncorrectable, PM-BIP8, PM-BEI, TCMi-BIP8, TCMi-BEI (i=1-6)
	Multiplexed ODU FAS, MFAS, PM-BIP8, PM-BEI
	GFP cHEC corrected, cHEC uncorrectable, tHEC corrected, tHEC uncorrectable, CSF Signal, CSF Sync, Invalid GFP Frame, Superblock CRC, eHEC corrected, eHEC uncorrectable, FCS, CMF Sync, CMF Signal, SSF, PTI Mismatch, UPI Mismatch
	Client Bit Error
Justification analysis	Count
	AMP Positive(+1), Positive(+2), Negative (-1), offset(ppm)
	GMP CRC8 Error, CRC5 Error, Inc, Inc>1, Inc>2, Inc Over, Dec, Dec>1, Dec>2, Dec Over, offset(ppm), Cm(t) Max, Cm(t) Min
OH Capture	OTU/ODU/OPU OH, Multiplexed ODU/OPU OH TTI bytes, FTFL bytes with Multi-frame Manner
	Update timing Repeat 1sec, Single
Transceiver	Module Present Transceiver Information Alarm, Wavelength and bit rate, Compliance, Vendor Information, Output Control
	Power monitor
	MDIO analysis For CFP4: NVR1, NVR2, Module FAWS, MW Lane FAWS, CTRL, MDIO Read/Write
	I2C analysis For QSFP+ and QSFP28: Lower, Lower (Lane), Upper (00), Upper (03), Read/Write
	Setting VOD, Pre, Post, DFE
APS Measurement	Result : Average switching time, Maximum switching time, Minimum switching time

Trigger
Start Trigger, Stop Trigger
Measurement Range
0.001 to 10.000 ms
Error Free Period
1, 10, 100, 200, 300, 400, 500, 600, 700, 800, 900 and 1000 ms

OTN Performance Measurement Standard
ITU-T Rec. G.8201, M.2401(M.2110)

Tributary Scan Supports up to 10 Gbps.

Detected Alarms
OTU-AIS, LOF, OOF, LOM, OOM, SM-BIAE, SM-BDI, SM-IAE, ODU-AIS, ODU-OCI, ODU-LCK, PM-BDI, LOFLOM

Round Trip Delay Result : RTD Time

Measurement Range
0.5sec, 1sec, 2sec, 5sec, 10sec
Measurement Timing
Single, Repeat

12.5.4 Fibre Channel

Port mode Off, FC100, FC200, FC400, FC800, FC1200, FC1600
Topology Point to Point, Fabric, E-Port
Framing SOF:Data:EOF, SOF:Header:Data:CRC:EOF
Content FOX, ALL5555, PRBS 9, PRBS 11, PRBS 15, PRBS 20, PRBS 23, PRBS 29, PRBS 31, BHFTEST, BCRPAT, BJTPAT, BSPAT, USER_32, ZERO
Alarm Insertion Item
Link reset, Link reset response, Not optional, Offline
Error Insertion Item
Bit, Symbol, Block, R_RDY, CRC
Insertion timing
Manual, Burst
Link Detection Signal Present, Sync Acquired, Link Status
Login Detection Fabric Login, Port Login, ELP
Pattern Detection Traffic, Pattern Sync, Pattern Error
Transceiver Module Present
Transceiver Information
Alarm, Wavelength and bit rate, Compliance, Vendor Information, Output Control
Power monitor
BER Test BERT:
Pattern bit count, Pattern errors, Frame loss, Frame loss seconds, Pattern loss seconds, Jitter, Latency, Service disruption

Symbol Errors
 Ordered Sets:
 R_RDY, LR, LRR, NOS, OLS
 Traffic:
 Frames, Bytes
 Errors:
 IFG, CRC, Symbol, CRD, Terminate, Errored
 Line rate, Frame rate, Throughput
 Size Distribution

Performance Test Mode:
 Port to Port, Loopback
 Test:
 Throughput, Traffic Profile, Latency, Burst, Credit (Only for Loopback mode)

Reflector mode Supports Reflector application.

12.5.5 CPRI/OBSAI

Port mode Unframed: Off, Normal
 CPRI Link: Off, Normal, Through
 OBSAI Link: Off, Normal

Line rate CPRI: 614.4 Mbps, 1228.8 Mbps, 2457.6 Mbps, 3072.0 Mbps, 4915.2 Mbps,
 6144.0 Mbps, 9830.4 Mbps, 10137.6 Mbps, 12165.12 Mbps, 24330.24 Mbps
 OBSAI: 768 Mbps, 1536 Mbps, 3072.0 Mbps, 6144.0 Mbps

Clock Configuration Timing Source

- Internal clock
- External clock
- GPS
- Received clock

Content Unframed, CPRI Link, OBSAI Link

Pattern PRBS 15, PRBS 20, PRBS 23, PRBS 29, PRBS 31, User 32 bit, OFF

CPRI Link Start up
 Enabled, Disabled
 Role
 Master, Slave
 Protocol version
 1, 2
 HDLC rate
 no HDLC, 240 kbit/s, 480 kbit/s, 960 kbit/s, 1920 kbit/s, 2400 kbit/s, Highest possible
 Ethernet
 On, Off
 Pointer: 20 to 63

OBSAI Link Force idle
 Off, IDLE_REQ, IDLE_ACK
 Scrambler seed index
 0 to 17

RP3 address
0000 to 1FFF
RP3 type
WCDMA/FDD, GSM/EDGE, 802.16, LTE
Forced scrambler seed, Rx filter
Available

Alarm Insertion Item
Unframed: Signal loss, LSS
CPRI Link: Signal loss, LOS, LOF, LSS, Remote-LOS, Remote-LOF, RAI, SDI, Reset
OBSAI Link: Signal loss, LOF, LSS

Error Insertion Item
Unframed: Pattern error
CPRI Link: LCV, SHV, K30.7, Pattern error
OBSAI Link: LCV, K30.7, Pattern error
Insertion timing
Manual, Rate

Frequency Offset ± 100 ppm 1 ppm step

Alarm Detection Unframed: Signal loss, LSS
CPRI Link: Signal loss, LOS, LOF, LSS
OBSAI Link: Signal loss, LOF, No message, LSS

Error Detection Unframed: Pattern error
CPRI Link: LCV, SHV, K30.7, Pattern error
OBSAI Link: LCV, K30.7, Pattern error

Remote status CPRI Link: Remote LOS, Remote LOF, RAI, SDI, Reset

Link CPRI Link:
Rx/Tx: Protocol version, HDLC rate, Pointer P
OBSAI Link:
Tx state, Rx state

Transceiver Module Present
Transceiver Information
Alarm, Wavelength and bit rate, Compliance, Vendor Information, Output Control
Power monitor

BER Test Alarm:
Unframed: Signal loss, LSS
CPRI Link: Signal loss, LOS, LOF, LSS, Remote LOS, Remote LOF, RAI, SDI, Reset
OBSAI Link: Signal loss, LOF, No message, LSS
Errors:
Unframed: Pattern error
CPRI Link: LCV, SHV, K30.7, Pattern error
OBSAI Link: LCV, K30.7, Pattern error
Frames count:
CPRI Link: Rx hyper frames, Rx code words, Tx hyper frames, Tx code words
OBSAI Link: Rx Message Groups, Tx Message Groups

Delay
 Delay, Average Delay, Min Delay, Max Delay, Measurement count
 APS
 Switching Time

CPRI Pass Through Alarm:
 Signal loss, LOS, LOF, Remote LOS, Remote LOF, RAI, SDI, Reset
 Errors:
 LCV, SHV, K30.7
 Frames count:
 Rx hyper frames, Rx code words, Tx hyper frames, Tx code words

12.5.6 Device Test

Interface Type Off, QSFP+, SFP28, CFP4, QSFP28

Bit Rate Off, 40G Ethernet, 100G Ethernet, STM256/OC768, OTU3, OTU3e1, OTU3e2, OTU4

Timing source

- Internal clock
- External clock

Test Pattern PRBS 7, PRBS 9, PRBS 15, PRBS 23, PRBS 31, Square Wave

Frequency Offset ±200 ppm 0.1 ppm step

Error Insertion

Item

- Bit Error

Insertion timing

- Single

Monitor

Signal level: dBm

Frequency: Hz, ppm

LOS, LSS, CDR Lock, Bit error

Transceiver

Module Present

Transceiver Information

- Alarm, Wavelength and bit rate, Compliance, Vendor Information, Output Control

Power monitor

MDIO analysis

- For CFP4:
 NVR1, NVR2, Module FAWS, MW Lane FAWS, CTRL, MDIO Read/Write

I2C analysis

- For QSFP+ and QSFP28:
 Lower, Lower (Lane), Upper (00), Upper (03), Read/Write
- For SFP and SFP28:
 Memory A0h, Memory A2h, Read/Write

Setting

- VOD, Pre, Post, DFE

**No Frame
Measurements**

Bit Error, Frequency

12.6 Optical Modules

Up to 2 optical modules can be installed.



Correct functionality can only be guaranteed with optical modules purchased from Anritsu for the MU100010A and MU100011A.

Safety measures for laser products

Optical modules for the MU100010A and MU100011A comply with optical safety standards in IEC 60825-1.

Specifications

Specification of optical modules purchased from Anritsu for the MU100010A and MU100011A (each with 1 transmitter and 1 receiver) with LC connectors (subject to change without further notice):

Order No./ Name	Description (Approx. Distance)	Min. Input Sensitivity	Input Wavelength	Output Power	Output Wavelength
G0311A * 1G 850 nm SX SFP	1000BASE - SX 850 nm Multi mode (0.5 km)	-17 dBm	770 to 860 nm	-9.5 to -3 dBm	830 to 860 nm
G0312A * 1G 1310 nm LX SFP	1000BASE - LX 1310 nm Single mode (10 km)	-18 dBm	1260 to 1580 nm	-10 to -3 dBm	1260 to 1360 nm
G0313A * 1G 1550 nm ZX SFP	1000BASE - ZX 1550 nm Single mode (80 km)	-23 dBm	1260 to 1580 nm	-2 to 5 dBm	1480 to 1580 nm
G0315A 10G LR/LW 1310 nm SFP+	10GBASE - LR 1310 nm Single mode (10 km)	-14.4 dBm	1260 to 1565 nm	-6 to -1 dBm	1290 to 1330 nm
G0316A 10G ER/EW 1550 nm 40 km SFP+	10GBASE - ER 1550 nm Single mode (40 km)	-15.8 dBm	1260 to 1565 nm	-3 to 3 dBm	1530 to 1560 nm
G0318A 10G ZR/ZW 1550 nm 80 km SFP+	10GBASE - ER 1550 nm Single mode (80 km)	-22 dBm	1260 to 1565 nm	0 to 5 dBm	1525 to 1565 nm
G0319A Up to 2.7G 1310 nm 15 km SFP	STM-1/-4/-16 short haul, 1310 nm (15 km)	-18 dBm	1270 to 1580 nm	-5 to 0 dBm	1260 to 1360 nm
G0320A Up to 2.7G 1310 nm 40 km SFP	STM-1/-4/-16 long haul, 1310 nm (40 km)	-27 dBm	1270 to 1580 nm	-2 to 3 dBm	1280 to 1335 nm
G0321A Up to 2.7G 1550 nm 80 km SFP	STM-1/-4/-16 long haul, 1550 nm (80 km)	-28 dBm	1270 to 1580 nm	-2 to 3 dBm	1500 to 1580 nm
G0322A 1G/2G/4G FC 1310 nm SFP	1GFC, 2GFC, 4GFC 1310 nm (10 km)	-18 dBm	1260 to 1360 nm	-8 to 0 dBm	1260 to 1360 nm
G0323A 1G/2G/4G FC 1550 nm SFP	1GFC, 2GFC, 4GFC 1550 nm (40 km)	-18 dBm	1470 to 1600 nm	0 to 5 dBm	1510 to 1590 nm
G0328A 1G/2G/4G FC 850 nm SFP	1GFC, 2GFC, 4GFC 850 nm (0.5 km)	-15 dBm	830 to 860 nm	-9 to 0 dBm	830 to 860 nm
G0329A 10G LR 1310 nm SFP+	10GBASE - LR 1310 nm Single mode (10 km)	-14 dBm	1260 to 1355 nm	-8.2 to 0.5 dBm	1260 to 1355 nm
G0332A 100 M FX 1310 nm MM SFP	100BASE-FX 1310 nm Multi mode (2 km)	-31 dBm	1270 to 1600 nm	-20 to -15 dBm	1280 to 1380 nm
G0333A * 10G SR/SW 850 nm SFP+	10GBASE - SR 850 nm Multi mode (0.3 km)	-11.1 dBm	840 to 860 nm	-7.3 to -1 dBm	840 to 860 nm

Specifications

Order No./ Name	Description (Approx. Distance)	Min. Input Sensitivity	Input Wavelength	Output Power	Output Wavelength
G0356A 8G FC/10G SR 850 nm SFP+	8G FC/10G SR 850 nm SFP+	-11.1 dBm	840 to 860 nm	-8.2 to -1 dBm	840 to 860 nm

*: For MU100010A only

Specification of optical modules purchased from Anritsu for the MU100011A with LC connectors (subject to change without further notice):

Order No./ Name	Description (Approx. Distance)	Min. Input Sensitivity	Input Wavelength	Output Power	Output Wavelength
G0334A 40G LR4 1310 nm QSFP+	40G Ethernet/OTN Single mode 1310 nm (10 km)	-11.5 dBm per Lane	1264.5 to 1277.5 nm 1284.5 to 1297.5 nm 1304.5 to 1317.5 nm 1324.5 to 1337.5 nm	Total: 8.3 dBm max. -2 to 2.3 dBm per Lane	1264.5 to 1277.5 nm 1284.5 to 1297.5 nm 1304.5 to 1317.5 nm 1324.5 to 1337.5 nm
G0359A 40G SR4 850 nm QSFP+	40GBASE-SR4 Multi mode 850 nm (0.1 km)	-9.9 dBm	840 to 860 nm	-8 to 2.4 dBm	840 to 860 nm
G0364A 100G LR4 1310 nm QSFP28	100G Ethernet/OTN Single mode 1310 nm (10 km)	-8.6 dBm per Lane	1294.53 to 1296.59 nm 1299.02 to 1301.09 nm 1303.54 to 1305.63 nm 1308.09 to 1310.19 nm	Total: 10.5 dBm max. -4.3 to 4.5 dBm per Lane	1294.53 to 1296.59 nm 1299.02 to 1301.09 nm 1303.54 to 1305.63 nm 1308.09 to 1310.19 nm
G0365A 100G LR4 Dual Rate 1310 nm QSFP28	100G Ethernet/OTN Single mode 1310 nm (10 km)	-8.4 dBm per Lane	1294.53 to 1296.59 nm 1299.02 to 1301.09 nm 1303.54 to 1305.63 nm 1308.09 to 1310.19 nm	Total: 10.0 dBm max. -0.6 to 4.0 dBm per Lane	1294.53 to 1296.59 nm 1299.02 to 1301.09 nm 1303.54 to 1305.63 nm 1308.09 to 1310.19 nm
G0366A 100G 850 nm QSFP28	100G Ethernet Multi mode 850 nm (0.1 km)	-9.9 dBm per Lane	840 to 860 nm	Total: 8.9 dBm max. -9.1 to 2.4 dBm per Lane	840 to 860 nm
G0369A 100G LR4 Dual Rate 1310 nm CFP4	100G Ethernet/OTN Single mode 1310 nm (10 km)	-8.6 dBm per Lane	1294.53 to 1296.59 nm 1299.02 to 1301.09 nm 1303.54 to 1305.63 nm 1308.09 to 1310.19 nm	Total: 10.5 dBm max. -4.3 to 4.5 dBm per Lane	1294.53 to 1296.59 nm 1299.02 to 1301.09 nm 1303.54 to 1305.63 nm 1308.09 to 1310.19 nm

Order No./ Name	Description (Approx. Distance)	Min. Input Sensitivity	Input Wavelength	Output Power	Output Wavelength
G0386A 16G FC SR 850 nm SFP+	16G FC Multi mode 850 nm (0.035 km)	-10.5 dBm	840 to 860 nm	-7.8 dBm or greater	840 to 860 nm
G0387A 16G FC LR 1310 nm SFP+	16G FC Single mode 1310 nm (10 km)	-12.0 dBm	1295 to 1325 nm	-5.0 to +2.0 dBm	1295 to 1325 nm
G0388A 25G SR 850nm SFP28	25G Ethernet Multi mode 850 nm (0.1 km)	-10.3 dBm	840 to 860 nm	-8.4 to +2.4 dBm	840 to 860 nm
G0389A 25G LR 1310nm SFP28	25G Ethernet Single mode 1310 nm (10 km)	-13.3 dBm	1260 to 1350 nm	-7 to +2 dBm	1295 to 1325 nm

13 Support

This chapter contains information about general maintenance of the Network Master. It also contains information on how to obtain support or service assistance.

13.1 Maintenance and Cleaning

This section contains information about general maintenance and cleaning of the Network Master.

13.1.1 Maintenance

The Network Master does not require any regular adjustments.

Using the Network Master in a normal environment and under normal conditions will not call for general maintenance.

WARNING

There are no user-serviceable parts in the Network Master. Possible service or repair should be performed by Anritsu authorized personnel only.

13.1.2 Cleaning

From time to time the Network Master needs to be cleaned. The surfaces of the Network Master can be cleaned with any mild detergent that does not contain solvents.

Before any cleaning, please take notice of the warnings below:

WARNING

Disconnect the Network Master from the mains power connection before any cleaning involving fluid.

- Only use a soft cloth moisturized with a mild detergent to clean the surface of the touch screen.
 - Clean the main power adapter regularly. If dust accumulates around the power pins, there is a risk of fire.
 - Keep the cooling fan clean so that the ventilation holes are not obstructed. If the ventilation is obstructed, the cabinet may overheat and catch fire.
-

13.1.3 Storage

Wipe off dust, fingerprint marks, stains, spots, etc. from the surface of the Network Master before storing it. Avoid storing the Network Master in these places

- In direct sunlight for extended periods
- Outdoors
- In excessively dusty locations
- Where condensation may occur
- In liquids, such as water, oil, or organic solvents, and medical fluids, or places where these liquids may adhere
- In salty air or in place chemically active gases (sulfur dioxide, hydrogen sulfide, chlorine, ammonia, nitrogen dioxide, or hydrogen chloride etc.) are present
- Where toppling over may occur

- In the presence of lubricating oil mists
- In places at an altitude of more than 2 000 m
- In the presence of frequent vibration or mechanical shock, such as in cars, ships, or airplanes
- Places with temperatures and relative humidity in the following ranges:

Temperature range of $\leq -20^{\circ}\text{C}$ or $\geq +50^{\circ}\text{C}$

Humidity range of $\geq 90\%$

Recommended storage conditions

It is recommended that the Network Master be stored in a place that meets the ambient conditions suggested above, plus the following conditions, if it is not to be used for a long period of time:

- Temperature: 5 to 30°C
- Humidity: 40 to 75%
- Little temperature and humidity fluctuations within one day

13.2 Calibration

MT1000A, MU100010A, MU100011A, and MU100090A do not require any calibration in the meaning of adjustment after shipment from factory.

When the MU100090A is capturing GPS satellites, built-in Rubidium oscillator is disciplined to the UTC by using the GPS signal. By this operation, 10 MHz clock and 1PPS are adjusted. The MU100090A 1PPS and 10 MHz are disciplined to the UTC to align it with the standard second.

When the reference 1PPS is available, the 10 MHz clock and 1PPS can be adjusted by inputting the reference 1PPS to the 1pps Sync In connector.

In order to ensure measurements made by these instruments within the specifications, periodically running performance test (equivalent to the inspections made when shipping) for the instrument. The recommended frequency depends on the particular usage of the instruments, but generally yearly performance test is highly advised.

The final decision on performance verification frequency is to be taken by the user, as performance test verifies past measurements rather than guarantee future measurements.

In the event of this equipment malfunctions, contact an Anritsu Service and Sales office. Contact information can be found on the last page of the printed or in a separate file of the PDF version, of this manual.

The separate file is "A4_address_book_e_****.pdf" stored in the Z1817A Utilities ROM. "*****" of the filename shows numeric characters.

13.3 Formatting the data area in the Network Master

Occasionally it is required to remove customer data from Network Master such as after instrument rental. With Software tools you can format Network Master internal data area.

Two data areas are available: Data area and Property area.

Data area contains user rewritable data. Property area contains system data.

Each area can be formatted with tools stored on a USB memory stick. The tools are stored on the Utilities ROM. Please refer to the following description to format.

To perform Data area formatting, copy

"REFORMAT_DATA_AREA.MT1000_SW" to root of USB memory stick.

To perform Property area formatting, copy

"REFORMAT_PROPERTY_AREA.MT1000_SW" to root of USB memory stick.

Place the format tools in the root of an empty of USB memory stick. To perform both kinds of formattings simultaneously, place both tools in the root together.

Procedure

1. Remove power cable and turn instrument off. Power button turns off.
2. Insert the USB memory stick with the tools in one of the USB Type-A ports.
3. Connect power cable or push power button to turn power on. Then formatting is executed and Network Master will reboot automatically.
4. Remove USB memory stick. The formatting is completed.

13.4 Upgrading the Software



Connect the AC adapter to the Network Master while updating the software. When updating the software with battery operation, make sure that there is 40% (or more) power in the battery of the Network Master.

13.4.1 Installation by using USB memory stick

Visit our website and download the latest version. We have two types of installers as below.

MT1000A_Software with MU100011A: For using MT1000A which module configuration includes MU100011A.

MT1000A_Software: For using MT1000A which module configuration does not include MU100011A.



"MT1000A_Software with MU100011A" is consisted from two files. Copy both files to USB memory stick and perform the installation.

Note that installing "MT1000A_Software" is not able to work the MU100011A. Network Master supports only USB memory sticks formatted in FAT32.

1. Copy the installer onto an empty USB memory stick.
2. If USB memory stick is inserted to the Network Master, remove it. If the Network Master is powered-down while the USB memory stick is still inserted, there is a risk that the USB memory stick may not operate normally after the installation.
3. Press the power button to shut down the Network Master. Never force to power off by holding the power button pressed for several seconds.
4. Remove AC adapter and confirm the power button turns to gray.
5. Insert the USB memory stick into the Network Master.
6. Connect AC adapter to the Network Master.
7. Press the power button to boot the Network Master.

The Network Master will detect the installer stored in the USB memory stick, and start installing the software. After the installation has finished, the Network Master will reboot.

If the software is installed on battery operation without connecting AC adapter, Network Master does not reboot. Press the power button to boot the Network Master.

When installing MT1000A software which includes MU100011A, the installation of MU100011A data starts automatically at the Network Master rebooting.

8. Check the software version at [System Information](#) on the **Instrument Toolbar**.
9. Remove USB memory stick after the installation has completed.

13.4.2 Installation via Network

1. Install MX100001A MT1000A/MT1100A Control Software to PC by referring to 3.5.1 [Installation of Control Software](#).
2. Configure the Control Software and the Network Master so that they can communicate via Ethernet by referring to 3.5.2 [Connection and Setup](#).
3. Upgrade the software by referring to 3.5.5 [Remote Upgrade](#).

13.5 Support and Service Assistance

In case your Network Master needs support or service, follow the instructions given in the sub-sections below.

13.5.1 Before you obtain assistance





To ensure fast help the Anritsu or the Anritsu representative need detailed information about the Network Master and the problems concerning the Network Master. The minimum information required is listed below:

- A file containing the system information. The file can be generated using the  icon in the *instrument toolbar*.
- Possible error code displayed on the touch screen, or any other error indications
- A detailed description of the problem and how it occurred. Please make the description as detailed as possible, e.g. by drawing an illustration and/or saving relevant screen captures.

13.5.2 Data Backup

Data in mass storage may be deleted when servicing the Network Master. Before asking the support, backup the data according to following procedures.

Backup to USB Memory Stick

1. Insert the USB Memory Stick to the USB port of the Network Master.
2. Touch  on Instrument Toolbar.
3. Touch **Selection Mode** so that multiple files can be selected.
4. Touch Internal in left pane.
5. Touch all files displayed in right pane.
6. Touch **Copy** ().
7. Touch Usb in left pane.
8. Touch **Paste** ().
9. Touch Internal twice to display folders.
10. Touch a folder and copy it.
11. Touch Usb.
12. Touch **Paste** (). Copy all folders to the USB Memory Stick.

Backup via USB Interface

1. Close all applications by touching  on the Application Tool Bar.
2. Connect the USB cable between PC and USB type B connector of the Service Interface.
3. If PC has detected the Network Master, copy files or folders to PC using PC software (Explorer of Windows etc.).

13.5.3 Obtaining Support or Service Assistance

In the event of this equipment malfunctions, contact an Anritsu Service and Sales office. Contact information can be found on the last page of the printed version of this manual, and is available in a separate file on the PDF version.

13.6 Transporting and Disposal

This section describes the precautions to observe when transporting and disposing of the main frame at the end of its useful life.

13.6.1 Repackaging

Use the original shipping materials, or an approved optional transit case, when repacking the unit for transport. Repack according to the following procedure when the original shipping materials (or a transit case) are not available.

1. Procure a corrugated cardboard, wooden, or aluminum box large enough to pack in cushioning material around the unit.
2. Wrap the main frame in some material such as plastic sheeting that will prevent entry of dust and water.
3. Place the unit into the box.
4. Pack soft materials around the main frame so that it cannot slide around inside the packing box.
5. Secure the outside of the box with packaging cord, adhesive tape, bands, or other such implements.

13.6.2 Transporting

In addition to preventing vibration as much as possible, transport under conditions meeting the storage conditions outlined above.

Transporting MU100090A

The MU100090A contains the parts which is damaged easily by vibration or shock. Avoid putting the MU100090A directly on the carrying car etc. Take the measures against vibration and shock such as wrapping with cushioning.

13.6.3 Disposal

When the Network Master has reached the end of its useful life, dispose of it in accordance with local environmental regulations. Before disposal, dismantle or physically destroy any non-volatile memory media in the Network Master to ensure that data in memory cannot be recovered by third parties.

13.7 Special Information

13.7.1 Equipment Certificate

Anritsu Corporation certifies that this equipment was tested before shipment using calibrated measuring instruments with direct traceability to public testing organizations, and was found to meet the published specifications.

13.7.2 Anritsu Warranty

Anritsu Corporation will repair this equipment free-of-charge if a malfunction occurs within one year after shipment due to a manufacturing fault. However, software fixes will be made in accordance with the separate Software End-User License Agreement. Moreover, Anritsu Corporation will deem this warranty void when:

- The fault is outside the scope of the warranty conditions separately described in the operation manual.
- The fault is due to mishandling, misuse, or unauthorized modification or repair of the equipment by the customer.
- The fault is due to severe usage clearly exceeding normal usage.
- The fault is due to improper or insufficient maintenance by the customer.
- The fault is due to natural disaster, including fire, wind, flooding, earthquake, lightning strike, or volcanic ash, etc.
- The fault is due to damage caused by acts of destruction, including civil disturbance, riot, or war, etc.
- The fault is due to explosion, accident, or breakdown of any other machinery, facility, or plant, etc.
- The fault is due to use of non-specified peripheral or applied equipment or parts, or consumables, etc.
- The fault is due to use of a non-specified power supply or in a non-specified installation location.
- The fault is due to use in unusual environments(Note).
- The fault is due to activities or ingress of living organisms, such as insects, spiders, fungus, pollen, or seeds.

In addition, this warranty is valid only for the original equipment purchaser. It is not transferable if the equipment is resold.

Anritsu Corporation shall assume no liability for injury or financial loss of the customer due to the use of or a failure to be able to use this equipment.

Note:

For the purpose of this Warranty, "unusual environments" means use:

- In places of direct sunlight
- In dusty places
- In liquids, such as water, oil, or organic solvents, and medical fluids, or places where these liquids may adhere
- In salty air or in places where chemically active gases (sulfur dioxide, hydrogen sulfide, chlorine, ammonia, nitrogen dioxide, or hydrogen chloride etc.) are present
- In places where high-intensity static electric charges or electromagnetic fields are present

- In places where abnormal power voltages (high or low) or instantaneous power failures occur
- In places where condensation occurs
- In the presence of lubricating oil mists
- In places at an altitude of more than 2,000 m
- In the presence of frequent vibration or mechanical shock, such as in cars, ships, or airplanes

13.7.3 Anritsu Corporation Contact

In the event of this equipment malfunctions, contact an Anritsu Service and Sales office. Contact information can be found on the last page of the printed version of this manual, and is available in a separate file on the PDF version.

13.7.4 Licensing Information

This product includes copyrighted third-party software licensed under the terms of the GNU General Public License.

Please see the GNU General Public License for the exact terms and conditions of this license.

Especially the following parts of this product are subject to GNU GPL:

- The Linux operating system kernel
- The busybox swiss army knife of embedded linux
- e2fsprogs - filesystem utilities for use with the ext2 filesystem

All listed software packages are copyrighted by their respective authors. Please see the source code for detailed information.

13.7.5 Availability of Source Code

Anritsu Corporation has the full source code of the GPL licensed software, including any scripts to control compilation of the object code.

13.8 Software License Document

Network Master comes with the package software as described in following Table. Note, however, that the package software is not covered by the Anritsu Software License Agreement.

Go to the following website for details of each license.

<https://www.anritsu.com/en-US/test-measurement/support/downloads/manuals/dwl16668>

Software License

Name	Version	License
ace_tao	2.2a	custom
alsa-lib	1.0.24.1	LGPL
alsa-utils	1.0.24.2	GPL
atk	2.10.0-1	LGPL
at-spi	1.32.0-5	GPL
at-spi2-atk	2.10.2-1	GPL2
at-spi2-core	2.10.2-1	GPL2
attr	2.4.47-1	LGPL
avahi	0.6.31-11	LGPL
bash	2.05b	GPL2
binutils	2.24-1	GPL
bluez	4.101	GPL
bluez-tools	0.1.38	GPL
busybox	1.20.2	GPL2
cairo	1.12.16-1	LGPL,MPL
compositeproto	0.4	MIT
coreutils	8.23-1	GPL3
cups-filters	1.0.41-1	GPL
damageproto	1.1.0	MIT
dbus	1.4.14	GPL,custom
dbus-glib	0.82	GPL2,custom
DirectFB	1.4.0	LGPL
dosfstools	3.0.26-1	GPL2
e2fsprogs	1.41.4	GPL
expat	2.0.1	MIT
fontconfig	2.11.0-1	custom
font-util	1.0.1	MIT
freetype	2.3.9	GPLorFTL
gdb	6.6	GPL
gdk-pixbuf2	2.30.2-1	LGPL2.1
glib	1.2.10-11	LGPL
glib2	2.38.2-1	LGPL
glibc	2.17-5.1	GPL,LGPL

Software License (Continued)

Name	Version	License
gmp	5.1.3-2	LGPL3
gnutls	3.2.7-1	GPL3,LGPL2.1
graphite	1:1.2.4-1	LGPL,GPL,custom
gsettings-desktop-schemas	3.10.1-1	GPL
gtk2	2.14.3	LGPL
gtk3	3.10.6-1	LGPL
gzip	1.6-1	GPL3
harfbuzz	0.9.24-1	MIT
hicolor-icon-theme	0.12-2	GPL2
hplip	3.14.1	custom
icewm	1.3.7	GPL
inputproto	1.4.4	MIT
jack	0.121.3-7	GPL,LGPL
kbproto	1.0.3	MIT
keyutils	1.5.8-1	GPL2,LGPL2.1
kobs-ng	12.09.01	GPL
krb5	1.11.4-1	custom
lcms2	2.5-2	MIT
libcap	2.22-5	GPL2
libcups	1.7.0-2	GPL
libdbus	3.5.7	GPL,custom
libdrm	2.3.1	MIT
liberation-fonts	20070509	GPL+exception
libffi	3.0.13-4	MIT
libfontenc	1.0.4	MIT
libgcrypt	1.5.3-1	LGPL
libgpg-error	1.12-1	LGPL
libICE	1.0.4	MIT
libidn	1.28-2	GPL3,LGPL
libjpeg-turbo	1.3.0-3	GPL,custom
liblzma	5.0.5-2	PublicDomain
libnfnetwork	0.0.25	GPL
libnl	3.4.0	LGPLv2.1
libpciaccess	0.10.6	MIT
libpng	1.6.7-1	custom
libpthread-stubs	0.1	MIT
libSM	1.0.2	MIT
libtasn1	3.4-1	GPL3,LGPL
libtermcap	2.0.8	LGPL
libtiff	4.0.3-4	custom
libusbx	1.0.17-1	LGPL

Software License (Continued)

Name	Version	License
libx11	1.6.2-1	custom
libXau	1.0.4	MIT
libXaw	1.0.4	MIT
libxcb	1.9.1-2	custom
libxcomposite	0.4.4-1	custom
libxcursor	1.1.14-1	custom
libXext	1.0.4	MIT
libXfixes	4.0.3	MIT
libXfont	1.3.3	MIT
libXft	2.1.13	MIT
libxi	1.7.2-1	custom
libxinerama	1.1.3-2	custom
libxkbcommon	0.3.2-1	custom
libxkbfile	1.0.5	MIT
libxml2	2.6.28	MIT
libXmu	1.0.4	MIT
libXpm	3.5.7	MIT
libXrandr	1.3.0	MIT
libXrender	0.9.4	MIT
libXt	1.0.4	MIT
libxtst	1.2.2-1	custom
libxxf86vm	1.1.3-1	custom
linux-gpib	3.2.20	GPL2
linux_kernel	3.0.35	GPL2
lua	5.2.3-1	MIT
lwip	2.0.3	BSD
merge	0.1	GPL
mesa	10.0.1-1	custom
mesa-libgl	10.0.1-1	custom
modeps	1	GPL
ncurses	5.9-6	MIT
nettle	2.7.1-1	GPL2
newfs_msdos	1.33	BSD
obexftp	0.23	LGPL
openobex	1.5	LGPL
openssl	1.1.0f	Apache License 2
p11-kit	0.20.1-1	BSD
pango	1.36.1-1	LGPL
pcre	8.34-1	BSD
perf	3.0.35	GPL
pixman	0.32.4-1	custom

Software License (Continued)

Name	Version	License
poppler	0.26.4-1	GPL
poppler-data	0.4.6-1	custom,GPL2
poppler-qt4	0.26.3-1	GPL
portaudio	19_20111121-	custom
portmap	5beta	BSD
qt4	4.8.2	GPL3,LGPL,FDL,custom
qwt	6.1.0rc3	LGPL
randrproto	1.2.2	MIT
readline	6.2.004-2	GPL
recordproto	1.13.2	MIT
renderproto	0.9.3	MIT
resourceproto	1.0.2	MIT
samba	3.6.23	GPL3
scrnssaverproto	1.1.0	MIT
talloc	2.1.1-1	GPL3
tcpdump	4.5.1-1	BSD
tcp_wrappers	7.6	BSD
timezone	2006n	BSD
tslib	1	LGPL
u-boot	Jan-13	GPL
udev	117	GPL
wayland	1.3.0-1	MIT
wget	1.15-1	GPL3
wireless_tools	29	GPL
wireshark	1.12.1	GPL2
wpa_supplicant	2.6	BSD
x11vnc	0.9.13-6	GPL2
xcb-proto	1.2	MIT
xcmiscproto	1.1.2	MIT
xextproto	7.0.3	MIT
xf86bigfontproto	1.1.2	MIT
xf86driproto	2.0.4	MIT
xorg-server	1.6.1	MIT
xorg-x11-drv-keyboard	1.3.2	MIT
xorg-x11-drv-mouse	1.4.0	MIT
xorg-x11-proto-devel	7.5	MIT
xorg-x11-xkb-utils	7.2	MIT
xproto	7.0.13	MIT
xterm	234	MIT
xtrans	1.2.3	MIT
zlib	1.2.8	zlibv

13.9 EULA License Document

Software End-User License Agreement (EULA)

Please read this Software End-User License Agreement (hereafter this EULA) carefully before using (includes executing, copying, registering, etc.) this software (includes programs, databases, scenarios, etc., used to operate, set, etc., Anritsu electronic equipment). By reading this EULA and using this software, you are agreeing to be bound by the terms of its contents and Anritsu Corporation (hereafter Anritsu) hereby grants you the right to use this Software with the Anritsu-specified equipment (hereafter Equipment) for the purposes set out in this EULA.

1. Grant of License and Limitations

1. Regardless of whether this Software was purchased from or provided free-of-charge by Anritsu, you agree not to rent, lease, lend, or otherwise distribute this Software to third parties and further agree not to disassemble, recompile, reverse engineer, modify, or create derivative works of this Software.
2. You may make one copy of this Software for backup purposes only.
3. You are not permitted to reverse engineer this software.
4. This EULA allows you to install one copy of this Software on one piece of Equipment.

2. Disclaimers

To the extent not prohibited by law, in no event shall Anritsu be liable for personal injury, or any incidental, special, indirect or consequential damages whatsoever, including, without limitation, damages for loss of profits, loss of data, business interruption or any other commercial damages or losses, arising out of or related to your use or inability to use this Software.

3. Limitation of Liability

- a. If a fault (bug) is discovered in this Software, preventing operation as described in the operation manual or specifications whether or not the customer uses this software as described in the manual, Anritsu shall at its own discretion, fix the bug, or exchange the software, or suggest a workaround, free-of-charge. However, notwithstanding the above, the following items shall be excluded from repair and warranty.
 - i. If this Software is deemed to be used for purposes not described in the operation manual or specifications.
 - ii. If this Software is used in conjunction with other non-Anritsu-approved software.
 - iii. Recovery of lost or damaged data.
 - iv. If this Software or the Equipment has been modified, repaired, or otherwise altered without Anritsu's prior approval.
 - v. For any other reasons out of Anritsu's direct control and responsibility, such as but not limited to, natural disasters, software virus infections, etc.
- b. Expenses incurred for transport, hotel, daily allowance, etc., for on-site repairs by Anritsu engineers necessitated by the above faults shall be borne by you.
- c. The warranty period for faults listed in article 3a above covered by this EULA shall be either 6 months from the date of purchase of this Software or 30 days

after the date of repair, whichever is longer.

4. Export Restrictions

You may not use or otherwise export or re-export directly or indirectly this Software except as authorized by Japanese and United States law. In particular, this software may not be exported or re-exported (a) into any Japanese or US embargoed countries or (b) to anyone on the Japanese or US Treasury Department's list of Specially Designated Nationals or the US Department of Commerce Denied Persons List or Entity List. By using this Software, you warrant that you are not located in any such country or on any such list. You also agree that you will not use this Software for any purposes prohibited by Japanese and US law, including, without limitation, the development, design and manufacture or production of missiles or nuclear, chemical or biological weapons of mass destruction.

5. Termination

Anritsu shall deem this EULA terminated if you violate any conditions described herein. This EULA shall also be terminated if the conditions herein cannot be continued for any good reason, such as violation of copyrights, patents, or other laws and ordinances.

6. Reparations

If Anritsu suffers any loss, financial or otherwise, due to your violation of the terms of this EULA, Anritsu shall have the right to seek proportional damages from you.

7. Responsibility after Termination

Upon termination of this EULA in accordance with item 5, you shall cease all use of this Software immediately and shall as directed by Anritsu either destroy or return this Software and any backup copies, full or partial, to Anritsu.

8. Dispute Resolution

If matters of dispute or items not covered by this EULA arise, they shall be resolved by negotiations in good faith between you and Anritsu.

9. Court of Jurisdiction

This EULA shall be interpreted in accordance with Japanese law and any disputes that cannot be resolved by negotiation described in Article 8 shall be settled by the Japanese courts.

13.10 CE Conformity Marking

Anritsu affixes the CE conformity marking on the following product(s) in accordance with the Decision 768/2008/EC to indicate that they conform to the EMC, LVD, and RoHS directive of the European Union (EU).

CE marking



13.10.1 Product Model

Model:
MT1000A Network Master Pro

13.10.2 Applied Directive

EMC:
Directive 2014/30/EU
LVD:
Directive 2014/35/EU
RoHS:
Directive 2011/65/EU

13.10.3 Applied Standards

EMC:
Emission: EN 61326-1: 2013 (Class A)
Immunity: EN 61326-1: 2013 (Table 2)

Standard	Performance Criteria*
IEC 61000-4-2 (ESD)	B
IEC 61000-4-3 (EMF)	A
IEC 61000-4-4 (Burst)	B
IEC 61000-4-5 (Surge)	B
IEC 61000-4-6 (CRF)	A
IEC 61000-4-8 (RPFMF)	A
IEC 61000-4-11 (V dip/short)	B, C

*: Performance Criteria

- A. The equipment shall continue to operate as intended during and after the test. No degradation of performance or loss of function is allowed below a performance level specified by the manufacturer, when the equipment is used as intended. The performance level may be replaced by a permissible loss of performance. If the minimum performance level or the permissible performance loss is not specified by the manufacturer, either of these may be derived from the product description and documentation and what the user may reasonably expect from the equipment if used as intended.
- B. The equipment shall continue to operate as intended after the test. No degradation of performance or loss of function is allowed below a performance level specified by the manufacturer, when the equipment

is used as intended. The performance level may be replaced by a permissible loss of performance. During the test, degradation of performance is however allowed. No change of actual operating state or stored data is allowed. If the minimum performance level or the permissible performance loss is not specified by the manufacturer, either of these may be derived from the product description and documentation and what the user may reasonably expect from the equipment if used as intended.

- C. Temporary loss of function is allowed, provided the function is self-recoverable or can be restored by the operation of the controls.

Harmonic current emissions:

EN 61000-3-2:2014 (Class A equipment)

LVD:

EN 61010-1:2010 (Pollution Degree 2)

RoHS:

EN 50581:2012 (Category 9)

If the third digit of the serial number is "7", the product complies with Directive 2011/65/EU as amended by (EU) 2015/863.

(Pb,Cd,Cr6+,Hg,PBB,PBDE,DEHP,BBP,DBP,DIBP)

If the third digit of the serial number is "6", the product complies with Directive 2011/65/EU.

(Pb,Cd,Cr6+,Hg,PBB,PBDE)

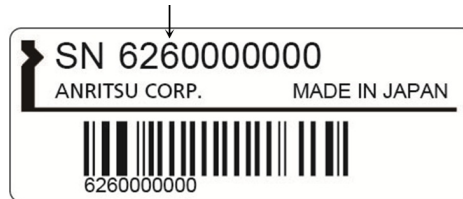

Serial number example

13.10.4 Contact

Name:	Anritsu GmbH
Address, City:	Nemetschek Haus, Konrad-Zuse-Platz 1 81829 München,
Country:	Germany
Name:	ANRITSU EMEA Ltd
Address, City:	200 Capability Green, Luton Bedfordshire, LU1 3LU
Country:	United Kingdom

13.10.5 CE Declaration

Anritsu
envision : ensure

ANRITSU CORPORATION
5-1-1 Onna, Atsugi-shi, Kanagawa,
243-8555 Japan
Phone: +81 46 223 1111

**DECLARATION of CONFORMITY**

Product: Anritsu Corporation
Model: MT1000A
Serial: 6xxxxxxxxx
Software name and version : Not reconfigurable radio
Accessories : G0385A/G0310A

This declaration of conformity is issued under the sole responsibility of the manufacturer

Means of Conformity

We declare under our sole responsibility that the Product (s) is conformity with the essential requirements and other relevant requirements of the Radio Equipment (RE) Directive (2014/53/EU).

Supplied by

Anritsu Corporation
5-1-1 Onna Atsugi-shi Kanagawa,
243-8555 Japan

Technical File held by

Anritsu Corporation
5-1-1 Onna Atsugi-shi Kanagawa,
243-8555 Japan

Notified Body

N/A

N/A

**RE Directive
(Article 3.1(a) Safety)**

Standard used for comply
EN 60950-1: 2006 + Amd.11: 2009 + Amd.1: 2010 +
Amd.12: 2011
EN 62311: 2008

**RE Directive
(Article 3.1(b) EMC)**

EN 301 489-1 V2.1.1
EN 301 489-17 V3.1.1
EN 61326-1: 2013
EN 61000-3-2: 2014
EN 61000-3-3: 2008

**RE Directive
(Article 3.2 Spectrum)**

EN 300 328 V2.1.1

Date of issue: June 7, 2017

Signature of Responsible Person:

M. Arai

Masato Arai
Director
Anritsu Corporation

No. M3T-1CENMX0001

13.11 RCM Conformity Marking

Anritsu affixes the RCM mark on the following product(s) in accordance with the regulation to indicate that they conform to the EMC framework of Australia/New Zealand.

RCM marking



13.11.1 Product Model

Model:
MT1000A Network Master Pro

13.11.2 Applied Standards

EMC:
Emission: EN 61326-1:2013 (Class A equipment)

13.12 Laser Safety

13.12.1 Laser Safety Classifications

Class 1 indicates the danger degree of the laser radiation specified below according to IEC 60825-1:2007.

Class 1:

Lasers that are safe under reasonably foreseeable conditions of operation, including the use of optical instruments for intrabeam viewing.

 **WARNING**

The laser in the plug-in unit provided for this equipment is classified as Class 1 according to the IEC 60825-1:2007 standard, and is safe under reasonably foreseeable operating conditions.

Never use optical instruments to directly view Class 1M laser products. Doing so may result in serious damage to the eyes.

 **CAUTION**

Use of controls or adjustments or performance of procedures other than those specified herein may result in hazardous radiation exposure.

The use of optical instruments with this product will increase eye hazard.

Table 1 Laser Safety Classifications Based on IEC 60825-1:2007







Model Name	Class	Max. Optical Output Power (mW)*	Pulse Width (s)/ Repetition Rate	Emitted Wavelength (nm)	Beam Divergence (deg)	Laser Aperture	Incorporated Laser Specifications
MU100010A	1	0.5	CW	850	31.9	Figure 1,[1],[2]	Table 2 (a)
	1	0.5	CW	1310	11.5		Table 2 (b)
	1	2.0	CW	1550	11.5		Table 2 (c)
MU100010A, MU100011A	1	0.8	CW	1310	11.5	Figure 1,[1],[2] Figure 2,[2],[3]	Table 2 (d)
	1	2.0	CW	1550	11.5		Table 2 (e)
	1	2.0	CW	1550	11.5		Table 2 (f)
	1	1.0	CW	1310	11.5		Table 2 (g)
	1	2.0	CW	1310	11.5		Table 2 (h)
	1	2.0	CW	1550	11.5		Table 2 (i)
	1	1.0	CW	1310	11.5		Table 2 (j)
	1	3.2	CW	1550	11.5		Table 2 (k)
	1	0.6	CW	850	31.9		Table 2 (l)
	1	1.1	CW	1310	11.5		Table 2 (m)
	1	0.04	CW	1310	31.9		Table 2 (n)
MU100010A	1	0.6	CW	850	31.9	Figure 1,[1],[2]	Table 2 (o)
MU100010A, MU100011A	1	0.8	CW	850	31.9	Figure 1,[1],[2] Figure 2,[2],[3]	Table 2 (p)
MU100011A	1M	5.0	CW	850	23.0	Figure 2,[4]	Table 2 (q)
	1	6.8	CW	1310	11.5		Table 2 (r)
	1	11.3	CW	1310	11.5		Table 2 (s)
	1	10.0	CW	1310	11.5		Table 2 (t)
	1M	7.8	CW	850	23.0		Table 2 (u)
	1	11.3	CW	1310	11.5	Figure 2,[1]	Table 2 (v)
	1	0.8	CW	850	23.0	Figure 2,[2],[3]	Table 2 (w)
	1	1.6	CW	1310	11.5		Table 2 (x)
	1M	1.8	CW	850	23.0		Table 2 (y)
1	1.6	CW	1310	11.5		Table 2 (z)	
* Indicates the possible optical output power when each and every reasonably foreseeable single-fault condition is included.							

Table 2 Incorporated Laser of MU100010A and MU100011A

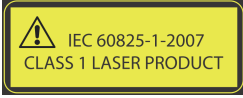
	Incorporated Laser	Max. Optical Output Power (mW)*	Pulse Width (s)/ Repetition Rate	Emitted Wavelength (nm)	Beam Divergence (deg)
(a)	G0311A	0.5	CW	850	31.9
(b)	G0312A	0.5	CW	1310	11.5
(c)	G0313A	2.0	CW	1550	11.5
(d)	G0315A	0.8	CW	1310	11.5
(e)	G0316A	2.0	CW	1550	11.5
(f)	G0318A	2.0	CW	1550	11.5
(g)	G0319A	1.0	CW	1310	11.5
(h)	G0320A	2.0	CW	1310	11.5
(i)	G0321A	2.0	CW	1550	11.5
(j)	G0322A	1.0	CW	1310	11.5
(k)	G0323A	3.2	CW	1550	11.5
(l)	G0328A	0.6	CW	850	31.9
(m)	G0329A	1.1	CW	1310	11.5
(n)	G0332A	0.04	CW	1310	31.9
(o)	G0333A	0.6	CW	850	31.9
(p)	G0356A	0.8	CW	850	31.9
(q)	G0359A	5.0	CW	850	23.0
(r)	G0334A	6.8	CW	1310	11.5
(s)	G0364A	11.3	CW	1310	11.5
(t)	G0365A	10.0	CW	1310	11.5
(u)	G0366A	7.8	CW	850	23.0
(v)	G0369A	11.3	CW	1310	11.5
(w)	G0386A	0.8	CW	850	23.0
(x)	G0387A	1.6	CW	1310	11.5
(y)	G0388A	1.8	CW	850	23.0
(z)	G0389A	1.6	CW	1310	11.5
* Indicates the possible optical output power when each and every reasonably foreseeable single-fault condition is included.					

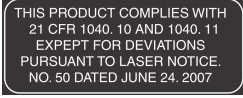
13.12.2 Indication Labels on Product

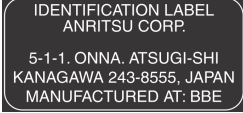
Table 3 Labels on Product

	Type	Label	Affix to	Model Name
1	Explanation		Figure 3,A	MU100010A
2	Explanation		Figure 4,A	MU100011A
3	Certification		Figure 3,B	MU100010A
4	Certification		Figure 4,B	MU100011A
5	Identification		Figure 3,C	MU100010A
6	Identification		Figure 4,C	MU100011A
7	Warning		Figure 3,D	MU100010A

13.12.3 Laser Radiation Markings

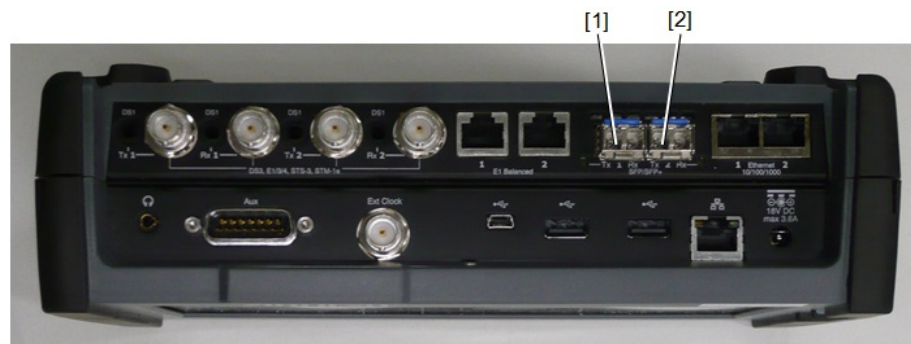

Figure 1: Locations of Laser Beam Aperture (MU100010A)

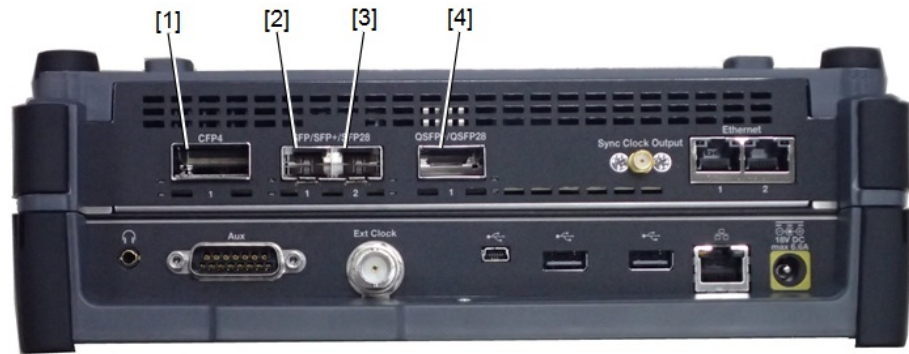

Figure 2: Locations of Laser Beam Aperture (MU100011A)

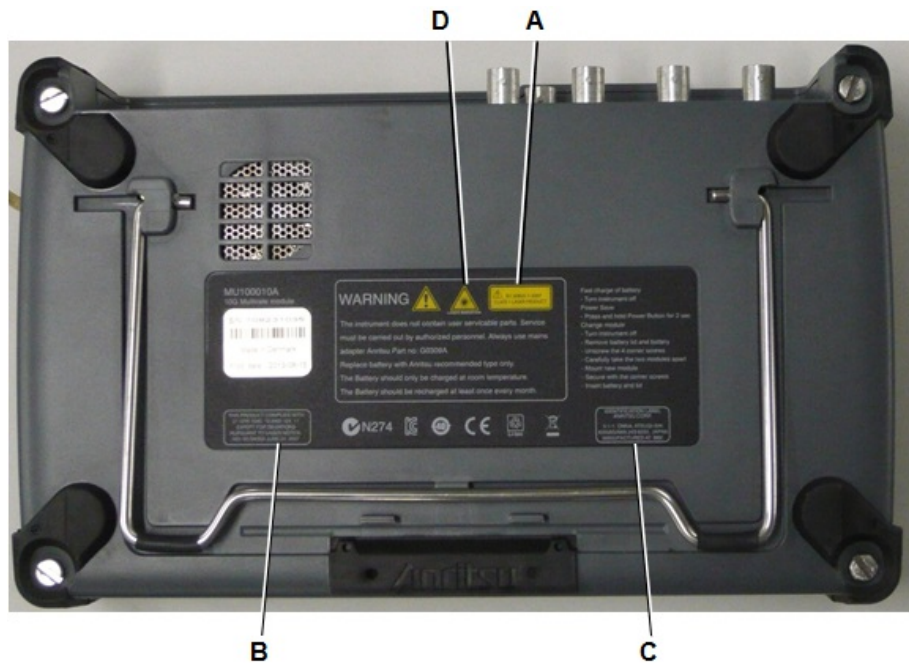

Figure 3: Locations of affixed labels (MU100010A)

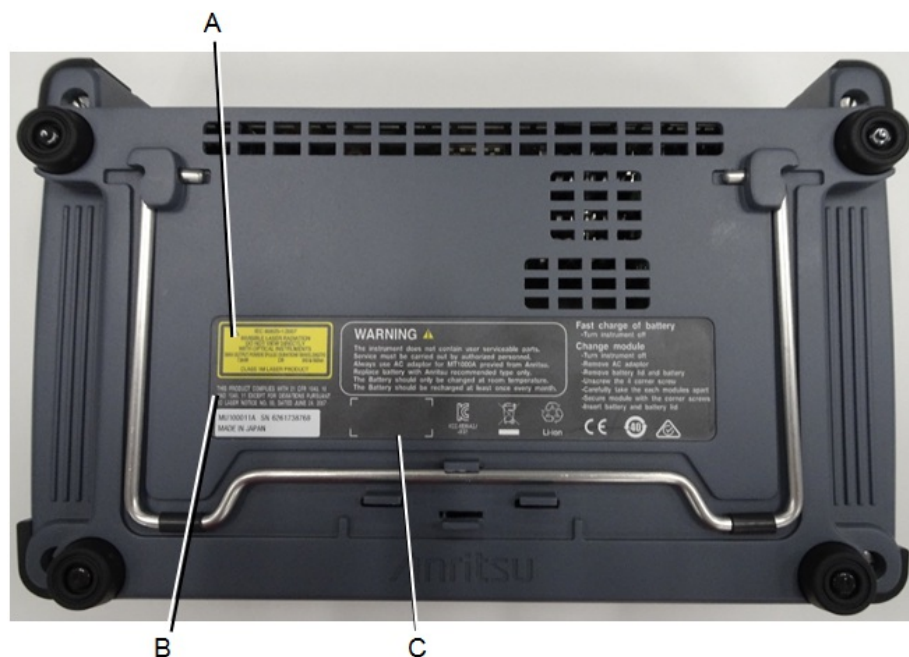

Figure 4: Locations of affixed labels (MU100011A)

13.13 Wireless Certification

13.13.1 Japan MIC



MT1000A has obtained the certification of construction type of specified radio equipment.

13.13.2 North America (USA FCC and Canada IC)

This device complies with Industry Canada license-exempt RSS standard(s).

Operation is subject to the following two conditions:

1. This device may not cause interference.
2. This device must accept any interference, including interference that may cause undesired operation of this device.

Le présent appareil est conforme aux CNR d'Industrie Canada applicables aux appareils radio exempts de licence. L'exploitation est autorisée aux deux conditions suivantes :

1. l'appareil ne doit pas produire de brouillage.
2. l'utilisateur de l'appareil doit accepter tout brouillage radioélectrique subi, même si le brouillage est susceptible d'en compromettre le fonctionnement.

FCC CAUTION

Changes or modifications not expressly approved by the party responsible for compliance could void the user's authority to operate the equipment.

This transmitter must not be co-located or operated in conjunction with any other antenna or transmitter.

The available scientific evidence does not show that any health problems are associated with using low power wireless devices. There is no proof, however, that these low power wireless devices are absolutely safe. Low power Wireless devices emit low levels of radio frequency energy (RF) in the microwave range while being used. Whereas high levels of RF can produce health effects (by heating tissue), exposure of low-level RF that does not produce heating effects causes no known adverse health effects. Many studies of low-level RF exposures have not found any biological effects. Some studies have suggested that some biological effects might occur, but such findings have not been confirmed by additional research. MT1000A has been tested and found to comply with FCC/IC radiation exposure limits set forth for an uncontrolled environment and meets the FCC radio frequency (RF) Exposure Guidelines and RSS-102 of the IC radio frequency (RF) Exposure rules.

Les connaissances scientifiques dont nous disposons n'ont mis en évidence aucun problème de santé associé à l'usage des appareils sans fil à faible puissance. Nous ne sommes cependant pas en mesure de prouver que ces appareils sans fil à faible puissance sont entièrement sans danger. Les appareils sans fil à faible puissance émettent une énergie radioélectrique (RF) très faible dans le spectre des micro-ondes lorsqu'ils sont utilisés. Alors qu'une dose élevée de RF peut avoir des effets sur la santé (en chauffant les tissus), l'exposition à de faibles RF qui ne produisent pas de chaleur n'a pas de mauvais effets connus sur la santé. De nombreuses études ont été menées sur les expositions aux RF faibles et n'ont découvert aucun effet biologique. Certaines études ont suggéré qu'il pouvait y avoir certains effets biologiques, mais ces résultats n'ont pas été confirmés par des recherches supplémentaires. MT1000A a été testé et jugé conforme aux limites d'exposition aux rayonnements énoncées pour un environnement non contrôlé et respecte les règles des radioélectriques (RF) de la FCC lignes directrices d'exposition et d'exposition aux fréquences radioélectriques (RF) CNR-102 de l'IC.

13.13.3 Europe CE



Hereby, Anritsu Corporation, declares that this instrument is in compliance with the essential requirements and other relevant provisions of Directive 1999/5/EC.

13.13.4 Brazil ANATEL

This equipment is certified by ANATEL in accordance with the regulated procedure by Resolution 242/2000 and meets the applicable technical requirements, including exposure limits of Specific Absorption Rate related to electric fields, magnetic and electromagnetic radio frequency, in accordance with the Resolution No. 303/2002 and 533/2009.

This device complies with the RF exposure guidelines when positioned at least 0 cm away from the body. For more information, see the website of ANATEL - www.anatel.gov.br

Este produto está homologado pela Anatel, de acordo com os procedimentos regulamentados pela Resolução n°242/2000 e atende aos requisitos técnicos aplicados, incluindo os limites de exposição da Taxa de Absorção Específica referente a campos elétricos, magnéticos e eletromagnéticos de radiofrequência, de acordo com as Resoluções n° 303/2002 e 533/2009. Este dispositivo está em conformidade com as diretrizes de exposição á radiofrequência quando posicionado a pelo menos 0 centímetros de distância do corpo. Para maiores informações, consulte o site da Anatel - www.anatel.gov.br

13.13.5 China SRRC

- 使用频率: 2.4 - 2.4835 GHz
- 等效全向辐射功率(EIRP):
天线增益 < 10 dBi 时: $\leq 100 \text{ mW}$ 或 $\leq 20 \text{ dBm}$
- 最大功率谱密度:
WLAN: 天线增益 < 10 dBi 时: $\leq 10 \text{ dBm / MHz}$ (EIRP)
Bluetooth: 天线增益 < 10 dBi 时: $\leq 20 \text{ dBm / MHz}$ (EIRP)
- 载频容限: 20 ppm
- 带外发射功率(在 2.4 - 2.4835 GHz 频段以外)
 $\leq -80 \text{ dBm / Hz}$ (EIRP)
- 杂散发射(辐射)功率(对应载波 ± 2.5 倍信道带宽以外):
 $\leq -36 \text{ dBm / 100 kHz}$ (30 - 1000 MHz)
 $\leq -33 \text{ dBm / 100 kHz}$ (2.4 - 2.4835 GHz)
 $\leq -40 \text{ dBm / 1 MHz}$ (3.4 - 3.53 GHz)
 $\leq -40 \text{ dBm / 1 MHz}$ (5.725 - 5.85 GHz)
 $\leq -30 \text{ dBm / 1 MHz}$ (其它 1 - 12.75 GHz)

不得擅自更改发射频率、加大发射功率(包括额外加装射频功率放大器), 不得擅自外接天线或改用其它发射天线;

使用时不得对各种合法的无线电通信业务产生有害干扰; 一旦发现有干扰现象时, 应立即停止使用, 并采取措施消除干扰后方可继续使用;

使用微功率无线电设备, 必须忍受各种无线电业务的干扰或工业、科学及医疗应用设备的辐射干扰;

不得在飞机和机场附近使用。

13.13.6 Indonesia SDPPI

34837/SDPPI/2017 4679

MT1000A is certified SDPPI wireless certification.

13.13.7 Israel MoC

10. תנאים מיוחדים והערות המשרד:

10.1 היבואן ידביק תווית על גוף המכשיר ותווית נוספת על גבי אריזה חיצונית, בהן יהיה רשום:

א. מספר אישור אלחוטני של משרד התקשורת הוא 51-43492.

ב. אסור להחליף את האנטנה המקורית של המכשיר, ולא לעשות בו כל שינוי טכני אחר.

10.2 נדרש להדגיש ללקוח כי השימוש בצידוד זה היינו על פי התנאים הבאים:

- א. נקודות הגישה תהיה מיועדת אך ורק לחיבור משתמש המצוי בחצרים מתוחמים (דוגמת בית, בית עסק, מתחם שדה תעופה, קמפוס אוניברסיטאי וכו')
- ב. לצורך גישה לאינטרנט, נקודת הגישה תקושר מחוץ לחצרים אך ורק אל בעל רשיון למתן שירות גישה לאינטרנט (ISP, להלן-ספק אינטרנט). הקישור לספק אינטרנט יהיה אך ורק באמצעות קו תקשורת נתונים המסופק בידי בעל רשיון למתן שירותי תקשורת נתונים;
- ג. קישור נקודת הגישה מחוץ לחצרים לצורך תקשורת נתונים ייעשה באמצעות תשתיות של בעל רשיון מתאים ובלבד שלא ייעשה שימוש בקישור כאמור לצורך העברת קול (VOICE)
- ד. לצורך שרות לצד ג' נדרש רשיון נוסף מאגף הנדסה ורישוי (משרד התקשורת).

13.13.8 Mexico IFETEL



IFETEL certification number: RCPANMT14-0759

The operation of this equipment is subject to the following two conditions:

1. It is possible that this equipment or device may not cause harmful interference.
2. This equipment or device must accept any interference, including interference that may cause undesired operation.

La operación de este equipo está sujeta a las siguientes dos condiciones :

1. es posible que este equipo o dispositivo no cause interferencia perjudicial.
2. este equipo o dispositivo debe aceptar cualquier interferencia, incluyendo la que pueda causar su operación no deseada.

13.13.9 Philippines NTC

MT1000A is certified NTC wireless certification.

13.13.10 Russia CU Scheme and Minsvyaz



MT1000A is certified CU scheme and Minsvyaz wireless certification.

Contact information:

"Uniservis" Ltd.

1st Vladimirovskaya street, building 20A, 1st floor, premises 1, room 17,
Moscow 111123, Russia. OGRN 5107746076873.

13.13.11 Singapore IMDA

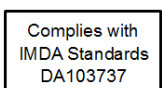

MT1000A is certified IMDA wireless certification.

13.13.12 Thailand NTC

This telecommunication equipment is in compliance with NTC requirements.

13.14 Declarations

13.14.1 Notes on Export Management

This product and its manuals may require an Export License/Approval by the Government of the product's country of origin for re-export from your country.

Before re-exporting the product or manuals, please contact us to confirm whether they are export-controlled items or not.

When you dispose of export-controlled items, the products/manuals need to be broken/shredded so as to be unlawfully used for military purposes.

13.14.2 Information for EU and EFTA Customers Only

Please recycle the battery

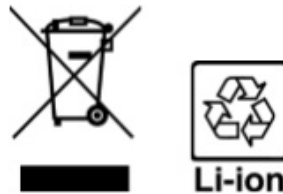

The product that you have purchased contains a rechargeable battery. The battery is recyclable. At the end of its useful life, under various state and local laws, it may be illegal to dispose of this battery into the municipal waste. Check with your local solid-waste disposal officials for details of recycling options or proper disposal in your area.

Before disposing of this product, discharge the battery and mail it to your Anritsu Service or Sales office.

1. Disconnect the AC adapter, if used.
2. Turn the power switch to on.
3. Leave the product on until the power indicator goes off; the battery is now discharged.
4. Remove the battery.
5. Insulate the battery terminals with adhesive tape.
6. Please recycle in accordance with your national or regional legislation.



*Equipment marked with the Crossed-out Wheeled Bin Symbol complies with council directive 2012/19/EU (the "WEEE directive") in European Union.
For products placed on the EU market after August 13, 2005, please contact your local Anritsu representative at the end of the product's useful life to arrange disposal in accordance with your initial contract and the local law.*

13.14.3 Information for U.S. Customers Only

Please recycle the battery



The product that you have purchased contains a rechargeable battery. The battery is recyclable. At the end of its useful life, under various state and local laws, it may be illegal to dispose of this battery into the municipal waste stream. Check with your local solid waste officials for details in your area for recycling options or proper disposal.

Before disposing of this product, discharge the battery and mail it to your Anritsu Service or Sales office.

1. Attach the battery pack to the product.
2. Disconnect the AC adapter, if used.
3. Turn the power switch to ON.
4. Leave the product on until the power indicator goes off; the battery is now discharged.
5. Remove the battery.
6. Insulate the battery terminals with adhesive tape.
7. Mail it to your Anritsu Service or Sales office, or to the address shown below.

ANRITSU COMPANY
490 Jarvis Drive, Morgan Hill, CA 95037-2809, USA

13.14.4 Information for the Chinese Market Only

Concerning declaration of China RoHS, please see the note below.



*China RoHS is not 100% identical to the European (EU) RoHS. EU RoHS has exemptions for Pb and Hg in various alloys, soldering, displays and other products. The China RoHS declaration in the next table does **NOT** comply with EU RoHS.*

产品中有毒有害物质或元素的名称及含量

部件名称	有毒有害物质或元素					
	铅 (Pb)	汞 (Hg)	镉 (Cd)	六价铬 [Cr(VI)]	多溴联苯 (PBB)	多溴二苯醚 (PBDE)
印刷线路板 (PCA)	×	○	×	×	○	○
机壳、支架 (Chassis)	×	○	×	×	○	○
LCD	×	×	×	×	○	○
其他 (电缆、风扇、连接器等) (Appended goods)	×	○	×	×	○	○

○：表示该有毒有害物质在该部件所有均质材料中的含量均在 SJ/T11363-2006 标准规定的限量要求以下。
×：表示该有毒有害物质至少在该部件的某一均质材料中的含量超出 SJ/T11363-2006 标准规定的限量要求。

环保使用期限

这个标记是根据 2006/2/28 公布的「电子信息产品污染控制管理办法」以及 SJ/T 11364-2006 「电子信息产品污染控制标识要求」的规定，适用于在中国销售的电子信息产品的环保使用期限。仅限于在遵守该产品的安全规范及使用注意事项的基础上，从生产日起算的该年限内，不会因产品所含有害物质的泄漏或突发性变异，而对环境污染，人身及财产产生深刻地影响。
注) 电池的环保使用期限是 5 年。